



KIT KVD-1 S2 E-COMPACT



SISTEMA DIGITAL COAXIAL

HI-204/1
10/16
24Vdc

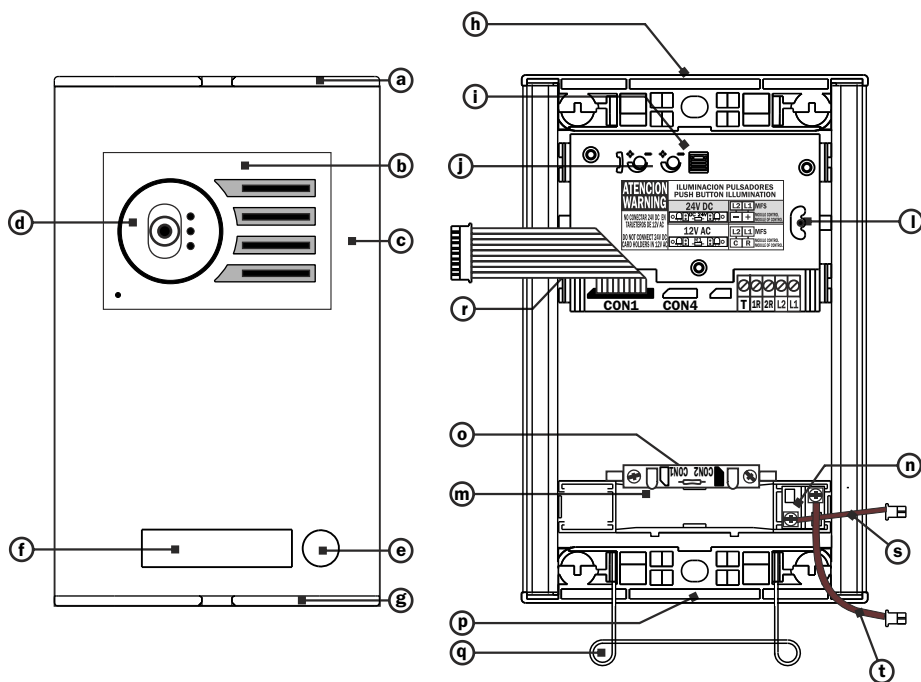

- a) **Cabezal superior.**/Grey top head
- b) **Rejilla del módulo de fonía.**/Audio module grill
- c) **Placa de aluminio.**/Aluminium extruded
- d) **Telecámara.**/Camera module
- e) **Pulsador de llamada.**/Call push-button
- f) **Tarjetero de identificación.**/Identification cardholder
- g) **Cabezal inferior.** /Grey bottom head
- h) **Fijación superior a caja de empotrar.**/Top fixing to the mounting box
- i) **Módulo de fonía.**/Audio module
- j) **Ajustes de volumen.**/Volume adjustment
- l) **Ajuste de la orientación de la telecámara.** /Camera orientation adjustment.
- m) **Tapa del tarjetero de identificación.** /Identification cardholder cover
- n) **Bornes de conexión de los pulsadores.** /Connection terminals push-button
- o) **Portalámparas y lámparas.** /Lamps and sockets
- p) **Fijación inferior a caja de empotrar.** /Bottom fixing to the mounting box
- q) **Muelle de abatimiento de placa.** /Panel taking down spring
- r) **Conector de los módulos de audio y video.** /Audio and camera module connection
- s) **Conector de columnas.**/Columns connector
- t) **Conector de filas.**/Lines connector
- u) **alimentación de la lampara**/lamp's power supply

Esquema unifilar - Schematic representation

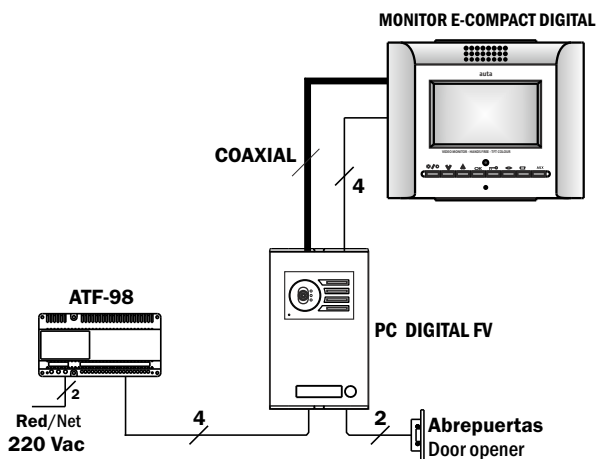

Relación de material- Materials relation

COMPONENTES/ COMPONENTS	NOMBRE/NAME	UNIDADES/ UNITS	REF.
Monitor Monitor	Monitor E-COMPACT digital digital E-COMPACT monitor	1	
Placa de calle Outside panel	PC digital FV	1	
Caja de empotrar mounting box	Caja de empotrar mounting box	1	509022
Módulo de control module of control	Módulo de control module of control	1	600013
Alimentador Power supply	ALV-1.5A	1	715303
Abrepuertas Door opener	Abrepuertas Door opener	*	720001

(1) unidades según instalación. Units depending on installation
 (*) No incluido. Not included

Funcionamiento - Functioning

(Ver hoja informativa adjunta)
 (See HI-200)

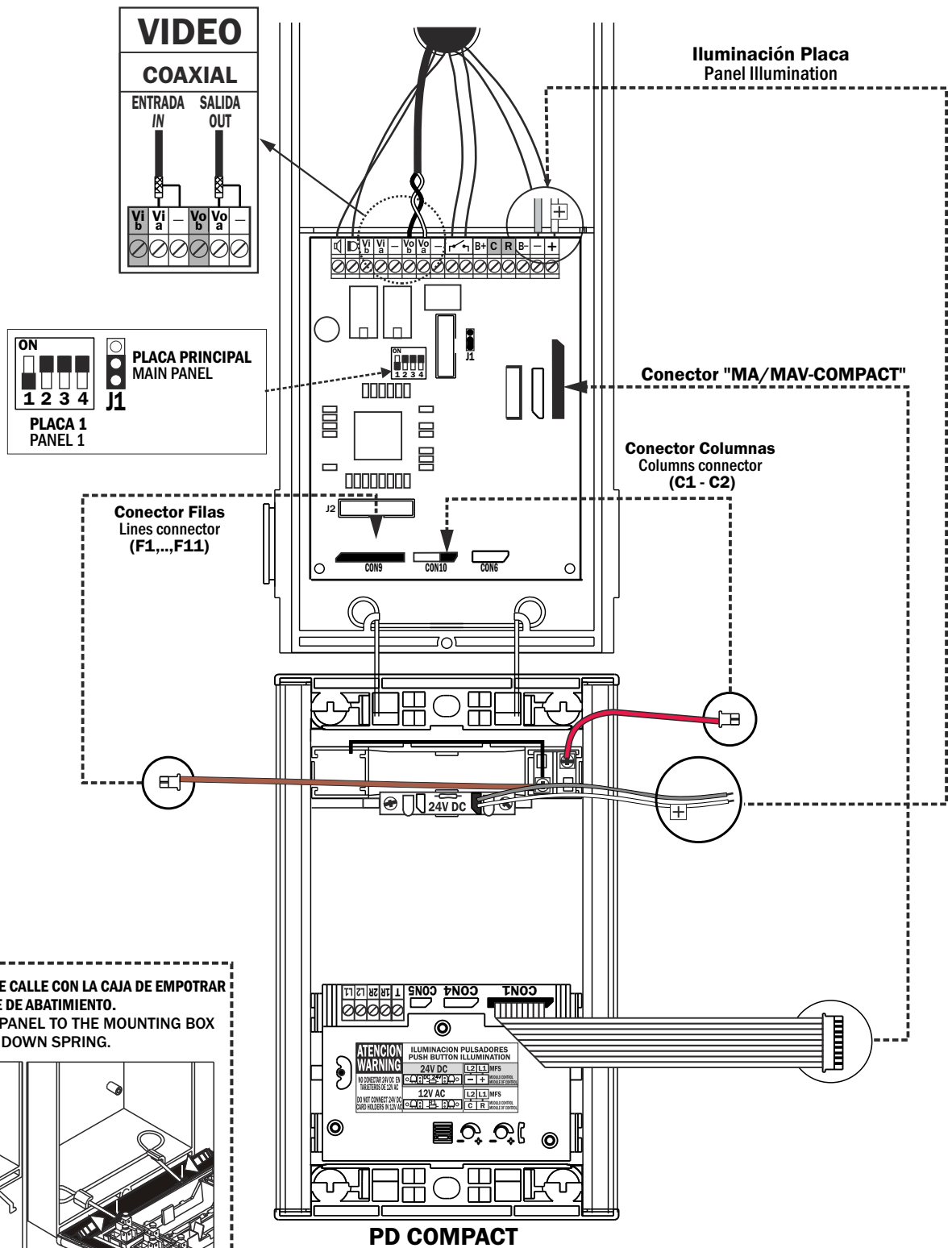

ACOPLAR LA PLACA DE CALLE CON LA CAJA DE EMPOTRAR MEDIANTE EL MUELLE DE ABATIMIENTO. FIT THE EXTERNAL PANEL TO THE MOUNTING BOX USING THE TAKING DOWN SPRING.

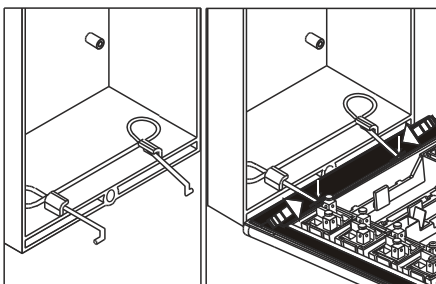

Colocar el muelle de abatimiento de placa que se sirve en la bolsa de accesorios, en la caja de empotrar, y a continuación enganchar la placa de calle presionando el muelle tal y como se indica en la figura.

Fit the panel taking down spring, that's delivered in the accessories bag, in the mounting box. Then join the external panel pressing the spring as showed up in the drawing.

PRINCIPAL

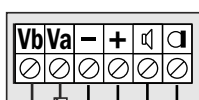

CÓDIGO/ CODE 1

150 75 VALOR CARGA
 S C CON CARGA (FINAL)
 P S MONITOR PRINCIPAL

Secciones de hilos Wiring sections	Hasta 100 m. Up to 100 m.	Hasta 200 m. Up to 200 m.
(+), (-), R, C	1 mm ²	2 mm ²
	0.5 mm ²	1 mm ²
Coaxial	Tipo-Type RG-59 de 75 Ω	

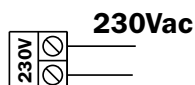
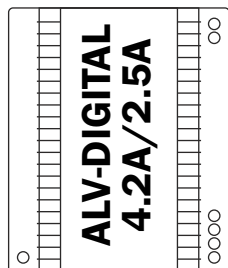

Secciones de hilos Wiring sections	Hasta 100 m. Up to 100 m.	Hasta 200 m. Up to 200 m.
(+), (-), R, C	1 mm ²	2 mm ²
	0.5 mm ²	1 mm ²
Coaxial	Tipo-Type RG-59 de 75 Ω	

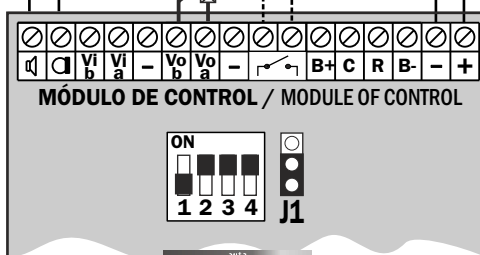
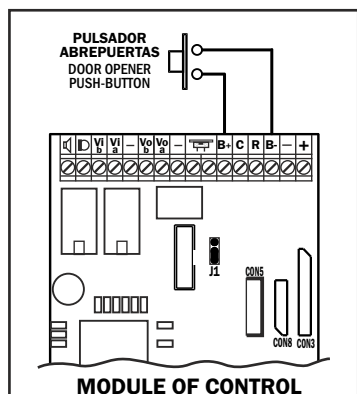

PC DIGITAL FV

