

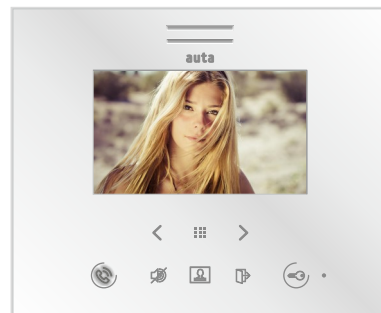

KIT VIDEO DIGITAL S1

KVD-1

SLIM



VISUALTECH

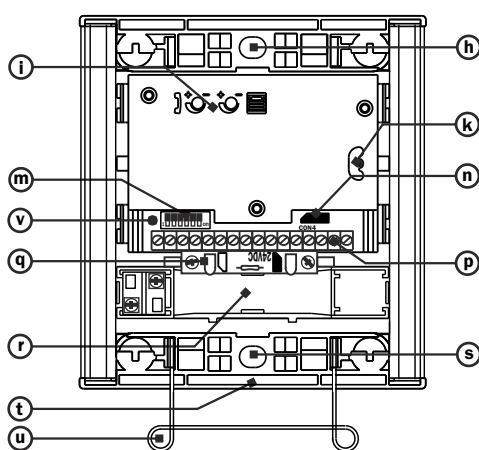
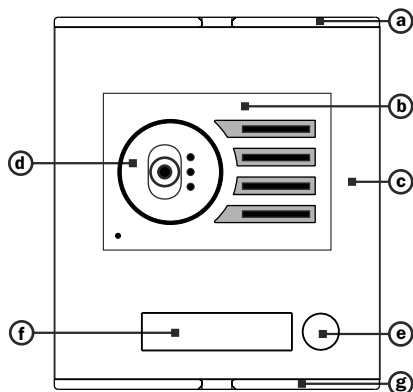

- a) **Cabezal superior.**/Grey top head
- b) **Rejilla del módulo de fonía/video.**/Audio/video module grill
- c) **Placa de aluminio.**/Aluminium extruded
- d) **Telecámara.**/Camera module
- e) **Pulsador de llamada.**/Call push-button
- f) **Tarjetero de identificación.**/Identification cardholder
- g) **Cabezal inferior.** /Grey bottom head
- h) **Fijación superior a caja de empotrar.**/Top fixing to the mounting box
- i) **Ajustes de volumen.**/Volume adjustment
- j) **Módulo de fonía.**/Audio module
- k) **Ajuste de la orientación de la telecámara.** /Camera orientation adjustment.
- m) **Switch de configuración.** /Configuration switch
- n) **Conector pulsador** / Push button connector
- p) **Bornes de conexión** / Terminals connection
- q) **Portalámparas y lámparas.** /Lamps and sockets
- r) **Tapa del tarjetero de identificación.** /Identification cardholder cover
- s) **Fijación inferior a caja de empotrar.** /Bottom fixing to the mounting box
- t) **Cabezal inferior.**/Grey down head
- u) **Muelle de abatimiento de placa.** /Panel taking down spring)
- v) **Ajuste de balance.**/Balance Adjust

Esquema unifilar - Schematic representation

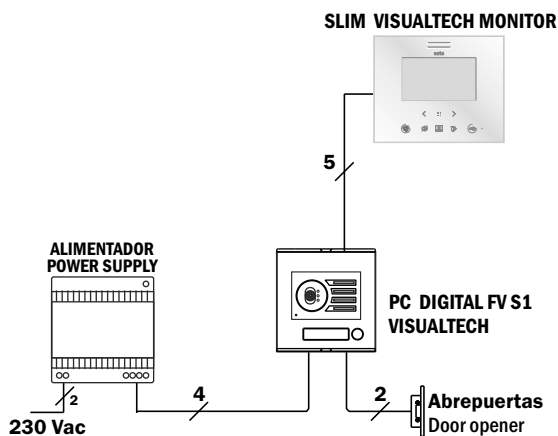

Relación de material- Materials relation

COMPONENTES/ COMPONENTS	NOMBRE/NAME	UNIDADES/ UNITS	REF.
Monitor Monitor	Monitor SLIM VISUALTECH	1	
Placa de calle Outside panel	PC digital FV S1 VISUALTECH	1	
Caja de empotrar mounting box	Caja de empotrar mounting box	1	509022
Alimentador Power supply	ALV 1.5A	1	716003
Abrepuertas Door opener	Abrepuertas Door opener	*	

(1) unidades según instalación. Units depending on installation
 (*) No incluido. Not included

Fonctionnement

(VER/SEE hi-350)

CODIGO DE COLORES PARA CABLE CAT 5
COLOR CODES FOR CAT 5 CABLE

CABLE/WIRE		
VERDE Y BLANCO GREEN AND WHITE	Vb	No usar el par verde con telefonos Do not use the green pair with phone
VERDE GREEN	Va	
NARANJA/BLANCO + NARANJA ORANGE/WHITE+ORANGE	+	
MARRON/BLANCO + MARRON BROWN/WHITE + BROWN	-	
AZUL/BLANCO + AZUL BLUE/WHITE + BLUE	Z	

CAT 5*

* Cable de datos compuesto por 4 pares de hilos trenzados.
Eight-conductor data cable contains 4 pairs of wires.

Sección de hilos Wiring sections	Hasta 100 m. Up to 100 m.
(+), (-), Z	0.22 mm ²
Va, Vb	0.22 mm ²

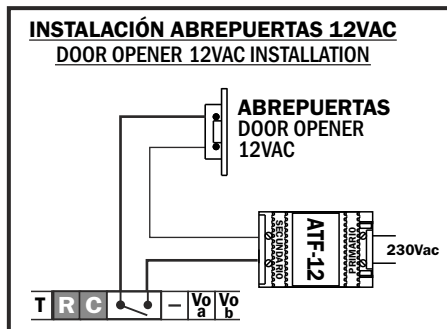
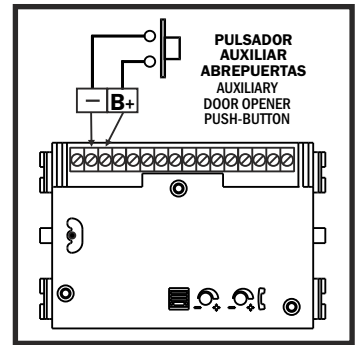
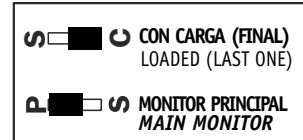
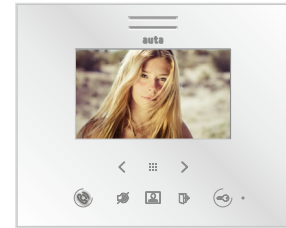
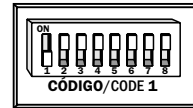
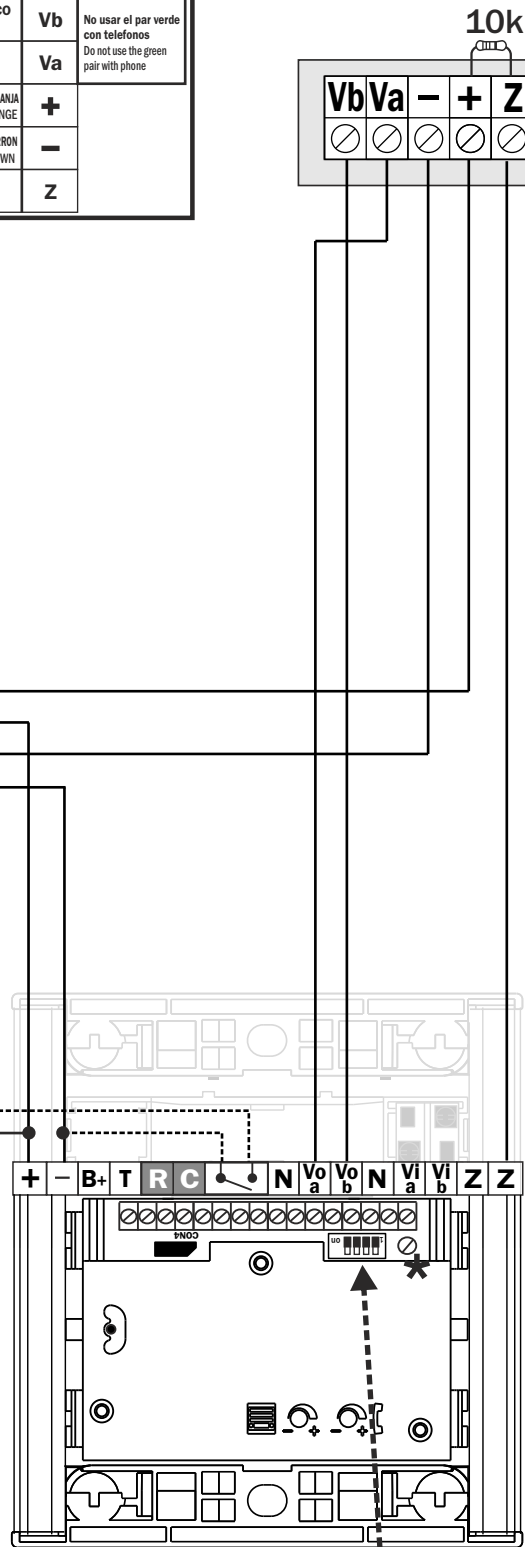
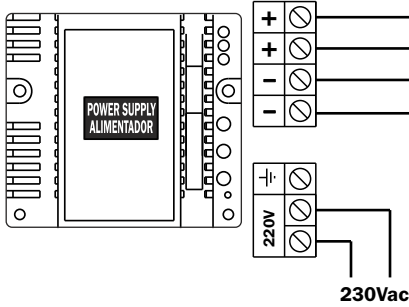

Para evitar entradas de agua a los terminales doblar los cables que van al bloque de fonía como la imagen.

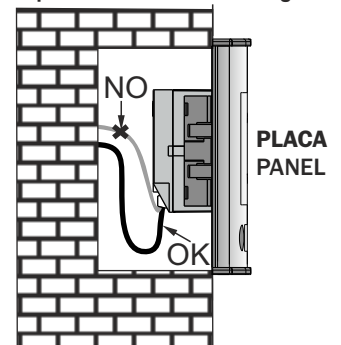

PC DIGITAL FV S1
VISUALTECH

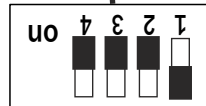

Retocar ligeramente (solo si es necesario) para eliminar acoplamiento.

Retouch slightly (only if it is necessary) to remove coupling.

To prevent from water leakage, fold the cables as show in the picture.

