

auta

LECTOR BIOMÉTRICO BIOMETRIC READER

AUTÓNOMO
STANDALONE



REF. 721163

ESPECIFICACIONES

Capacidad de huellas digitales:	98 plantillas
Producción:	1 relé (2 A/24V CA/CC)
Entrada con botón pulsador:	Sí
Tiempo de apertura de la puerta:	Pulsar (de 1 a 30 segundos) o Conmutar (ENCENDIDO/APAGADO)
Modo de entrada:	Dedo
Programación:	Mediante deslizamiento
Dedos Admin./Instalador:	Dedo de 1 Administrador y 1 Instalador
Retroiluminación ENCENDIDA/APAGADA:	Sí
Timbre ENCENDIDO/APAGADO:	Sí
Actualización de firmware:	a través del convertidor Rs485 y aplicación de Windows
Consumo de corriente:	100 mA máx.
Fuente de alimentación:	9-14 Vcc
Indicación:	Estado LED tricolor
Factor IP:	IP65
Temperatura de almacenamiento/funcionamiento:	de -20 °C a +50 °C
Humedad de almacenamiento/funcionamiento:	HR del 5% al 93% sin condensación
Dimensiones (mm):	92 x 51 x 25

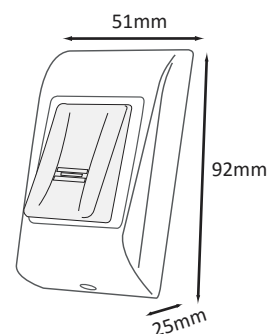

MONTAJE

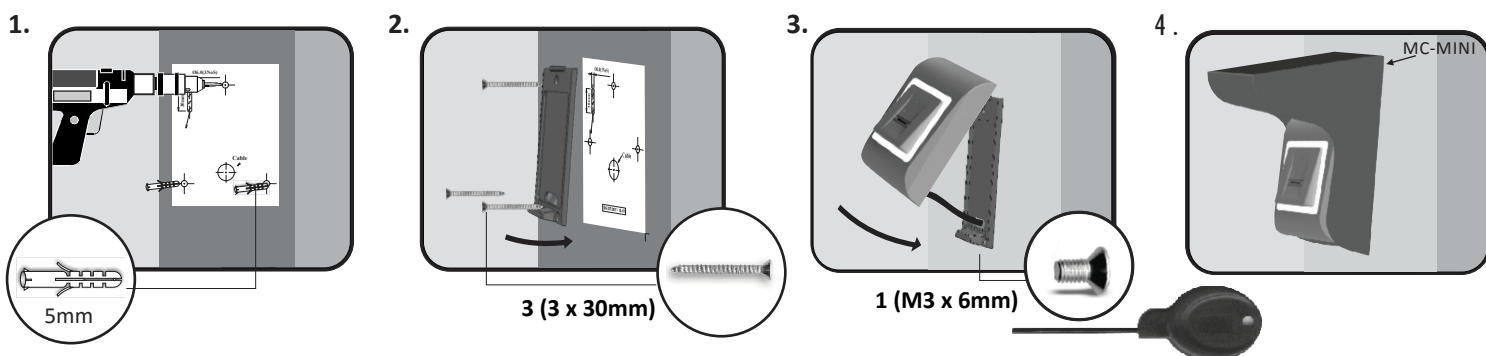

TÉCNICA DE DESLIZAMIENTO RECOMENDADA

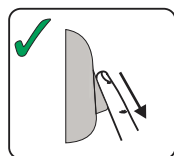

Siga las instrucciones siguientes para realizar un deslizamiento de dedo correcto. A partir de la primera articulación del dedo, se debe colocar el dedo seleccionado en el sensor de deslizamiento y desplazarlo uniformemente hacia uno mismo en un movimiento continuo.

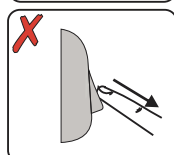

Resultado:

Deslizamiento válido: LED de estado tricolor se muestra de color verde + Pitido de conformidad (pitido corto + largo)

Deslizamiento no válido o leído erróneamente: LED de estado tricolor se muestra de color rojo + Pitido de error (3 pitidos cortos)

INDICACIÓN

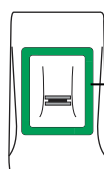

Verde - Acceso concedido

Rojo - Acceso denegado

Naranja - Modo inactivo

Pitido de conformidad - pitido corto + largo

Pitido de error - 3 pitidos cortos

Deslizamiento de dedo - 2 pitidos cortos

CABLEADO

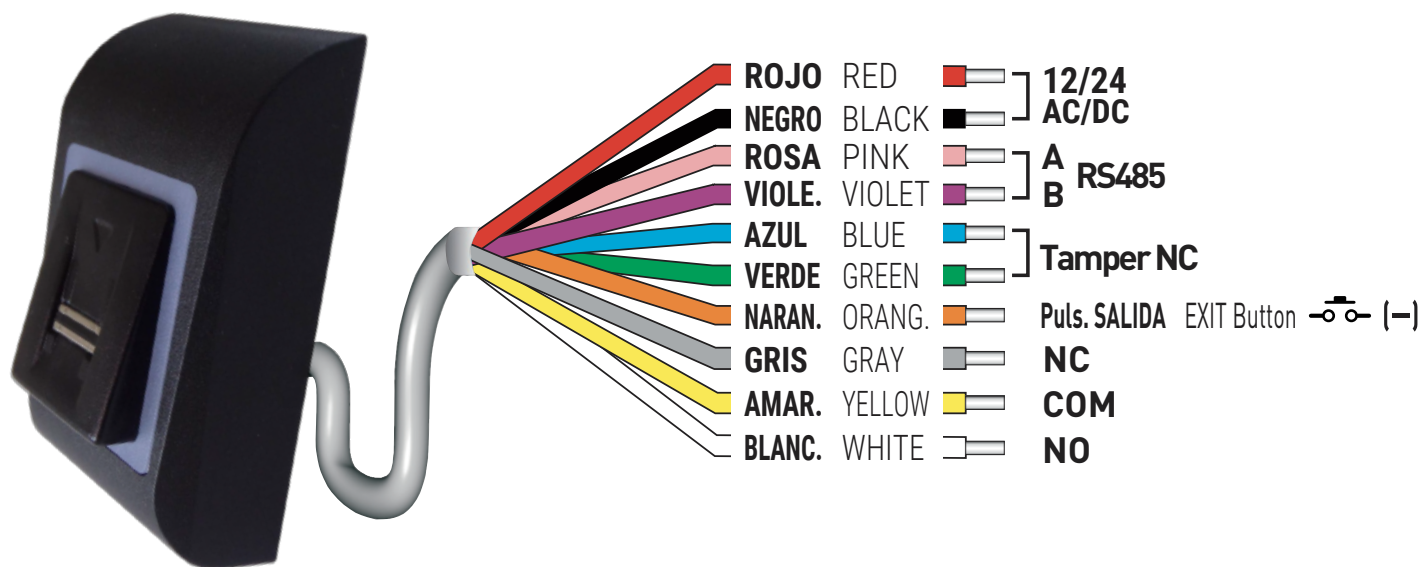

PROGRAMACIÓN DEL ADMINISTRADOR

Utilice los dedos índices como Administrador e Instalador. Puede utilizar el resto de dedos como dedos de acceso. El dedo del administrador se registra al final de la instalación del sistema. El registro inicial del dedo del Administrador se describe en el manual del instalador.

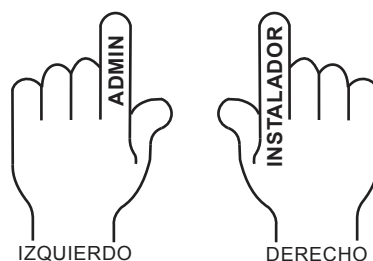

AÑADIR DEDO ADMIN

1. Coloque el interruptor DIP n.º 2 en la posición de ENCENDIDO.



No.2

2. Reinicie la alimentación del dispositivo.



3. Espere a que suenen 1 pitido largo + varios pitidos cortos

4. Coloque el interruptor DIP en la posición de APAGADO. (se detendrán los pitidos cortos)



No.2



5. Espere unos 15 segundos hasta que el LED parpadee en color naranja.







6. Deslice el dedo Maestro 6 veces mín. (Hasta que suene el pitido de conformidad)







x 6

Advertencia: con este procedimiento también se eliminan todos los usuarios y el dedo del instalador.





AÑADIR / CAMBIAR DEDO INSTALADOR

ACCIÓN	DEDO	RETROILUMINACIÓN	SONIDO DE TIMBRE
Deslice el dedo ADMIN 6 veces	 x 6	 parpadeo lento	pitido corto
Espera 5 segundos (hasta un parpadeo rápido)			
Deslice el NUEVO dedo INTALADOR 6 veces mín.	 x 6	 parpadeo rápido	3 pitidos cortos





AÑADIR DEDO USUARIO

ACCIÓN	DEDO	RETROILUMINACIÓN	SONIDO DE TIMBRE
Deslice el dedo ADMIN 1 vez	 x 1	 parpadeo lento	pitido corto
Espera 5 segundos (hasta un parpadeo rápido)			
Deslice el dedo USUARIO 6 veces mín. (hasta un pitido corto + pitido largo)	 x 6	 parpadeo rápido	pitido corto + largo





ELIMINAR DEDO USUARIO

ACCIÓN	DEDO	RETROILUMINACIÓN	SONIDO DE TIMBRE
Deslice el dedo ADMIN 4 veces	 x 4	 parpadeo lento	pitido corto
Espera 5 segundos (hasta un parpadeo rápido)			
Deslice el dedo USUARIO	 x 1	 parpadeo rápido	pitido corto + largo







ELIMINAR TODOS LOS USUARIOS

ACCIÓN	DEDO	RETROILUMINACIÓN	SONIDO DE TIMBRE
Deslice el dedo ADMIN 4 veces	 x 4	 parpadeo lento	pitido corto
Espera 5 segundos (hasta un parpadeo rápido)			
Deslice el dedo ADMIN 2 veces	 x 2	 parpadeo rápido	varios pitidos





CAMBIAR DEDO ADMIN

ACCIÓN	DEDO	RETROILUMINACIÓN	SONIDO DE TIMBRE
Deslice el dedo ADMIN 5 veces	 x 5	 parpadeo lento	pitido corto
Espera 5 segundos (hasta un parpadeo rápido)			
Deslice el NUEVO dedo ADMIN 6 veces mín.	 x 6	 parpadeo rápido	pitido corto + largo





CONFIGURACIÓN DEL TIEMPO DE ACTIVACIÓN RELÉ (DEFECTO 2 SEG.)

ACCIÓN	DEDO	RETROILUMINACIÓN	SONIDO DE TIMBRE
Deslice el dedo ADMIN 1 vez	 x 1	 parpadeo lento	pitido corto
Espera 5 segundos (hasta un parpadeo rápido)			
Deslice el dedo INSTALADOR e inicie el recuento de segundos	 x 1	 parpadeo rápido	pitidos de 1 segundo
Deslice el dedo INSTALADOR para detener o espere 30 segundos para poner el relé en modo de conmutación	 x 1	 parpadeo rápido	pitidos cortos + largo

TIMBRE ENCENDIDO_APAGADO

ACCIÓN	DEDO	RETROILUMINACIÓN	SONIDO DE TIMBRE
Deslice el dedo ADMIN 3 veces	 x 3	 parpadeo lento	pitido corto
Espera 5 segundos (hasta un parpadeo rápido)			
Deslice el dedo INSTALADOR	 x 1	 parpadeo rápido	pitidos cortos + largo

RETROILUMINACIÓN ENCENDIDA_APAGADA

ACCIÓN	DEDO	RETROILUMINACIÓN	SONIDO DE TIMBRE
Deslice el dedo ADMIN 4 veces	 x 4	 parpadeo lento	pitido corto
Espera 5 segundos (hasta un parpadeo rápido)			
Deslice el dedo INSTALADOR	 x 1	 parpadeo rápido	pitidos cortos + largo

SPECIFICATIONS

Fingerprint capacity:	98 templates
Output:	1 relay (2 A/24V CA/CC)
Push Button input:	Yes
Door open time:	Pulse (from 1 to 30 seconds) o Toggle (ON/OFF)
Entry mode:	Finger
Programming:	By swiping
Admin./Installer fingers:	1 Administrator and 1 Installer finger
Blacklight ON/OFF:	Yes
Buzzer ON/OFF:	Yes
Firmware upgrade:	Via RS485 converter and windows application
Current consumption:	100 mA máx.
Power supply:	9-14 Vdc
Indication:	Tricolor status led
IP factor:	IP65
Storage/Operating temperature:	from -20 °C to +50 °C
Storage/Operating humidity:	5% to 93% RH without condensation
Dimensions (mm):	92 x 51 x 25

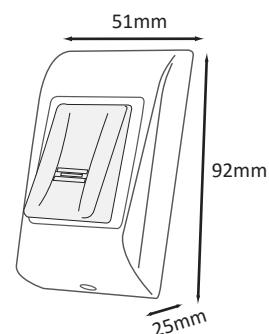

MOUNTING

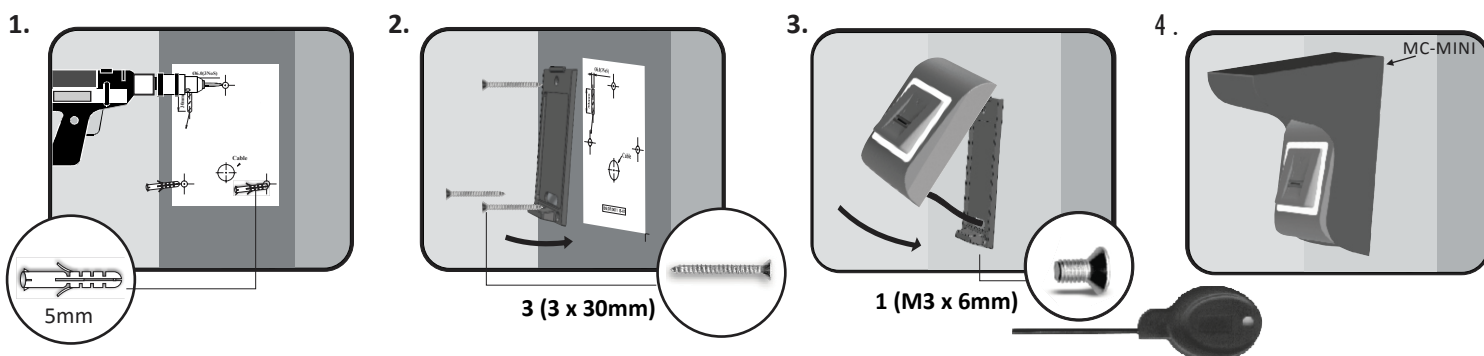

RECOMMENDED SWIPING TECHNIQUE

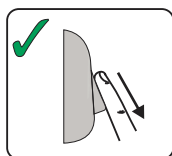

Follow the below instructions for correct finger swiping. Starting from the first finger joint, place the selected finger on the swipe sensor and move it evenly towards oneself in one steady movement.

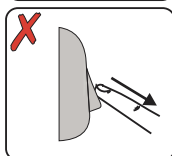

Result:

For a valid swipe: Tricolour Status LED turns green + OK Beep (short + long beep)

For an invalid or misread swipe: Tricolour Status LED turns red + Error Beep (3 short beeps)

INDICATION

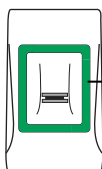

Green - Access granted

Red - Acceso denied

Orange - Idle mode

OK beep - short + long beep

ERROR beep - 3 short beeps

Swipe finger - 2 short beeps

WIRING

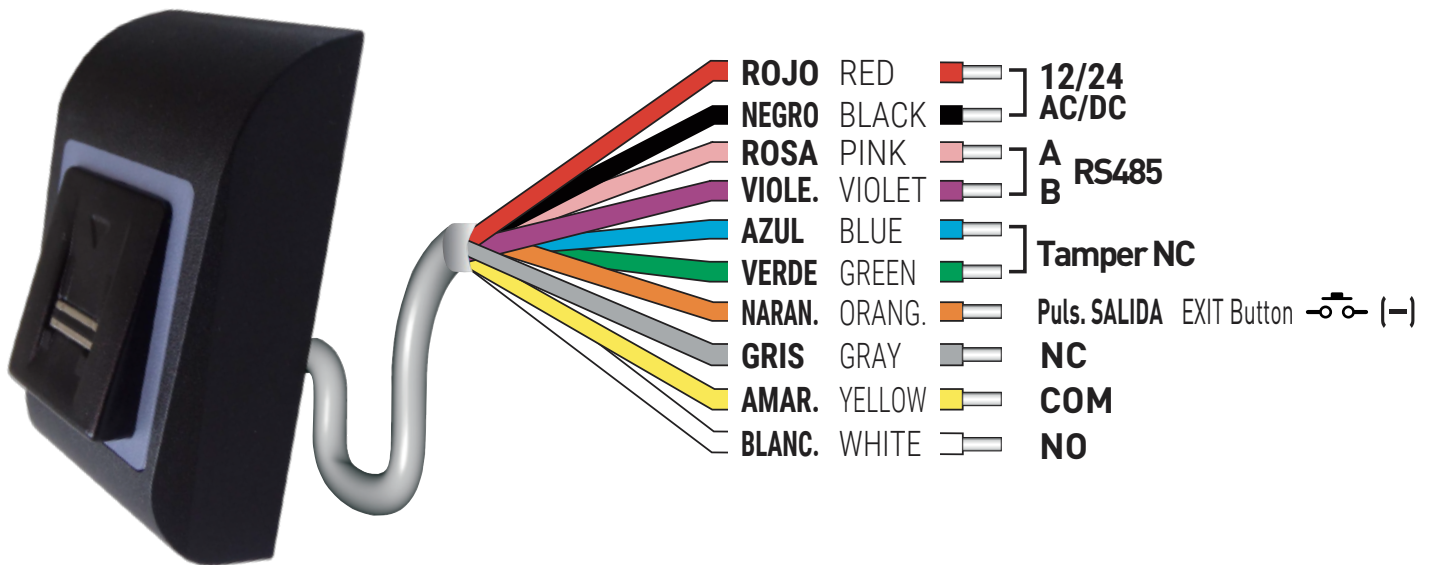

ADMINISTRATOR PROGRAMMING

Use point fingers as Administrator and Installer. You can use the other fingers as access fingers. Administrator finger is enrolled at the end of the system installation. Initial enrollment of the Admin finger is described in installer manual.

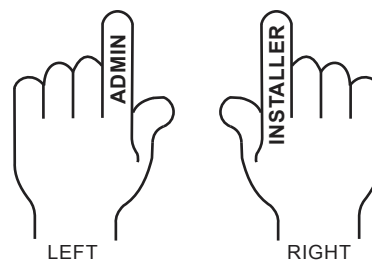





ADDING ADMIN FINGER

1. Set the DIPSWITCH n.º 2 in position ON.
2. Reset the power of the device.
3. Wait for 1 long + multiple short beeps.
4. Set the DIPSWITCH n.º 2 in position OFF. (short beeps will stop)
5. Wait for about 15 seconds for the LED to blink in ORANGE
6. Swipe the MASTER finger min. 6 times. (until OK beep)







Warning: with this procedure also deletes all users and installer finger .





ADD / CHANGE INSTALLER FINGER

ACTION	FINGER	BACKLIGHT	BUZZER SOUND
Swipe ADMIN finger 6 times	 x 6	 slow blinking	short beep
Wait 5 seconds (until fast blinking)			
Swipe the NEW INSTALLER finger 6 times mín.	 x 6	 fast blinking	3 short beeps





ADD USER FINGER

ACTION	FINGER	BACKLIGHT	BUZZER SOUND
Swipe ADMIN finger 1 time	 x 1	 slow blinking	short beep
Wait 5 seconds (until fast blinking)			
Swipe USER finger 6 times mín. (until 1 short + 1 long beep)	 x 6	 fast blinking	short + long beep





DELETE USER FINGER

ACTION	FINGER	BACKLIGHT	BUZZER SOUND
Swipe ADMIN finger 4 times	 x 4	 slow blinking	short beep
Wait 5 seconds (until fast blinking)			
Swipe USER finger	 x 1	 fast blinking	short + long beep







DELETE ALL USERS

ACTION	FINGER	BACKLIGHT	BUZZER SOUND
Swipe ADMIN finger 4 times	 x 4	 slow blinking	short beep
Wait 5 seconds (until fast blinking)			
Swipe ADMIN finger 2 times	 x 2	 fast blinking	multiple beeps





CHANGE ADMIN FINGER

ACTION	FINGER	BACKLIGHT	BUZZER SOUND
Swipe ADMIN finger 5 times	 x 5	 slow blinking	short beep
Wait 5 seconds (until fast blinking)			
Swipe NEW ADMIN finger 6 times mín.	 x 6	 fast blinking	short + long beep





SET RELAY ACTIVATION TIME (DEFAULT 2 SEC.)

ACTION	FINGER	BACKLIGHT	BUZZER SOUND
Swipe ADMIN finger 1 time	 x 1	 slow blinking	short beep
Wait 5 seconds (until fast blinking)			
Swipe INSTALLER finger and start counting seconds	 x 1	 fast blinking	beeps of 1 second each
Swipe INSTALLER finger to stop or wait 30 seconds to set the relay in toggle mode	 x 1	 fast blinking	short + long beep

BUZZER ON_OFF

ACTION	FINGER	BACKLIGHT	BUZZER SOUND
Swipe ADMIN finger 3 times	 x 3	 slow blinking	short beep
Wait 5 seconds (until fast blinking)			
Swipe INSTALLER finger	 x 1	 fast blinking	short + long beep

BACKLIGHT ON_OFF

ACTION	FINGER	BACKLIGHT	BUZZER SOUND
Swipe ADMIN finger 4 times	 x 4	 slow blinking	short beep
Wait 5 seconds (until fast blinking)			
Swipe INSTALADOR finger	 x 1	 fast blinking	short + long beep



Auta Comunicaciones
Pol. Ind. El Oliveral C/ C S/N
46394 Riba-Roja (Valencia)
Tel. 96 164 30 30
Fax. 96 166 52 86
email. auta@auta.es
www.auta.es