

The logo for 'auta' consists of a dark blue square with the word 'auta' written in white lowercase letters in the center.

auta

**COMUNICADO DE PRODUCTO
(ADAPTACIÓN CA-CC)**

PRODUCT NEWS
(AC-DC ADAPTING)

EJEMPLOS DE INSTALACIÓN | EXAMPLES OF INSTALLATION

Gestión de abrepuertas | Door Opener management

Abrepuertas 12Vca 12Vac door opener	2
Conexión directa de abrepuertas 12-24Vcc Direct connection of 12-24Vdc door opener	2
Abrepuertas NO HABITUAL NON USUALLY USED door opener.....	3
Abrepuertas INVERTIDO INVERTED door opener	3
Maniobra con puerta automática Automatic door management	3

SUSTITUCIÓN DE ELEMENTOS | ELEMENTS REPLACEMENT

Placa S1 | Panel S1

Sustitución del grupo fónico A/V module replacement	4
Sustitución de la plancha de pulsadores Pushbutton frame replacement	5

MULTI-VIVIENDA | MULTI-FLAT

Sustitución del módulo de control Module of control replacement	6
Sustitución del módulo de A/V A/V module replacement	7
Sustitución de la placa de pulsadores Pushbutton frame replacement	8
Sustitución del módulo de control y del módulo de A/V	9
Module of control and module of A/V replacement	
Sustitución de la placa de pulsadores y del módulo de A/V	10
Pushbutton frame and module of A/V replacement	
Sustitución del módulo de control y de la placa de pulsadores	11
Module of control and pushbutton frame replacement	

IDENTIFICACIÓN DE NUEVOS ELEMENTOS | NEW ELEMENTS IDENTIFICATION

Elementos antiguos y nuevos | Old and new elements

Iluminación en placa de pulsadores Pushbutton frame illumination	
Módulo A/V S1 Module S1 A/V	
Módulo A/V Multi-Vivienda Module A/V Multi-Flat	
Módulo de control Module of control	

Auta, en su afán por mejorar y evolucionar sus sistemas, ha actualizado la gestión de apertura en toda su gama de producto digital. Esto ofrece una versatilidad total en las instalaciones sin importar el sistema de apertura del que dispongan.

Gracias a esta evolución el uso de tensión alterna (R y C) en el cableado del sistema digital será voluntario. Pudiendo omitirse si el instalador lo considera oportuno.

La actualización de dicho sistema no afecta a las instalaciones realizadas con anterioridad, es posible instalar elementos actuales en instalaciones ya existentes simplemente re-conectando el cableado.

Auta, in its effort to improve and evolve their systems, has updated the management opening system in its range of digital products. This offers total versatility and facilities regardless the existing opening system.

Thanks to this development use AC voltage (R and C) in the wiring of the digital system is voluntary. The installer may be omitted if deemed appropriate.

The update of this system does not affect the installed systems, you can install current elements at existing installations simply re-connecting the wires.

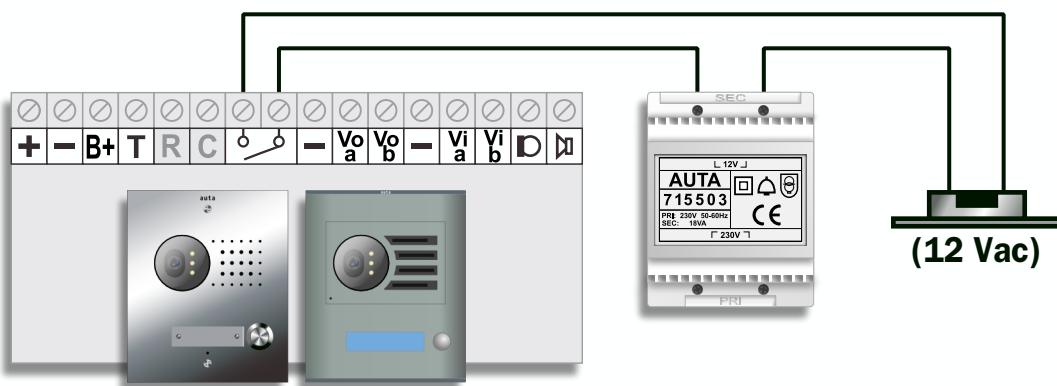

Gestión de un abrepuertas de 12 Vca
Management of 12Vac door opener

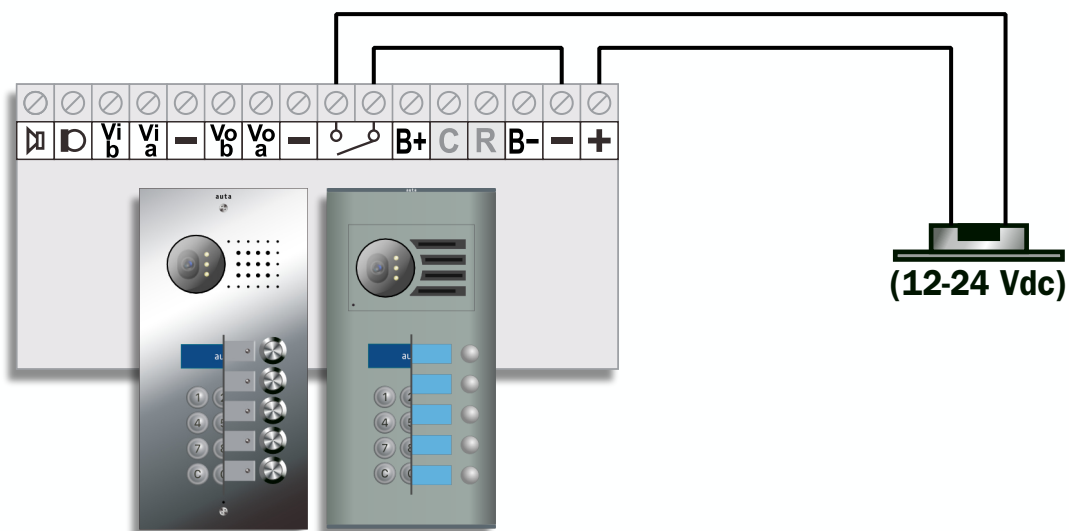

Gestión directa de un abrepuertas de 12-24 Vdc
Direct management of 12-24Vdc door opener

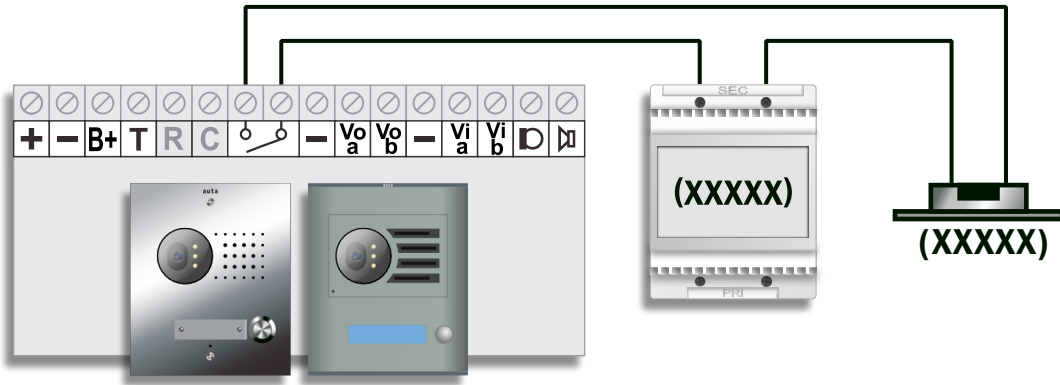

Gestión de un abrepuertas NO HABITUAL (CONSUMO o TENSIÓN)
Management of NON USUALLY USED door opener (CONSUMPTION or TENSION)

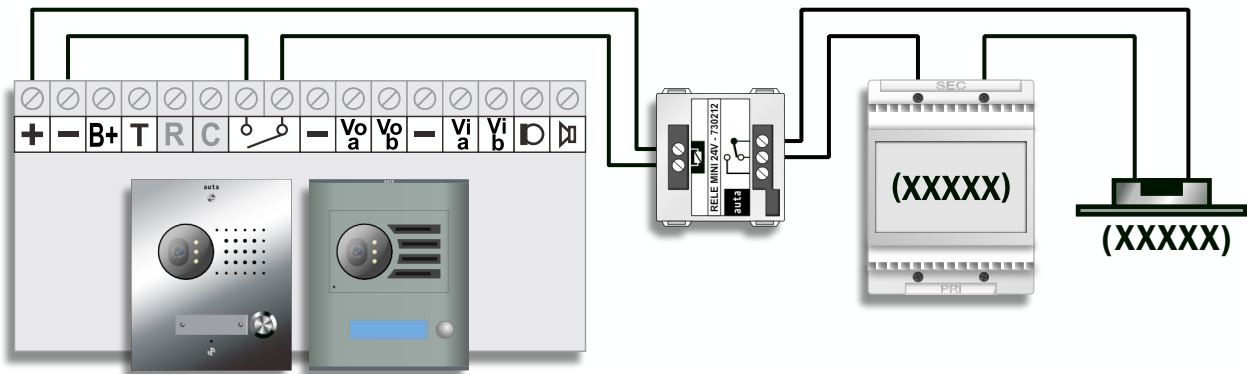

Gestión de un abrepuertas INVERTIDO
Management of INVERTED door opener

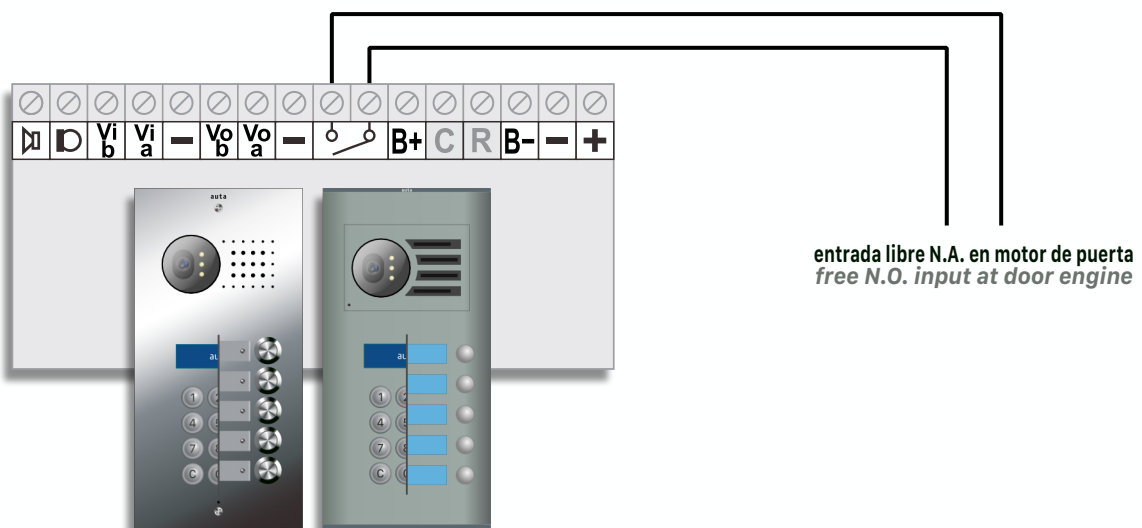

Maniobra de una puerta automática
Automatic door management

PLACA S1

PANEL S1

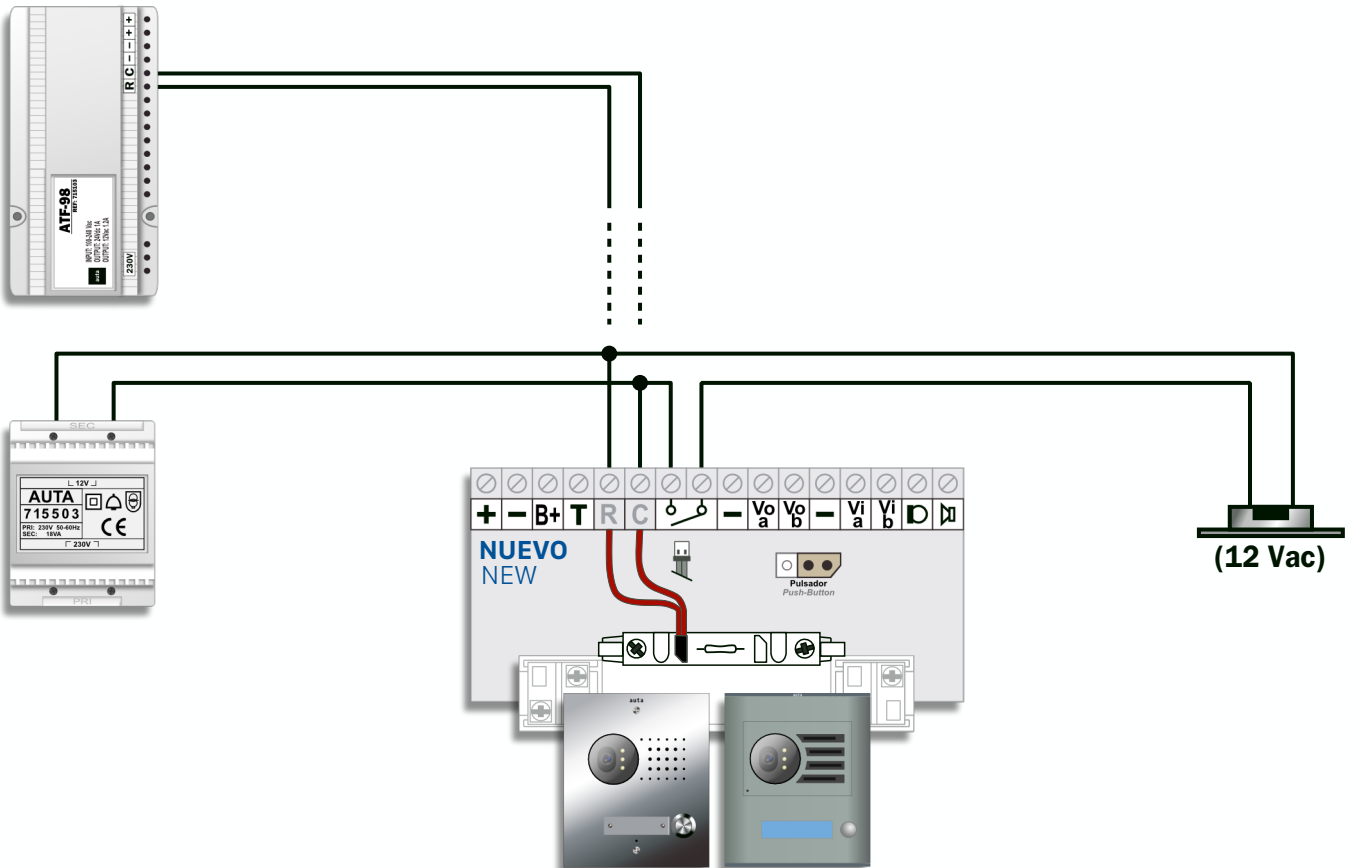
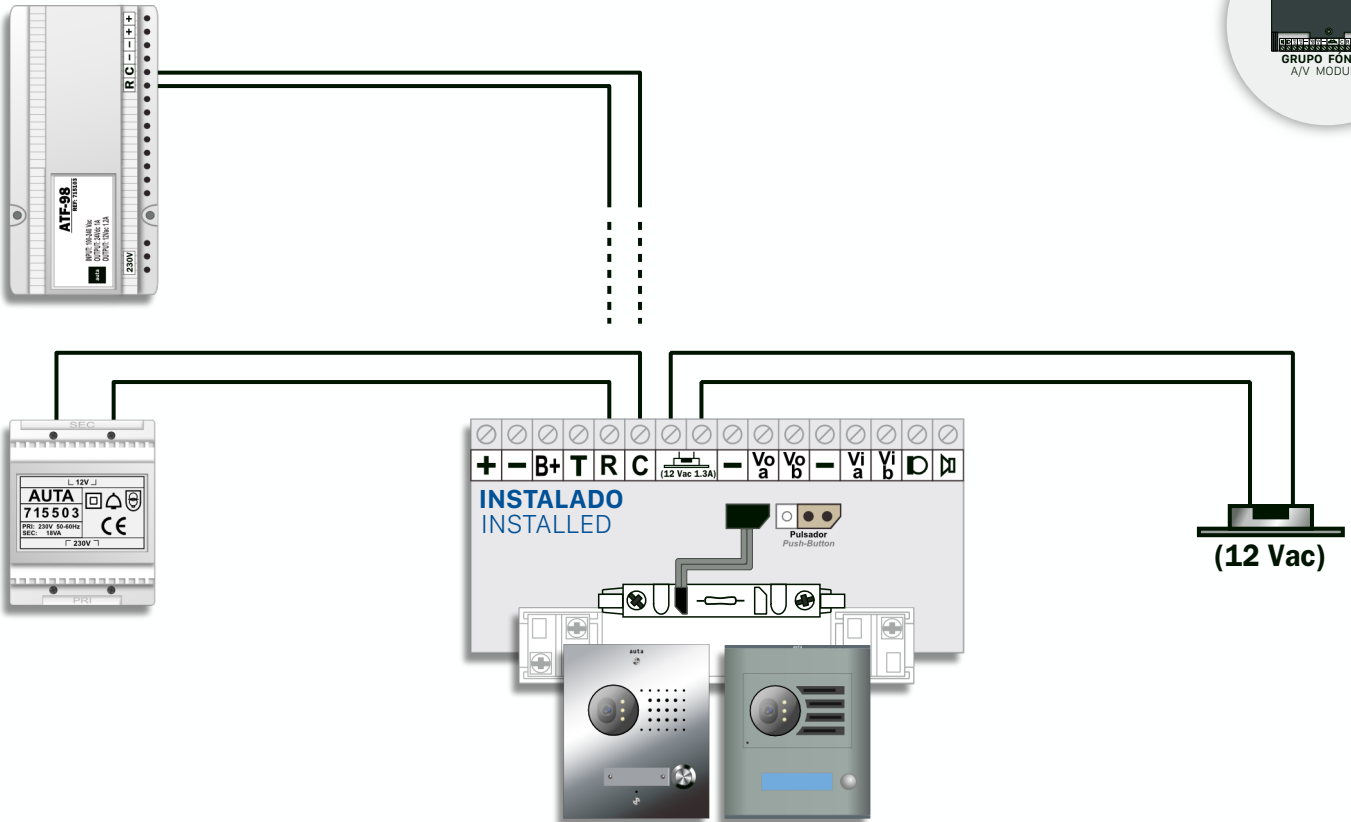
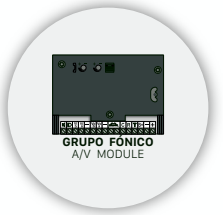

PLACA S1

PANEL S1

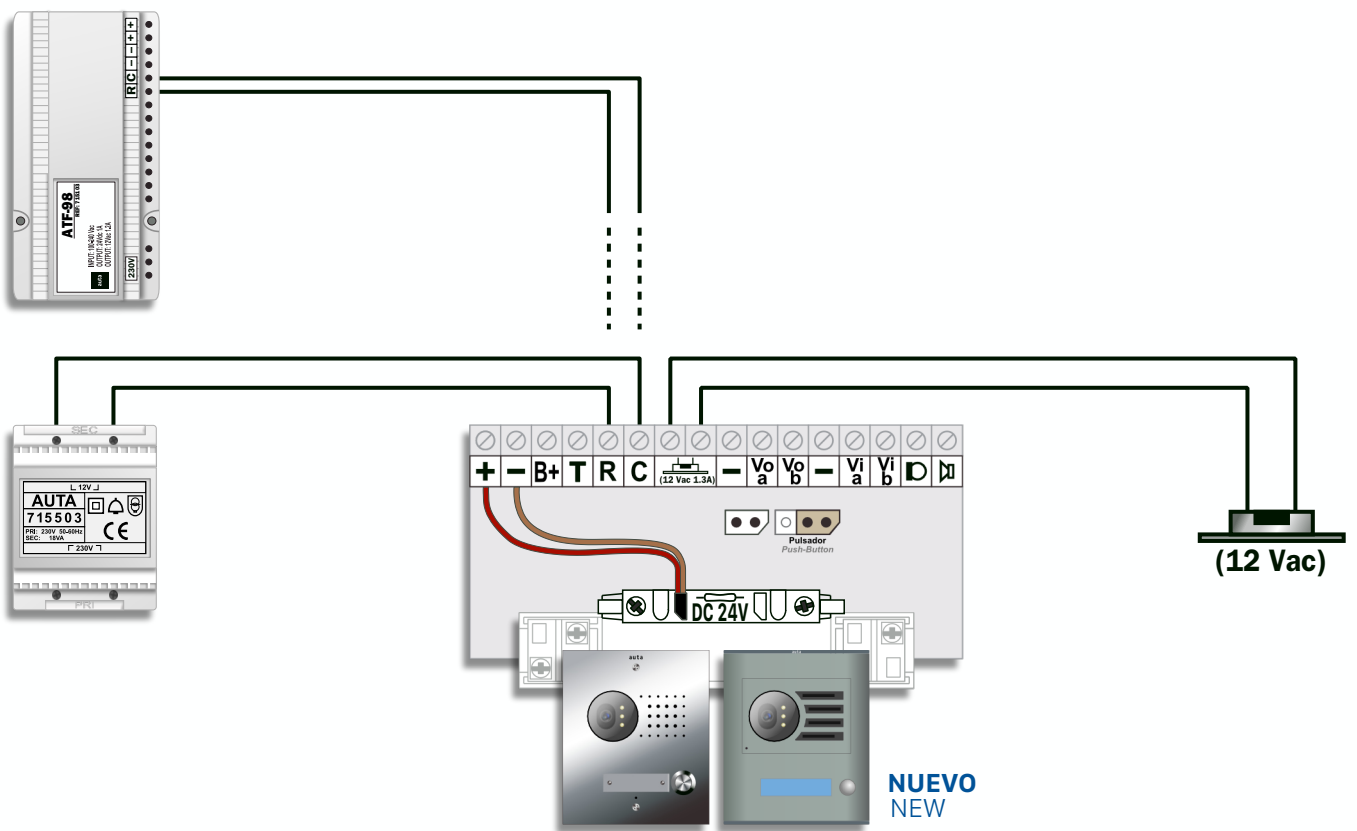
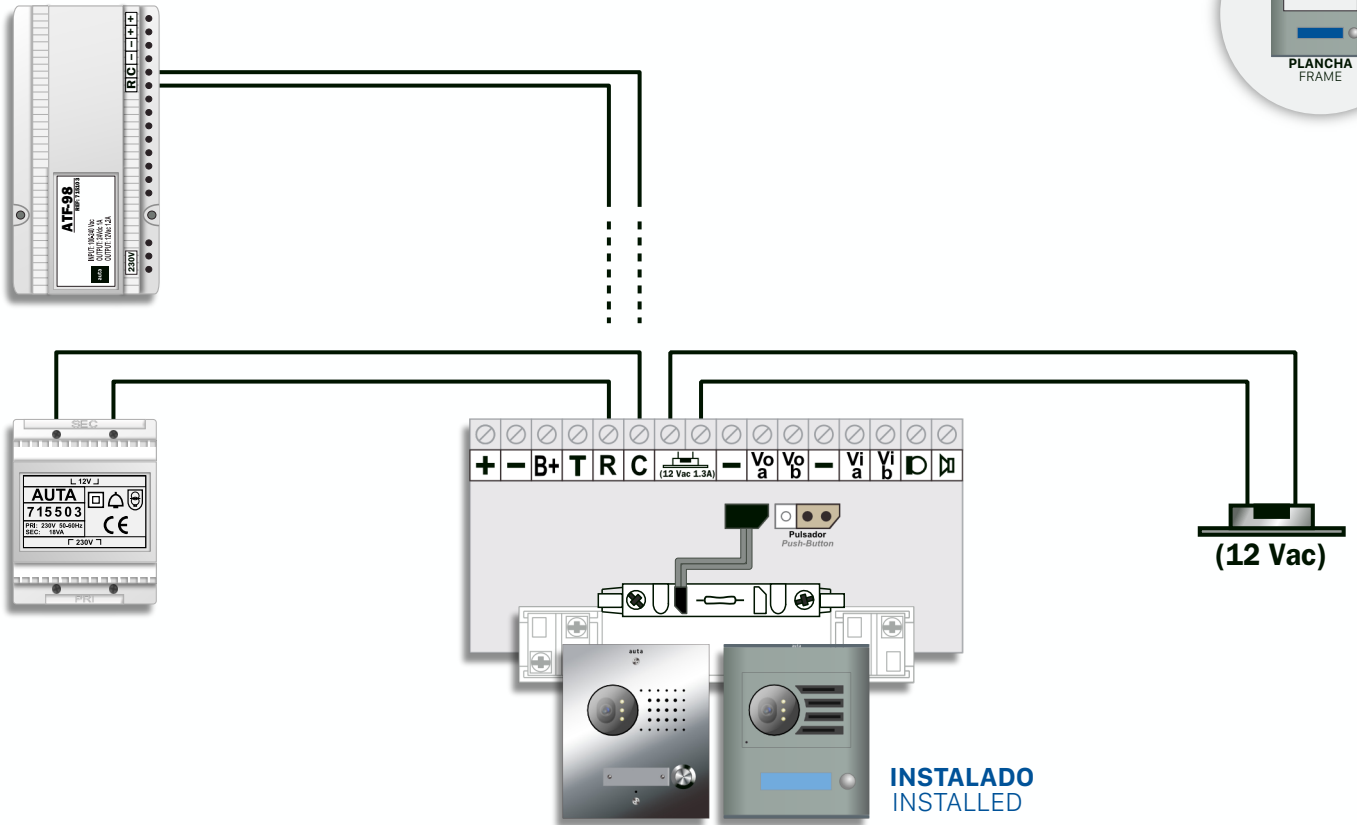
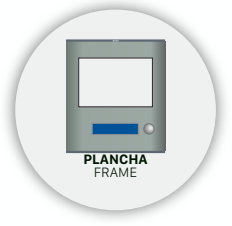

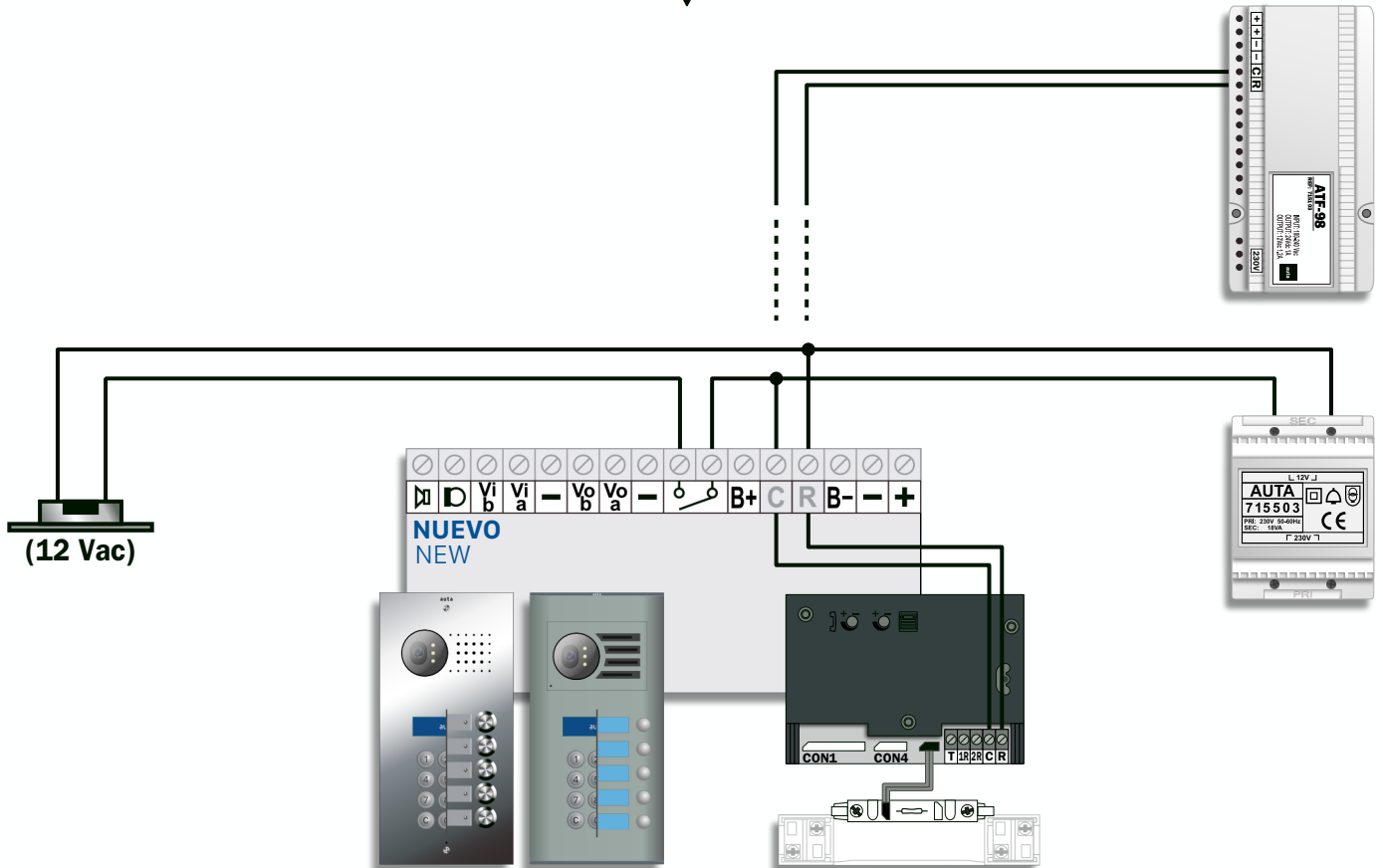
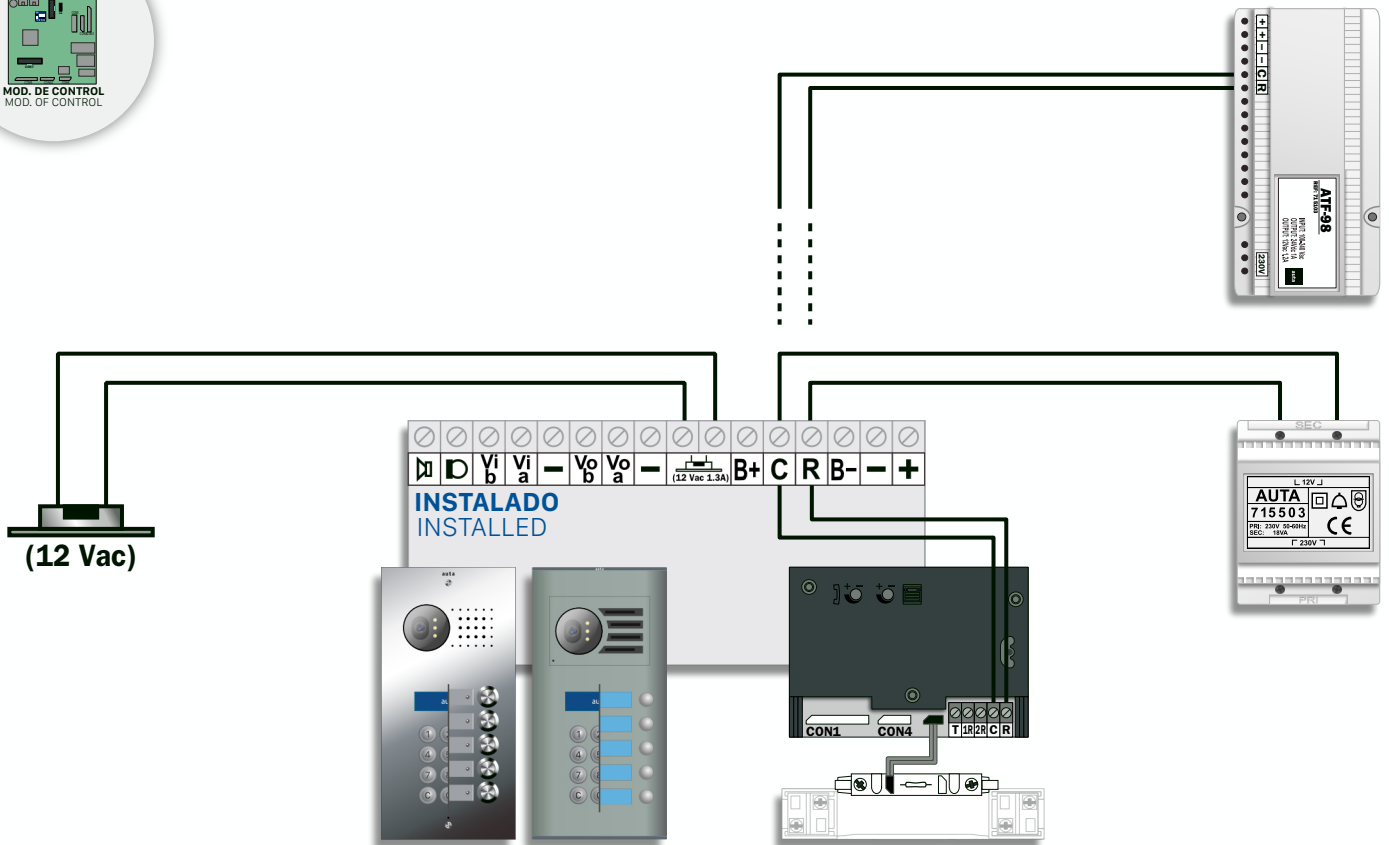
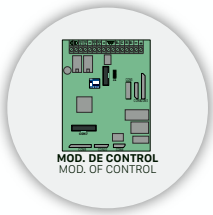

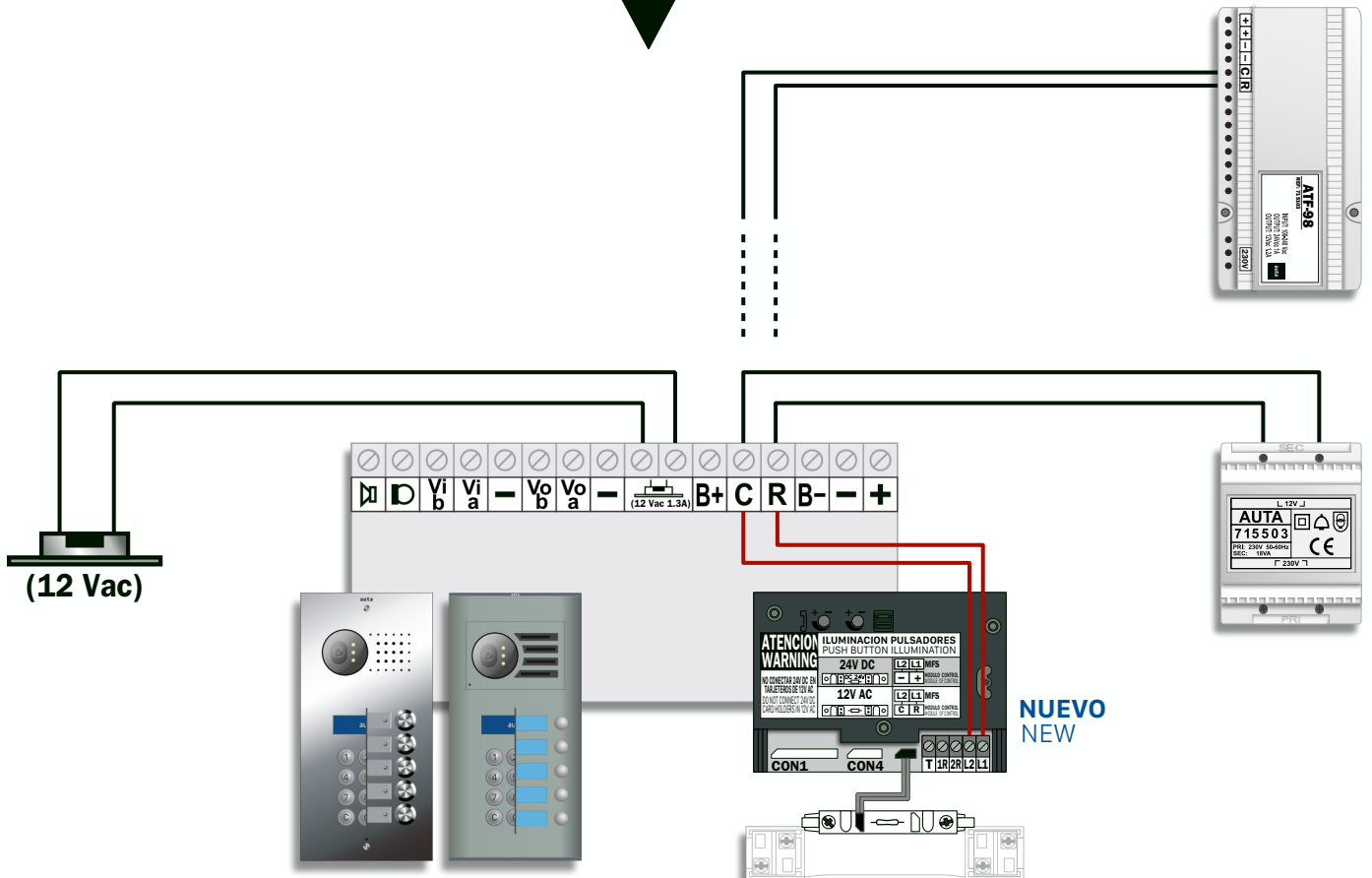
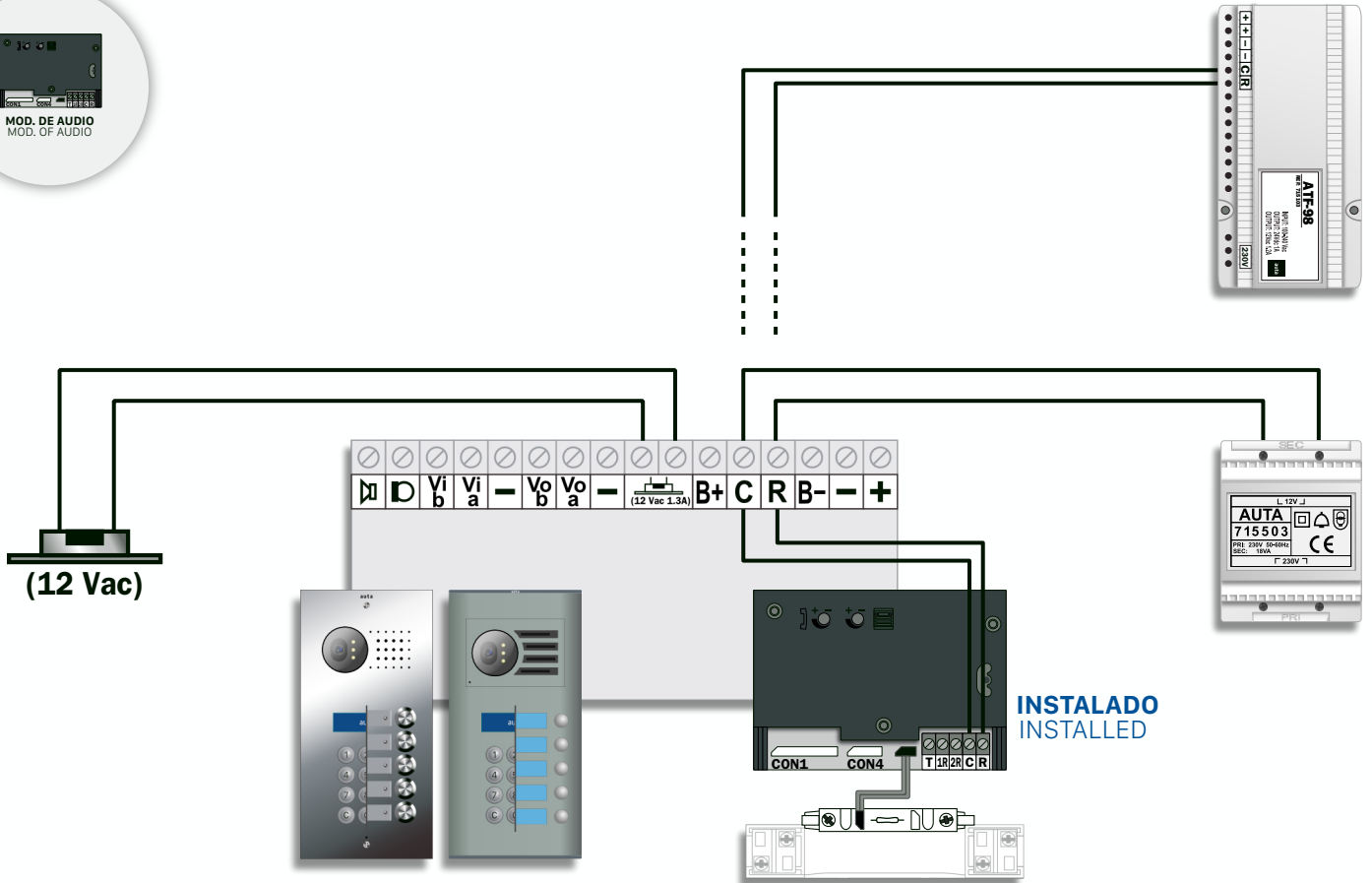

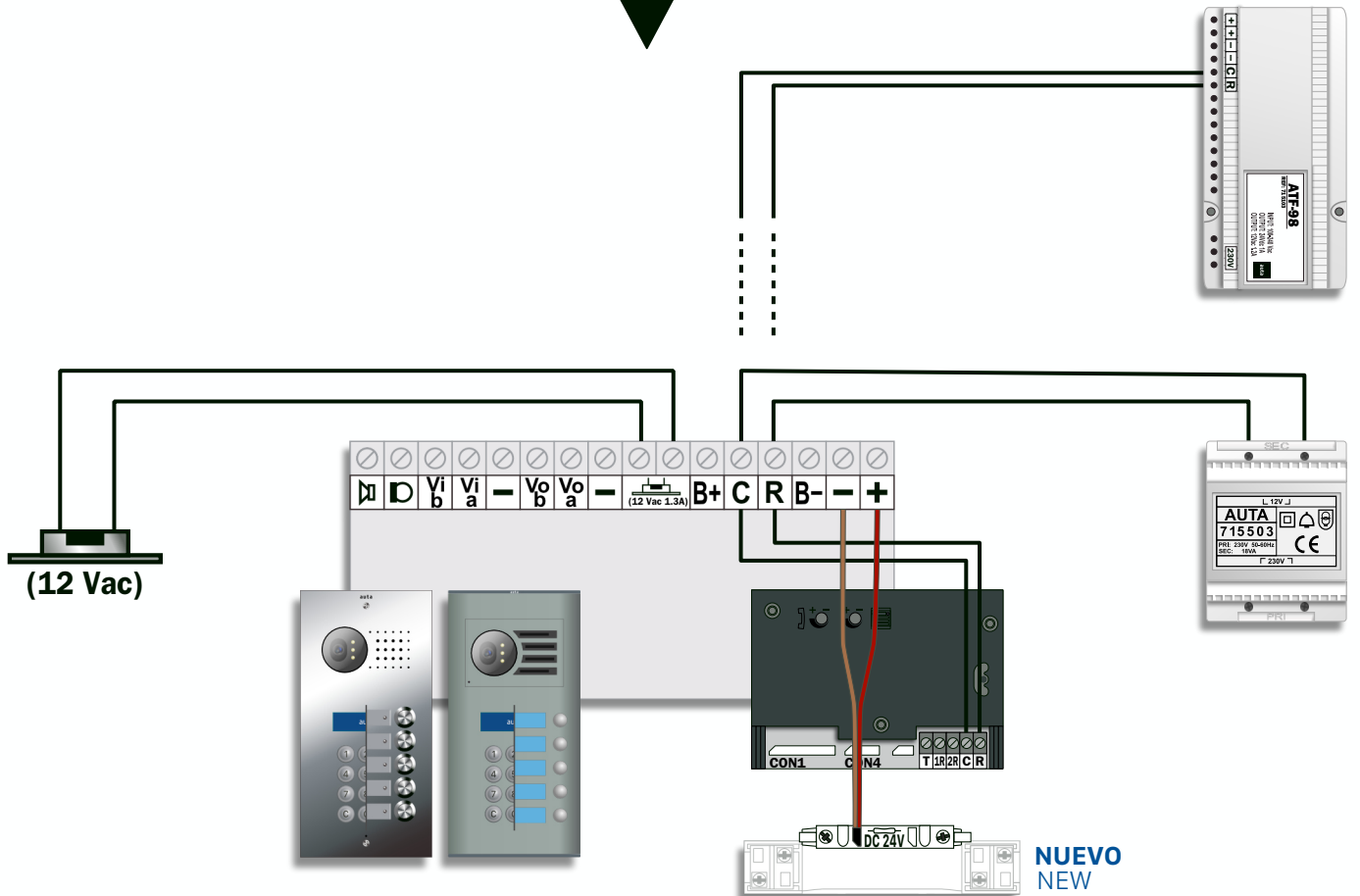
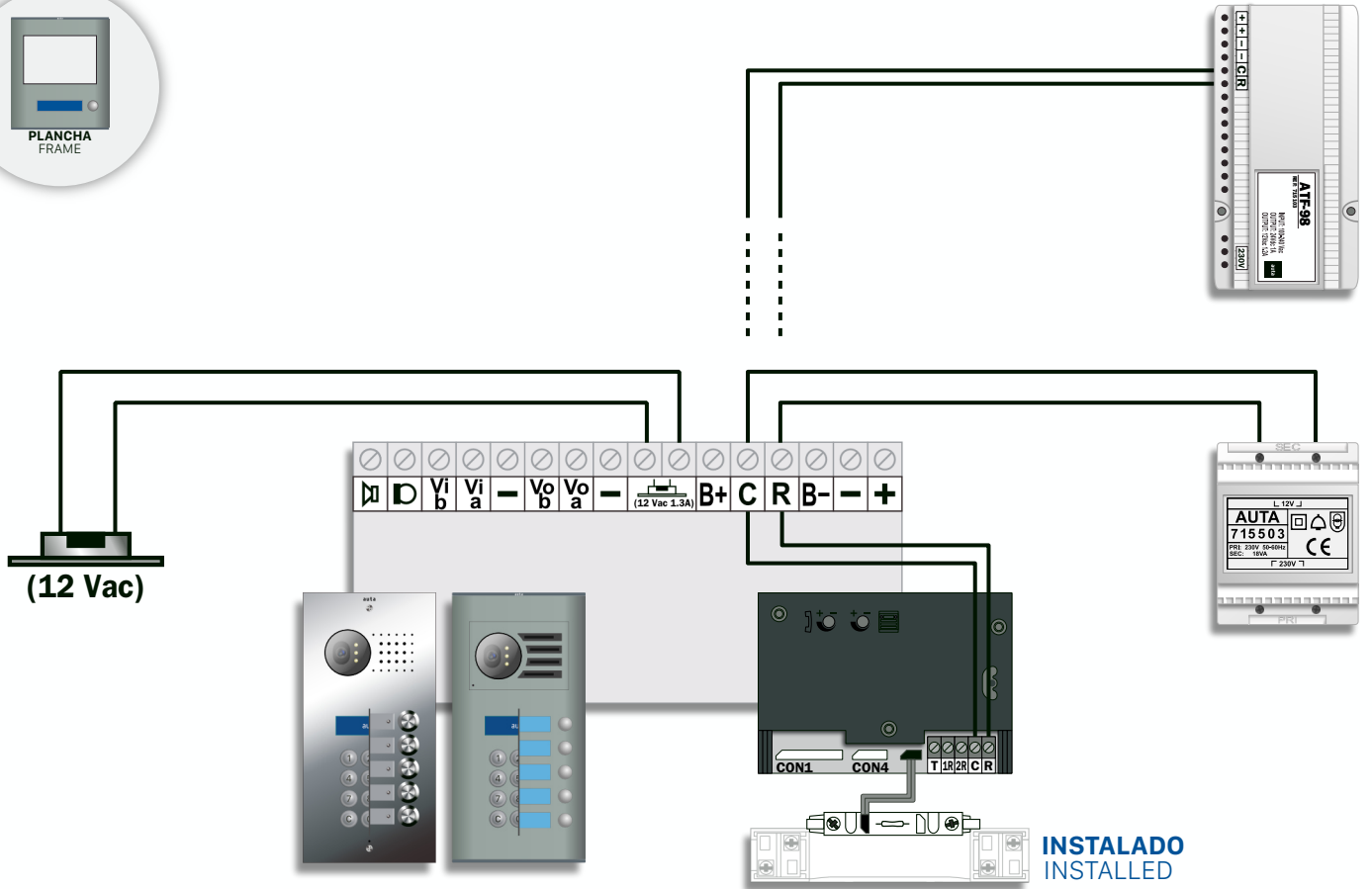
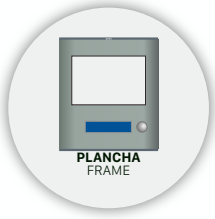

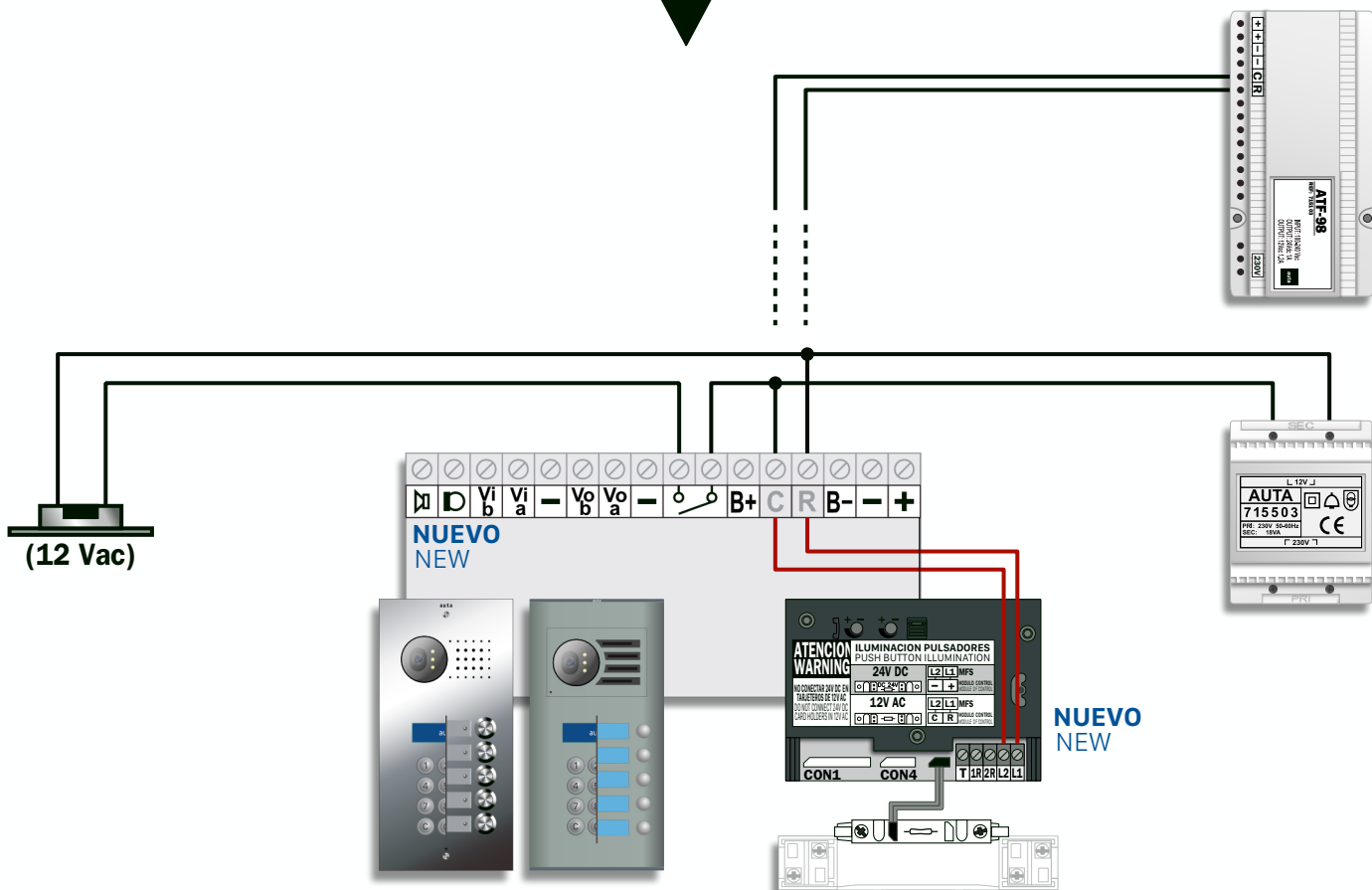
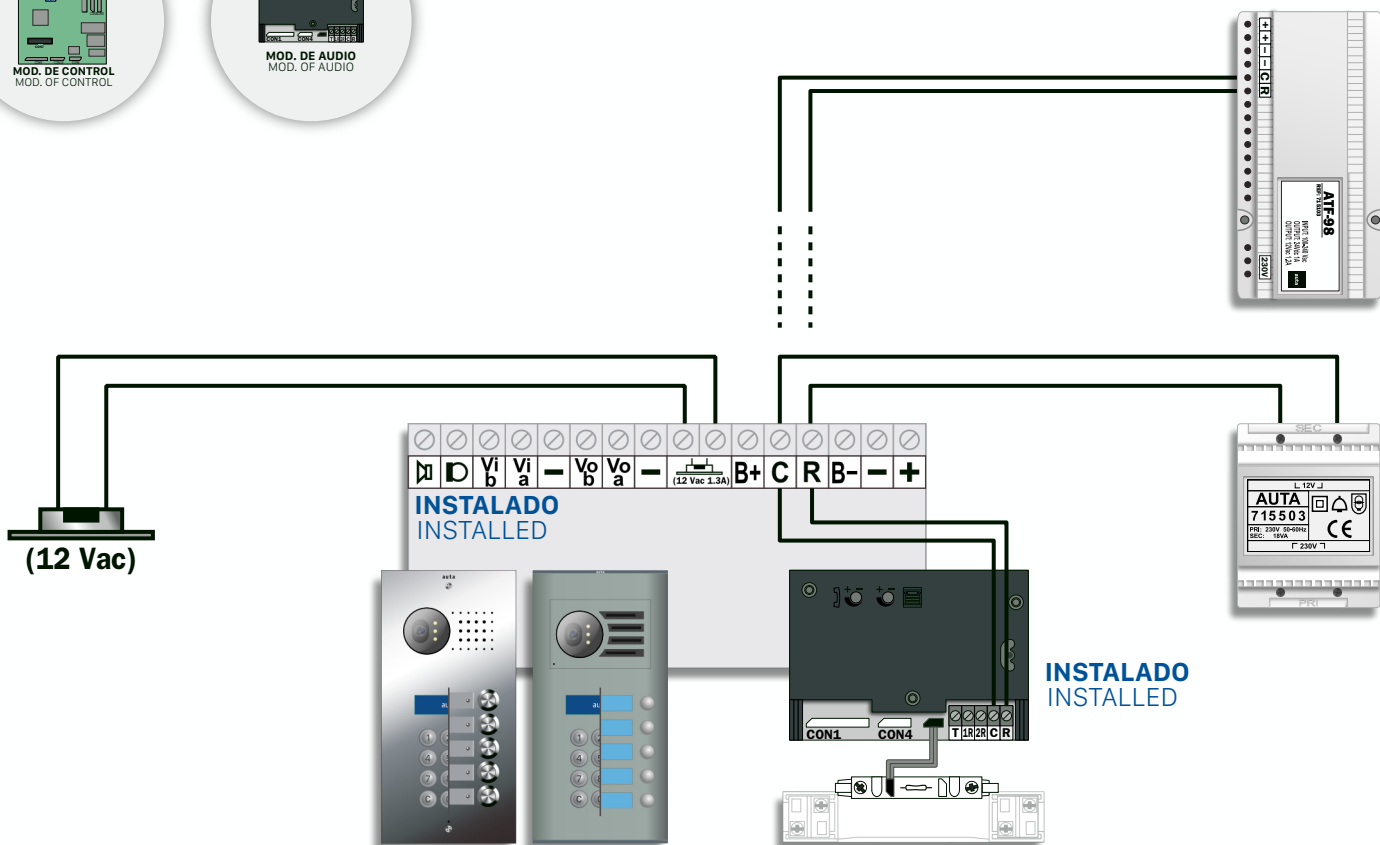
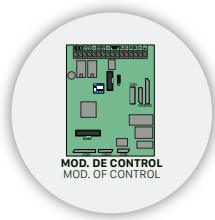

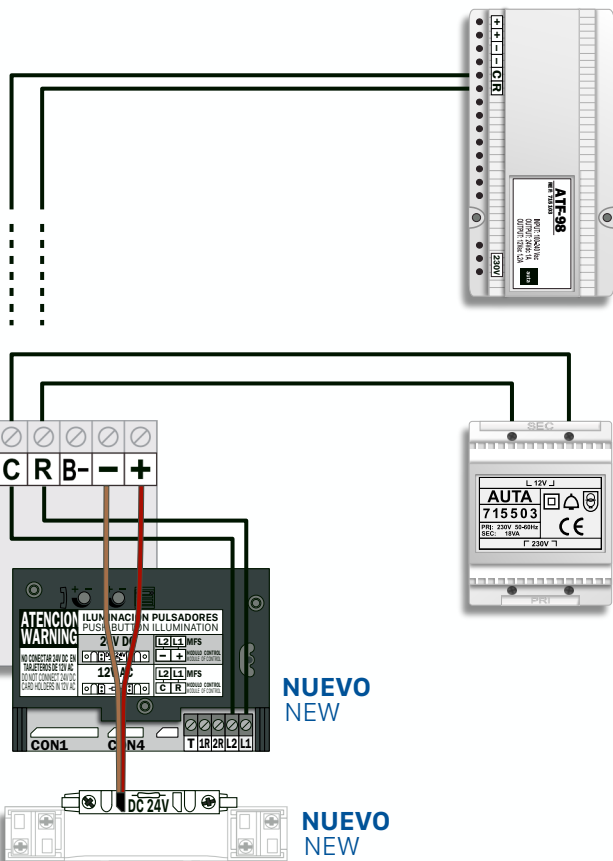
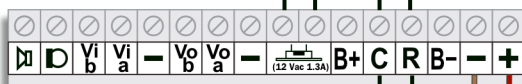
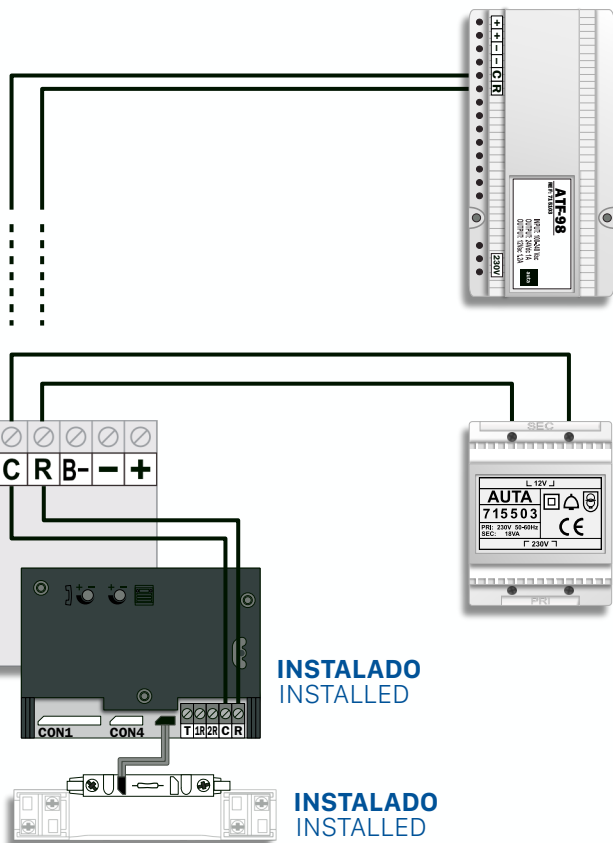
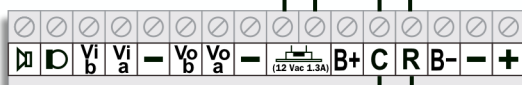

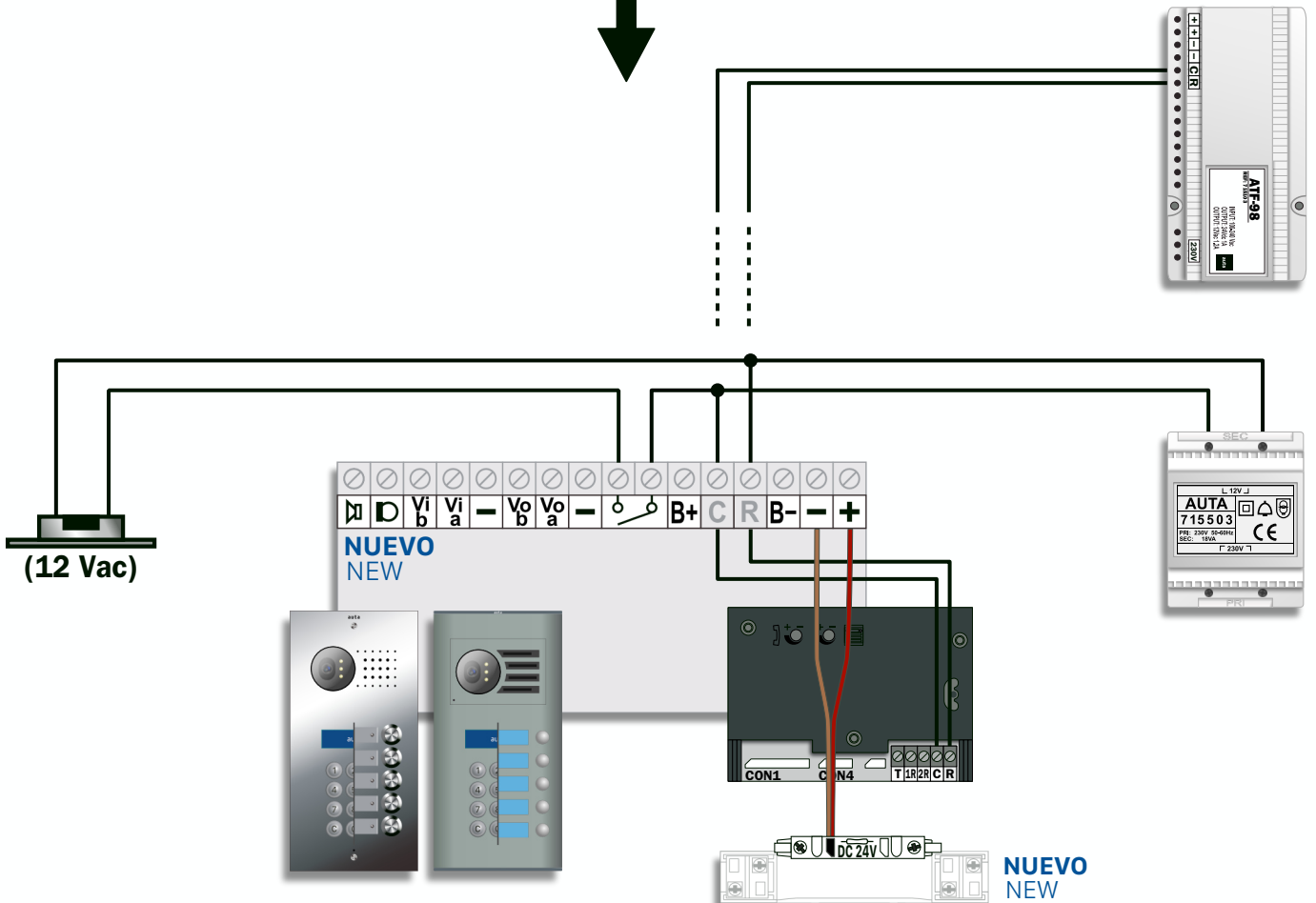
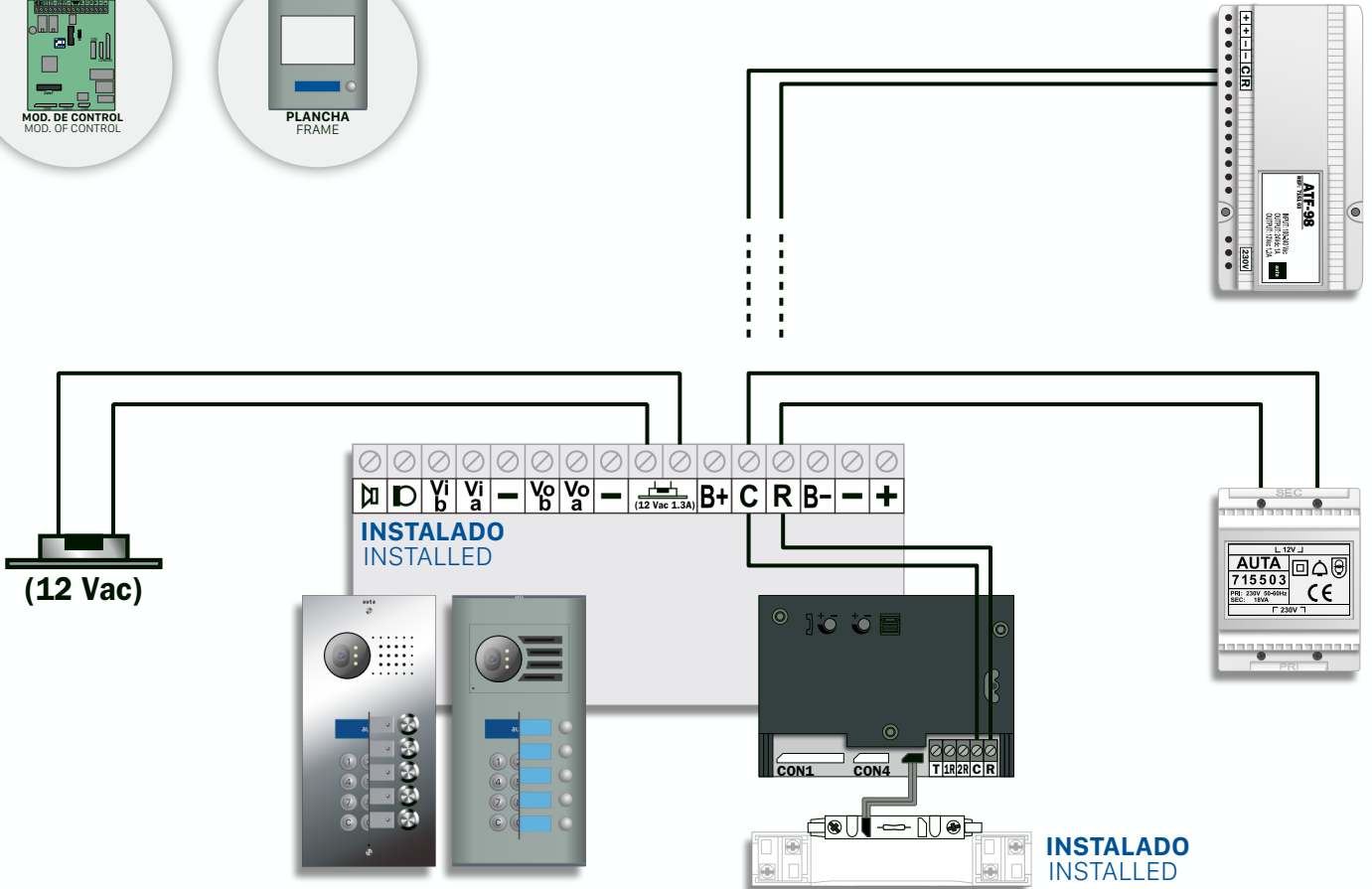
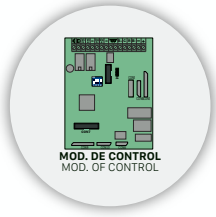

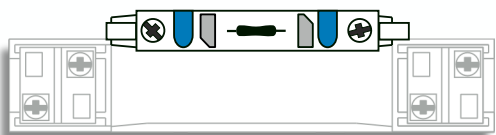

ILUMINACIÓN 12 Vca (509830)
ILLUMITATION 12 Vac (509830)



ILUMINACIÓN 24 Vcc (509834)
ILLUMITATION 24 Vdc (509834)

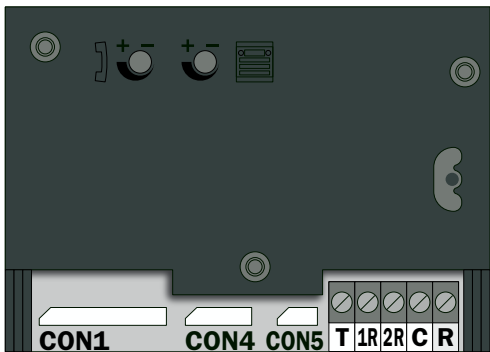

GRUPO FÓNICO EDIFICIO
SPEAKER FOR BUILDINGS



NUEVO GRUPO FÓNICO EDIFICIO
NEW SPEAKER FOR BUILDING

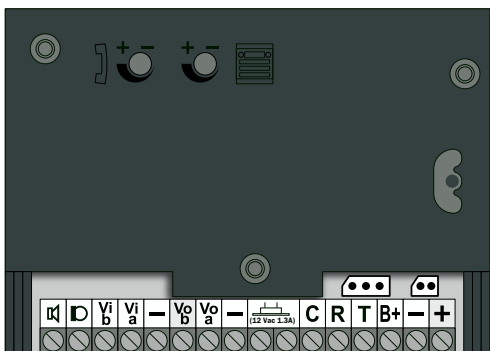

GRUPO FÓNICO KIT
SPEAKER FOR KIT

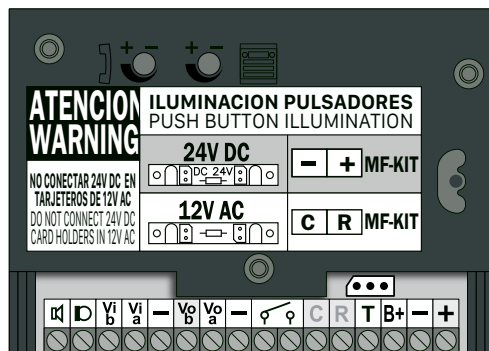

NUEVO GRUPO FÓNICO KIT
NEW SPEAKER FOR KIT

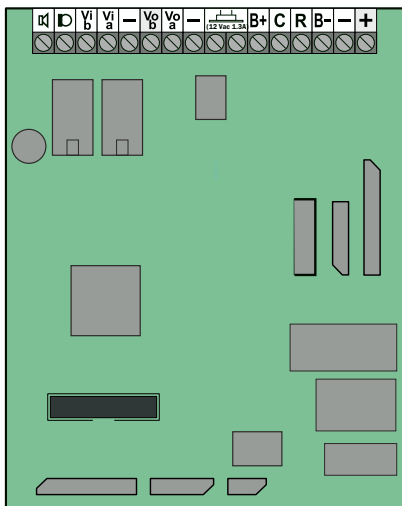

MÓDULO DE CONTROL
MODULE OF CONTROL

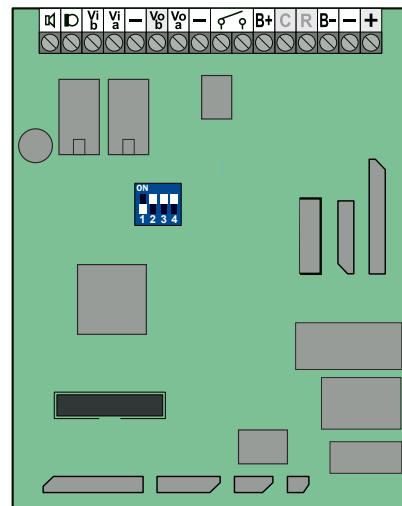

NUEVO MÓDULO DE CONTROL
NEW MODULE OF CONTROL



auta comunicaciones, s.l.
Pol. Ind. El Oliveral C/ C s/n 46394 Riba-Roja
(Valencia)
Tel.: +34 961 643 020 Fax: +34 961 665 286
e-mail: auta@auta.es