

auta

DIGITAL



REF: 750945
Blanco
White



REF: 750946
Acero
Steel



REF: 750944
Negro
Black

ES Monitor AVANT INTERCOM, NO-COAX

EN AVANT INTERCOM monitor, COAXLESS

Descripción Description

Monitor digital COLOR. Permite la intercomunicación de hasta 15 terminales y la comunicación con placas de calle. Incorpora una pantalla LCD COLOR 5.6", audio FULL DUPLEX, tecnología táctil, sistema OSD, salidas auxiliares multi-función, selección de melodías, funciones especiales.

COLOUR digital monitor. Allow intercom up to 15 terminals and the communication with external panels. It incorporates a LCD COLOUR 5.6", FULL DUPLEX audio, touch technology, OSD system, auxiliary multi-function outputs, selection of melodies, special functions.

Características Features

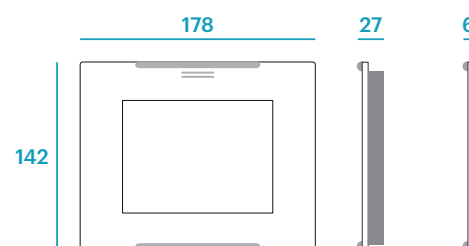
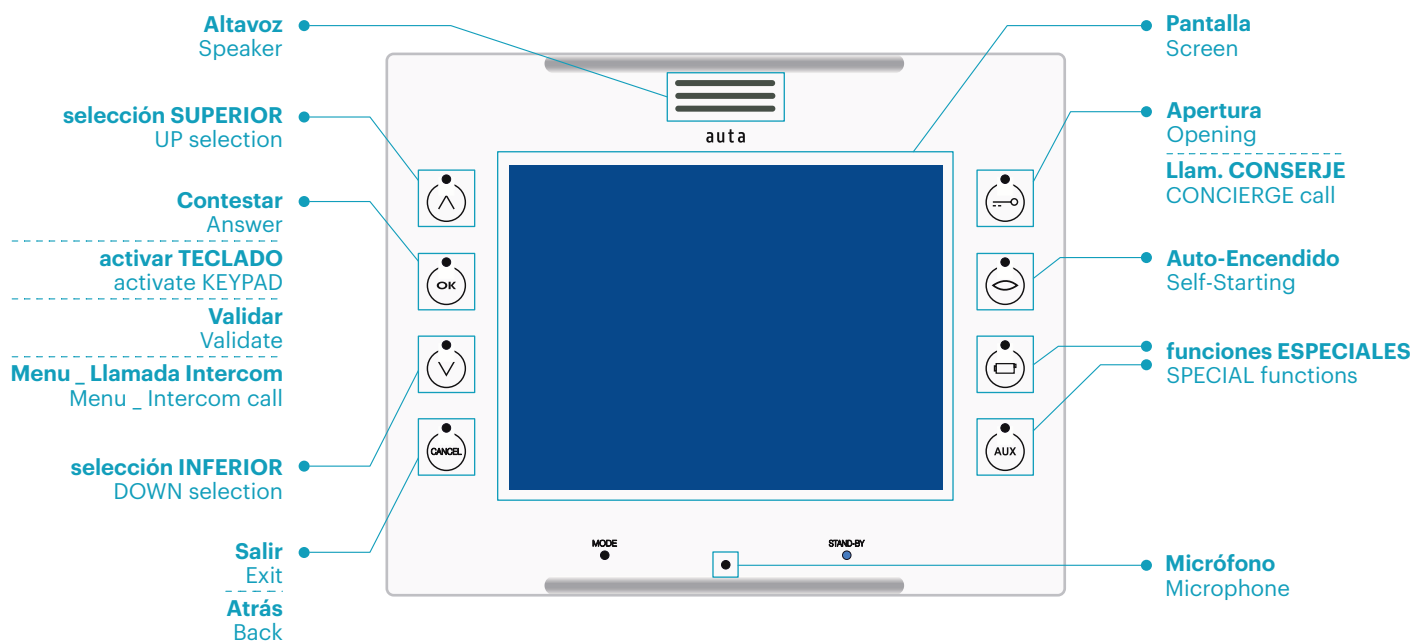

Montaje Mounting

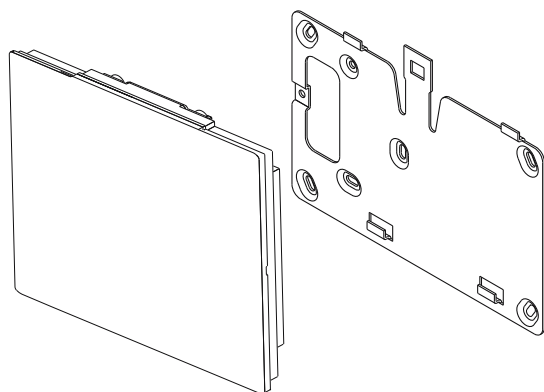

Superficie
(módulo de conexión 750920, NO INCLUIDO)
Surface
(connection bracket 750920, NOT INCLUDED)

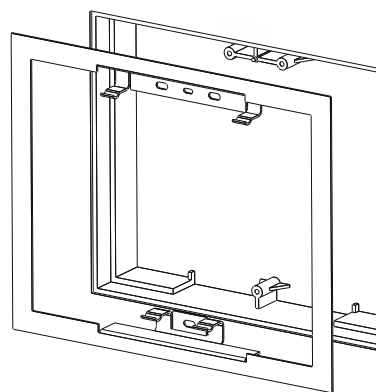

Empotrado
(caja 750921 y marco 750922, NO INCLUIDOS)
Flush
(Mounting box 750921 and frame 750922, NOT INCLUDED)

Instalación Installation

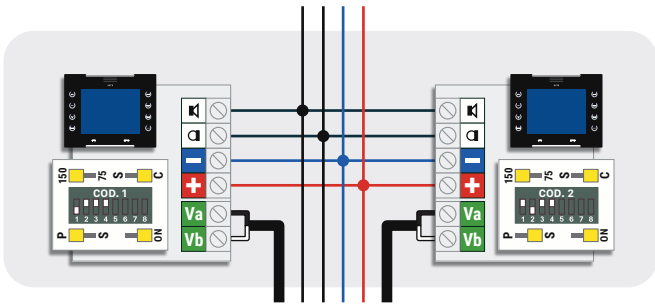

Manual de instalación INTERCOM
Installation manual INTERCOM

Configuración y conexiones Configuration and connections

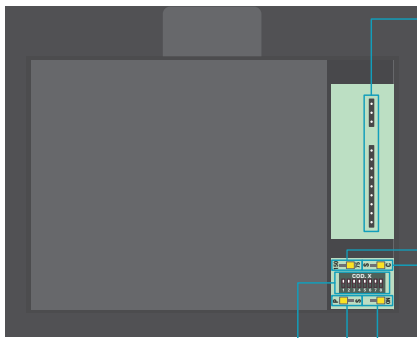

	Función Ding-Dong (entrada -24 Vcc)	Ding-Dong function (input -24Vdc)
	Timbre auxiliar (salida -24 Vcc, en llamada)	Auxiliary bell (-24 Vdc output, in call)
AUX	Pulsador auxiliar (salida -24 Vcc)	Auxiliary button (out -24 Vdc)
	Altavoz_Datos	Speaker_Data
	Micrófono	Microphone
+	+24 Vcc	+24 Vdc
-	-24 Vcc	-24 Vdc
Va	Video + (entrada_salida)	Video + (in_out)
Vb	Video - (entrada_salida)	Video - (in_out)

150 75 Sistema NO-COAX COAXLESS system — **150 75 NO USADO NOT USED**

S C Carga de video ON Video load ON — **S C Carga de video OFF Video load OFF**

ON Monitor ENCENDIDO Monitor ON — **ON Monitor APAGADO Monitor OFF**

P S Principal Main — **P S Secundario Secondary**

Código de Llamada INTERCOM (binario) INTERCOM call code (binary)



> Ajustes especiales Special settings



Solo recepción de llamadas
Only calls reception



Solo llamadas intercom
Only intercom calls



Modo prioritario SI
Priority mode ON

* Al activar este modo el teléfono responde a llamadas de placa que coincidan con su mismo código INTERCOM. Por ejemplo, si el teléfono tiene su código intercom como 2, al activar este modo, también responderá al pulsador de placa 2.

When this mode is activated the telephone will answer call from panel which match with its own INTERCOM code. For example, if the telephone has code 2 as intercom code, when that mode is activated, also will answer to the push-button 2 of the panel.





Funcionamiento

activación del teclado en reposo



EN REPOSO, para prevenir pulsaciones indeseadas, el monitor incorpora un sistema de seguridad en el que el teclado táctil permanece bloqueado hasta que se presiona el pulsador  **2 veces** rápidamente.



llamada y conversación

Cuando se recibe una llamada desde placa de calle el monitor comienza a sonar durante un tiempo máximo de 30 segundos. De forma estándar efectúa 4 timbrazos con intervalos de 4 segundos entre cada uno de ellos.



Durante el periodo de llamada la imagen aparece en la pantalla, el usuario podrá abrir directamente, presionando el pulsador , establecer una conversación presionando . La conversación tiene un máximo de 90 segundos. Si se desea continuar con la conversación se deberá presionar el pulsador  y a continuación .







llamada intercom

Estando el monitor en reposo presionar **2 veces** el pulsador , cuando se muestre el logo AVANT presionaremos de nuevo , aparecerá el menú intercom. En este menú nos encontramos un número al lado de cada uno de los pulsadores del lado derecho. Al presionar en el pulsador seleccionado se efectuará una llamada al monitor intercom que corresponda con dicho número.



Presionaremos los pulsadores de selección   para cambiar al siguiente grupo de monitores (15 disponibles). Si presionamos en el pulsador " TODOS " realizaremos una llamada a todos los monitores disponibles.



editar etiquetas intercom

Estando el monitor en reposo presionar **2 veces** el pulsador , cuando se muestre el logo AVANT presionaremos de nuevo , aparecerá el menú intercom. En este menú presionaremos otra vez el pulsador , entraremos en el modo " EDITAR ", que nos permitirá cambiar el número intercom asignado de fábrica por un nombre de hasta 6 caracteres (COCINA, SALON, etc...)



Para cambiar la etiqueta, estando en el modo " EDITAR ", presionaremos de nuevo  donde entraremos en el modo " ELEGIR " Seleccionamos la etiqueta que deseamos cambiar   y a continuación presionamos . El cursor empezará a parpadear en el primer carácter, cambiamos con los pulsadores de selección   y validamos con .

auto-encendido



Presionando el pulsador  y a continuación  el usuario podrá establecer comunicación con la PLACA DE CALLE / CÁMARA CCTV que desee en el caso de existir más de una en la instalación.

Con cada pulsación  el sistema conmutará automáticamente al siguiente dispositivo, mostrando imagen y permitiendo la apertura de este presionando el pulsador .

llamada a conserje

Si estando el monitor en reposo se presiona el pulsador  y a continuación  se efectuará una llamada a central de conserjería. Si el sistema no cuenta con ninguna central instalada el monitor mostrará en pantalla el mensaje "conserjería no disponible".

función vigilancia cctv

El monitor permite el control de placas y cámaras CCTV automáticamente. Se presiona el pulsador  y a continuación  Cada pulsación activará un dispositivo diferente. Para ello se ha de instalar cada cámara CCTV junto a un interface Auta digital.

función ding dong

El monitor permite prescindir del timbre interior de la vivienda, integrando así las dos llamadas (placa exterior y vivienda) en un solo dispositivo. Se diferenciarán automáticamente dichas llamadas con melodías y destellos diferentes. Para disponer de esta función tan solo se ha de conectar el pulsador de la vivienda interior al monitor.

funciones externas

El monitor dispone de 2 pulsadores independientes   que permiten realizar maniobras auxiliares, como el accionamiento de puertas de garaje, encendido de luces, riego, etc...



Para ello se usará un relé auxiliar Auta conectado al circuito de maniobra que se desee controlar.

Modo prioritario

Al activar este modo el teléfono es capaz de finalizar cualquier conversación que en ese momento este teniendo lugar en el sistema. Liberando así la línea de comunicación.

Ajustes

entrada y navegación por el menú de ajustes

Estando el monitor en reposo se presionará **2 veces** el pulsador , cuando aparezca la pantalla de bienvenida con el logo "Avant INTERCOM" pulsaremos 

Navegaremos por las distintas opciones con los pulsadores de selección  

Validaremos presionando el pulsador 

Para retroceder o salir del menú de ajustes presionaremos 

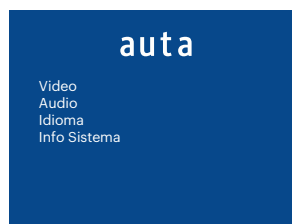

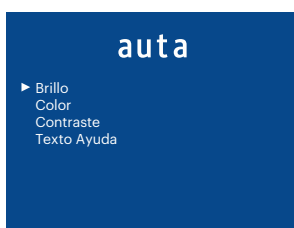

menú Video

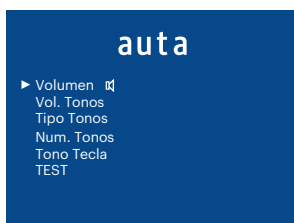

- Brillo** - Nivel de brillo en pantalla
- Color** - Nivel de color en pantalla
- Contraste** - Nivel de contraste en pantalla
- Texto Ayuda** - ON_OFF texto en pantalla

menú Audio



- Volumen**  - Nivel de audio en conversación
- Vol. Tonos** - Nivel de volumen en la llamada
- Tipo Tonos** - Selección de melodías en la llamada
- Num. Tonos** - Número de timbrazos de llamada
- Tono Tecla** - ON_OFF sonido de pulsación
- TEST** - Simulación de melodía y volumen seleccionados

menú Idioma



menú Info Sistema

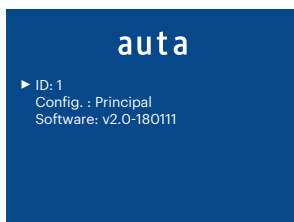

- ID** - Código de llamada asignado al monitor
- Config.** - Modo de funcionamiento asignado
- Software** - Versión de software del monitor

Functioning



keypad activation at standby

IN STANDBY, to prevent unwanted presses, the monitor incorporates a security system in which the touch keyboard remains locked until the push button is pressed **twice** quickly.

calling and conversation

When a call is received from the entrance panel, the monitor starts ringing for a maximum of 30 seconds. As standard, it performs 4 rings with intervals of 4 seconds between each of them.

During the call period the image appears on the screen, the user can open directly, pressing the button or establish a conversation pressing the button . The conversation has a maximum of 90 seconds. If you want to continue with the conversation, press the button and then .

intercom calling

When the monitor is in standby, press **2 times** the button , when the AVANT logo appears press again, the intercom menu will appear. In this menu we find a number next to each of the buttons on the right side. Pressing the selected button will make a call to the intercom monitor that corresponds to that number.

Press the selection buttons to change to the next group of monitors (15 available).

If we press on the "ALL" button we will make a call to all the available monitors.

edit intercom labels

When the monitor in standby, press **2 times** the button , when the AVANT logo appears press another time, the intercom menu will appear. In this menu we will press the button again, we will enter in the "EDIT" mode, which will allow us to change the intercom number assigned from the factory by a name of up to 6 characters (KITCHEN, LIVING ROOM, etc ...)

To change the label, being in the "EDIT" mode, we will press again where we will enter in the "CHOOSE" mode. We will select the label that we want to change and then press . The cursor will begin to blink in the first character, we will change it with the selection buttons and validate with .

self-starting

By pressing the button and then the user can establish communication with the PANEL / CCTV CAMERA that he wishes in the case of more than one is present in the installation.

With each press the system will automatically switch to the next device, showing the image and allowing the opening of it by pressing the button .

calling to concierge

If the monitor is in standby, by pressing the button and then , a call will be made to the concierge unit. If the system does not have a concierge unit installed, the monitor will show the message "concierge not available".

cctv surveillance function

The monitor allows the control of panels and CCTV cameras automatically. First we press the button and then . Each press activates a different device. To do this, each CCTV camera must be installed with an Auta digital interface.

ding dong function

The monitor allows to replace the interior bell of the house, this integrates the two calls (outside panel and house bell) in a single device. These calls will be differentiated with different melodies and flashes automatically. In order to have this function, you only have to connect the button of the house bell to the monitor.

external functions

The monitor has 2 independent push-buttons that allow auxiliary functions, such as garage doors, lights, irrigation, etc ...



To do this, an Auta auxiliary relay must be connected to the control circuit we want to control.

Priority mode

By activating this mode the phone is able to end any conversation that is currently taking place in the system. Leaving free the communication line.

Settings

entry and navigation through the settings menu

With the monitor is in standby, by pressing **2 times** the button  , when the welcome screen with the "Avant INTERCOM" logo appears, we will press 

We will navigate through the different options with the selection buttons  

We will validate by pressing the button 

To go back or exit the settings menu we will press 

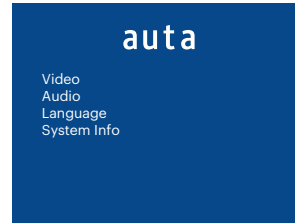

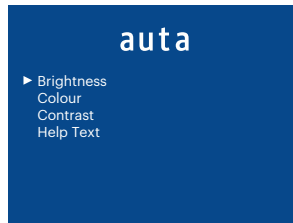
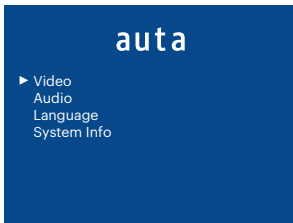

menu Video

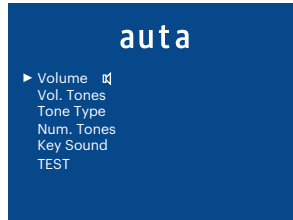
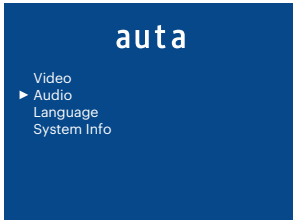

- Brightness** - Level of brightness at screen
- Colour** - Level of colour at screen
- Contrast** - Level of contrast at screen
- Help text** - ON_OFF on screen text

menu Audio



- Volume**  - Level of audio at conversation
- Vol. Tones** - Level of volume at calling
- Tone Type** - Melody selection
- Num. Tones** - Number of tones at calling
- Key Sound** - ON_OFF sound at pushbutton press
- TEST** - Simulation of the selected melody and volume

menu language

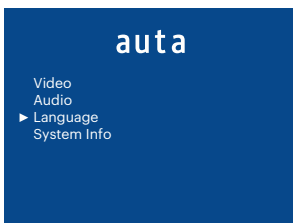

menu system info

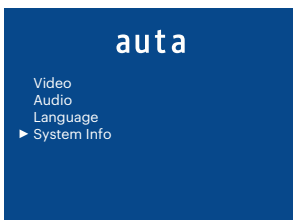

- ID** - Calling code assigned to the monitor
- Config.** - Working mode assigned
- Software** - Software version of the monitor

Funciones especiales Special functions

Para poder acceder al menú que permite la gestión de funciones especiales, por favor escanee el siguiente código QR.



To access the menu that allows the management of special functions, please scan the following QR code.

