

auta

VISUALTECH



REF: 750908
Blanco
White



REF: 750909
Acero
Steel



REF: 750907
Negro
Black

ES Monitor AVANT, VISUALTECH 5H

EN AVANT monitor, VISUALTECH 5W

Descripción Description

Monitor digital COLOR. Permite ser instalado en cualquier sistema Auta digital VISUALTECH 5H. Incorpora una pantalla LCD COLOR 5.6", audio FULL DUPLEX, tecnología táctil, sistema OSD, salidas auxiliares multi-función, selección de melodías, funciones especiales.

COLOUR digital monitor. It can be installed on any Auta VISUALTECH 5W digital system. It incorporates a LCD COLOUR 5.6", FULL DUPLEX audio, touch technology, OSD system, auxiliary multi-function outputs, selection of melodies, special functions.

Características Features

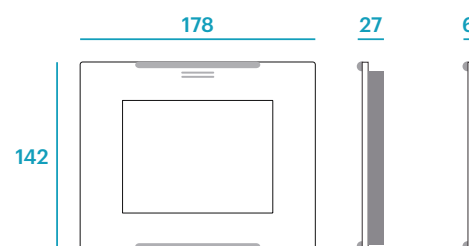
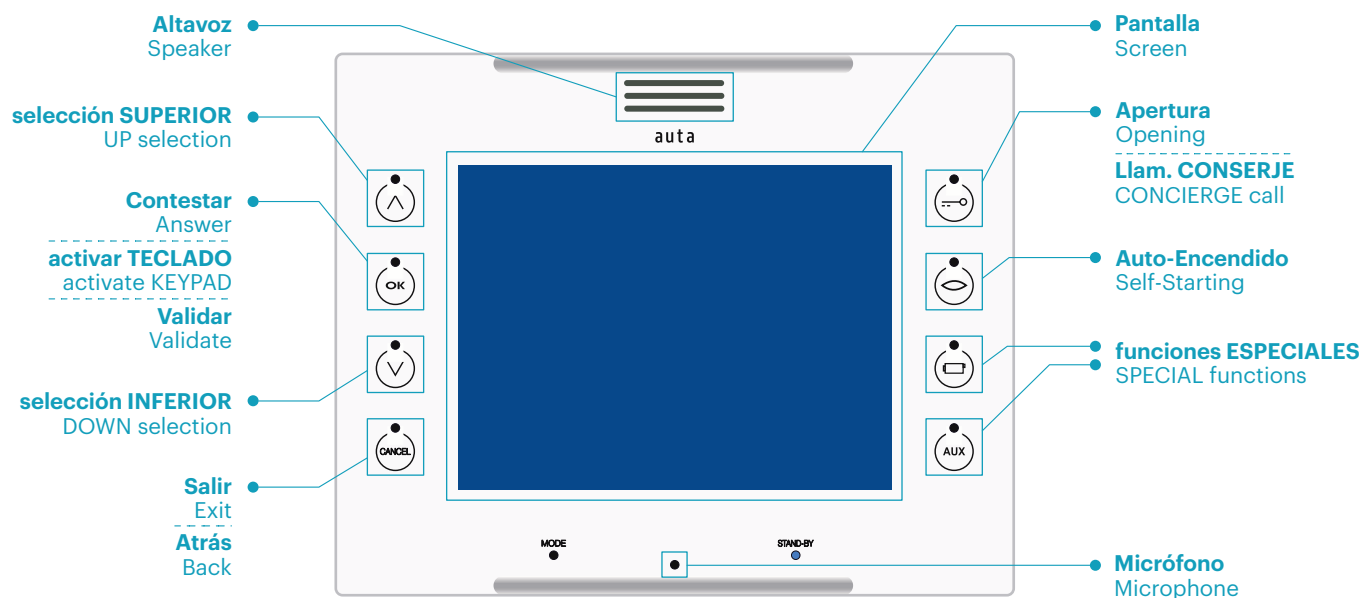

Montaje Mounting

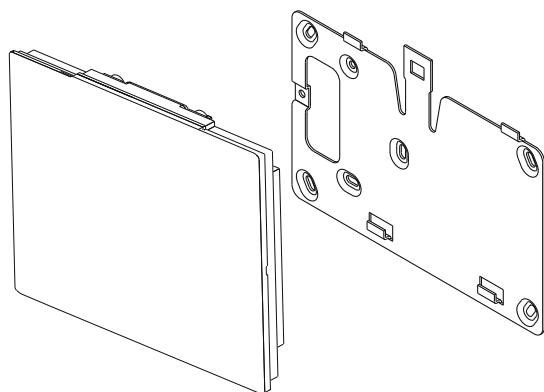

Superficie
(módulo de conexión 750920, NO INCLUIDO)
Surface
(connection bracket 750920, NOT INCLUDED)

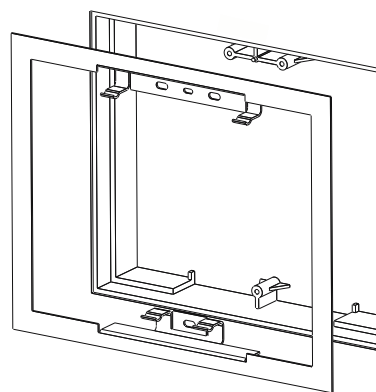

Empotrado
(caja 750921 y marco 750922, NO INCLUIDOS)
Flush
(Mounting box 750921 and frame 750922, NOT INCLUDED)

Instalación Installation

Monitor como principal Monitor as main

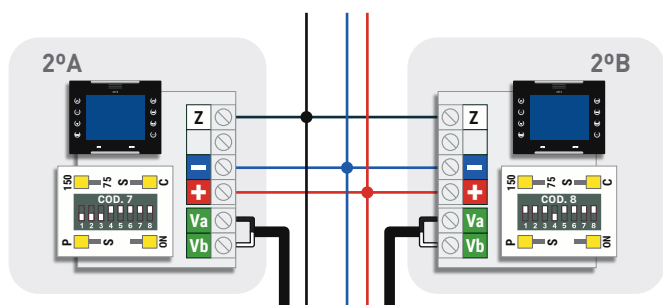

Monitor como secundario Monitor as secondary

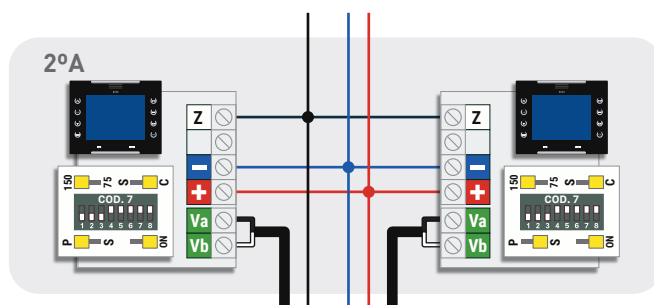

Manual de instalación VIDEO 5H
Installation manual VIDEO 5W

Configuración y conexiones Configuration and connections

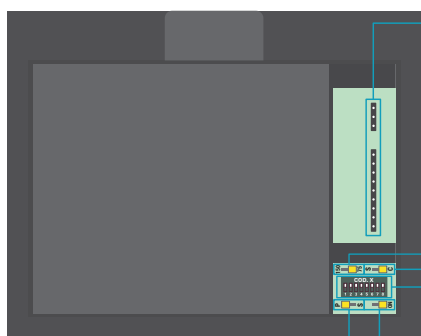

	Función Ding-Dong (entrada -24 Vcc)	Ding-Dong function (input -24Vdc)
	Timbre auxiliar (salida -24 Vcc, en llamada)	Auxiliary bell (-24 Vdc output, in call)
AUX	Pulsador auxiliar (salida -24 Vcc)	Auxiliary button (out -24 Vdc)
Z	Audio_Datos	Audio_Data
+	+24 Vcc	+24 Vdc
-	-24 Vcc	-24 Vdc
Va	Video + (entrada_salida)	Video + (in_out)
Vb	Video - (entrada_salida)	Video - (in_out)

150 75 **NO USADO NOT USED** — 150 75 **Sistema VISUALTECH 5H VISUALTECH 5W system**

S C **Carga de video ON Video load ON** — S C **Carga de video OFF Video load OFF**



Configuración del sistema digital
Digital system configuration





ON **Monitor ENCENDIDO Monitor ON** — ON **Monitor APAGADO Monitor OFF**

P S **Principal Main** — P S **Secundario Secondary**

Funcionamiento



llamada y conversación

Cuando se recibe una llamada desde placa de calle el monitor comienza a sonar durante un tiempo máximo de 30 segundos. De forma estándar efectúa 4 timbrazos con intervalos de 4 segundos entre cada uno de ellos.



Durante el periodo de llamada la imagen aparece en la pantalla, el usuario podrá abrir directamente, presionando el pulsador  , establecer una conversación presionando  . La conversación tiene un máximo de 90 segundos. Si se desea continuar con la conversación se deberá presionar **2 veces** el pulsador  y a continuación .

auto-encendido



Presionando **2 veces** el pulsador  y a continuación  el usuario podrá establecer comunicación con la PLACA DE CALLE / CÁMARA CCTV que desee en el caso de existir más de una en la instalación.

Con cada pulsación  el sistema conmutará automáticamente al siguiente dispositivo, mostrando imagen y permitiendo la apertura de este presionando el pulsador .

llamada a conserje

Si estando el monitor en reposo se presiona **2 veces** el pulsador  y a continuación  se efectuará una llamada a central de conserjería. Si el sistema no cuenta con ninguna central instalada el monitor mostrará en pantalla el mensaje "conserjería no disponible" .

función vigilancia cctv

El monitor permite el control de placas y cámaras CCTV automáticamente. Se presiona **2 veces** el pulsador  y a continuación  Cada pulsación activará un dispositivo diferente. Para ello se ha de instalar cada cámara CCTV junto a un interface Auta digital.

función ding dong

El monitor permite prescindir del timbre interior de la vivienda, integrando así las dos llamadas (placa exterior y vivienda) en un solo dispositivo. Se diferenciarán automáticamente dichas llamadas con melodías y destellos diferentes. Para disponer de esta función tan solo se ha de conectar el pulsador de la vivienda interior al monitor.



funciones externas

El monitor dispone de 2 pulsadores independientes   que permiten realizar maniobras auxiliares, como el accionamiento de puertas de garaje, encendido de luces, riego, etc...

Para ello se usará un relé auxiliar Auta conectado al circuito de maniobra que se desee controlar.

Ajustes

entrada y navegación por el menú de ajustes

Estando el monitor en reposo se presionará **2 veces** el pulsador , cuando aparezca la pantalla de bienvenida con el logo "Avant" pulsaremos de nuevo 

Navegaremos por las distintas opciones con los pulsadores de selección  

Validaremos presionando el pulsador 

Para retroceder o salir del menú de ajustes presionaremos 

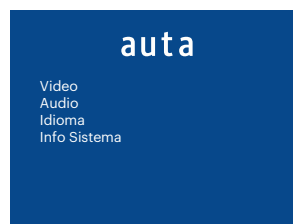

menú Video

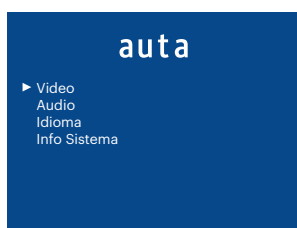

- Brillo** - Nivel de brillo en pantalla
- Color** - Nivel de color en pantalla
- Contraste** - Nivel de contraste en pantalla
- Texto Ayuda** - ON_OFF texto en pantalla

menú Audio



- Volumen**  - Nivel de audio en conversación
- Vol. Tonos** - Nivel de volumen en la llamada
- Tipo Tonos** - Selección de melodías en la llamada
- Num. Tonos** - Número de timbrados de llamada
- Tono Tecla** - ON_OFF sonido de pulsación
- TEST** - Simulación de melodía y volumen seleccionados

menú Idioma



menú Info Sistema

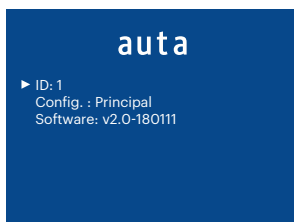





- ID** - Código de llamada asignado al monitor
- Config.** - Modo de funcionamiento asignado
- Software** - Versión de software del monitor



Functioning



calling and conversation

When a call is received from the entrance panel, the monitor starts ringing for a maximum of 30 seconds. As standard, it performs 4 rings with intervals of 4 seconds between each of them.



During the call period the image appears on the screen, the user can open directly, pressing the button  or establish a conversation pressing the button . The conversation has a maximum of 90 seconds. If you want to continue with the conversation, press **2 times** the button  and then .

self-starting



By pressings **2 times** the button  and then  the user can establish communication with the PANEL / CCTV CAMERA that he wishes in the case of more than one is present in the installation.

With each press  the system will automatically switch to the next device, showing the image and allowing the opening of it by pressing the button .

calling to concierge

If the monitor is in standby, by pressing **2 times** the button  and then , a call will be made to the concierge unit. If the system does not have a concierge unit installed, the monitor will show the message "concierge not available".



cctv surveillance function

The monitor allows the control of panels and CCTV cameras automatically. First we press **2 times** the button  and then . Each press activates a different device. To do this, each CCTV camera must be installed with an Auta digital interface.

ding dong function

The monitor allows to replace the interior bell of the house, this integrates the two calls (outside panel and house bell) in a single device. These calls will be differentiated with different melodies and flashes automatically. In order to have this function, you only have to connect the button of the house bell to the monitor.

external functions

The monitor has 2 independent push-buttons   that allow auxiliary functions, such as garage doors, lights, irrigation, etc ...

To do this, an Auta auxiliary relay must be connected to the control circuit we want to control.

Settings

entry and navigation through the settings menu

With the monitor is in standby, by pressing **2 times** the button , when the welcome screen with the "Avant" logo appears, we will press again

We will navigate through the different options with the selection buttons

We will validate by pressing the button

To go back or exit the settings menu we will press

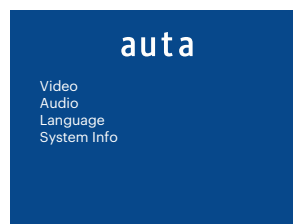

menu Video

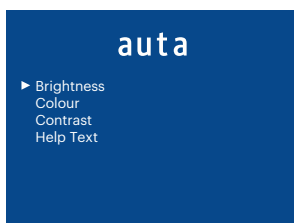
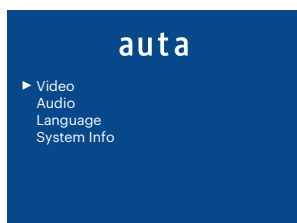

- Brightness** - Level of brightness at screen
- Colour** - Level of colour at screen
- Contrast** - Level of contrast at screen
- Help text** - ON_OFF on screen text

menu Audio

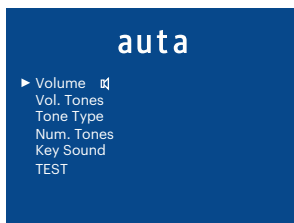
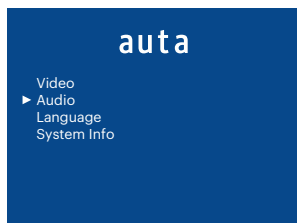

- Volume** - Level of audio at conversation
- Vol. Tones** - Level of volume at calling
- Tone Type** - Melody selection
- Num. Tones** - Number of tones at calling
- Key Sound** - ON_OFF sound at pushbutton press
- TEST** - Simulation of the selected melody and volume

menu language

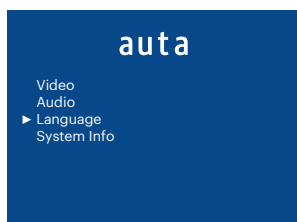

menu system info

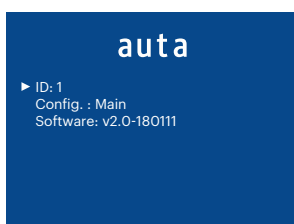
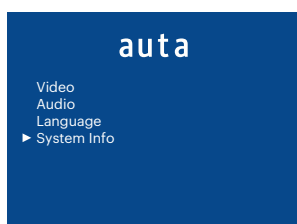

- ID** - Calling code assigned to the monitor
- Config.** - Working mode assigned
- Software** - Software version of the monitor

Funciones especiales Special functions

Para poder acceder al menú que permite la gestión de funciones especiales, por favor escanee el siguiente código QR.



To access the menu that allows the management of special functions, please scan the following QR code.

