

auta

DIGITAL



REF: 751310
Negro
Black



REF: 751311
Blanco
White

ES Monitor E-COMPACT, COAX

EN E-COMPACT monitor, COAX

auta

Bringing people together

Descripción Description

Monitor digital COLOR. Permite ser instalado en cualquier sistema Auta digital 4 + COAX. Incorpora una pantalla LCD COLOR 4.3", audio FULL DUPLEX, salidas auxiliares multi-función, selección de melodías, funciones especiales.

COLOUR digital monitor. It can be installed on any Auta 4 + COAX digital system. It incorporates a LCD COLOUR 4.3", FULL DUPLEX audio, auxiliary multi-function outputs, selection of melodies, special functions.

Características Features

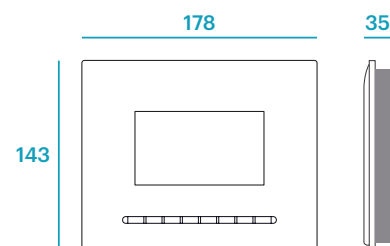
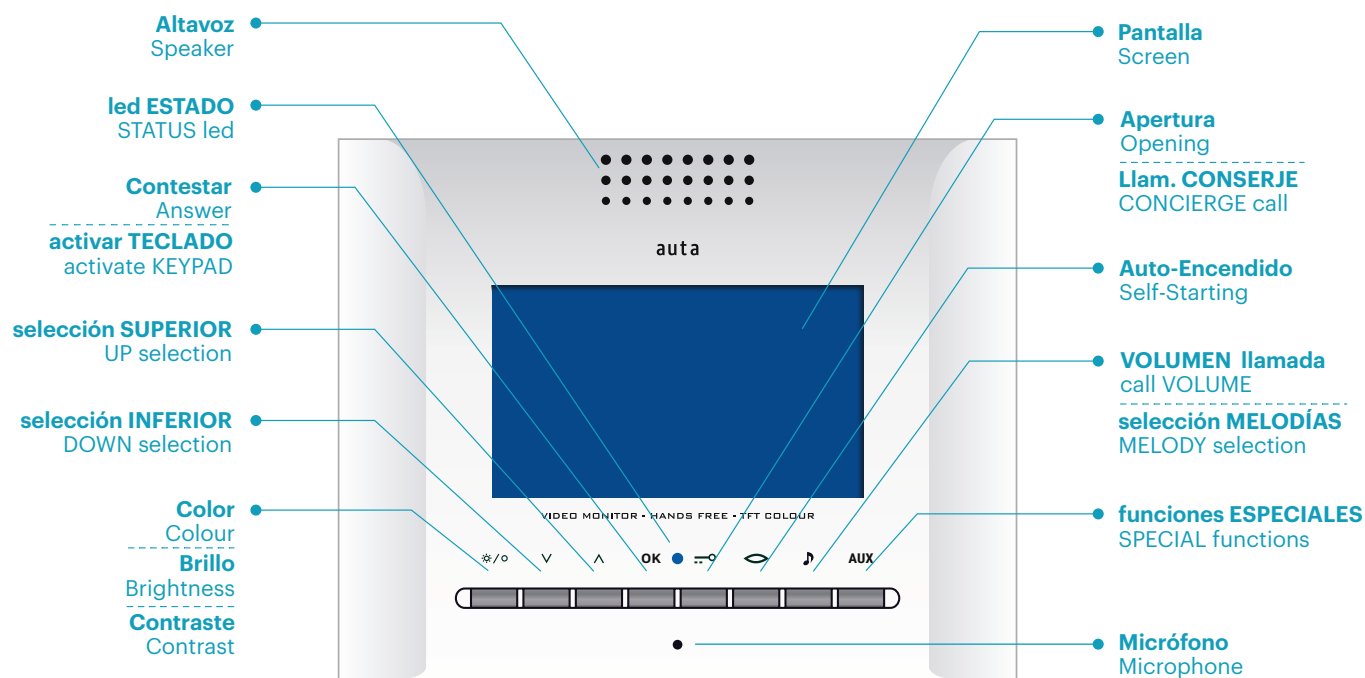

Montaje Mounting

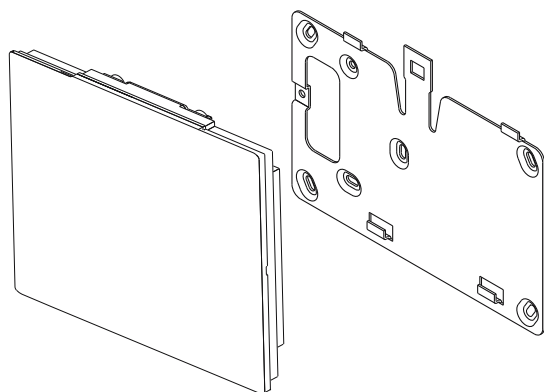

Superficie
(módulo de conexión 750920, NO INCLUIDO)
Surface
(connection bracket 750920, NOT INCLUDED)

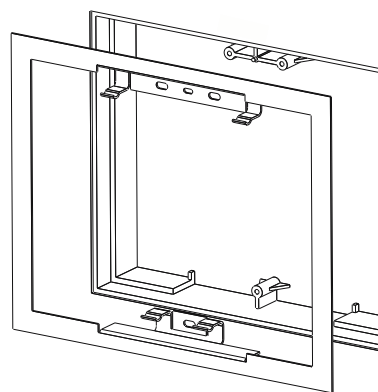

Empotrado
(caja 750921 y marco 750922, NO INCLUIDOS)
Flush
(Mounting box 750921 and frame 750922, NOT INCLUDED)

Instalación Installation

Monitor como principal Monitor as main

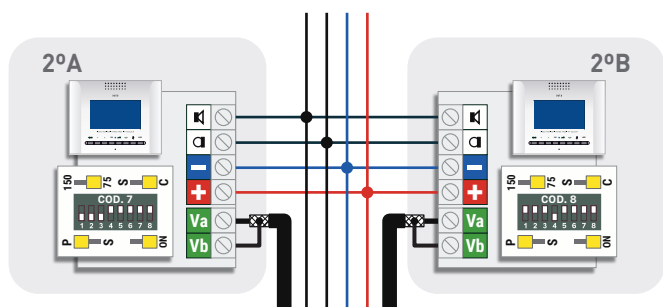

Monitor como secundario Monitor as secondary

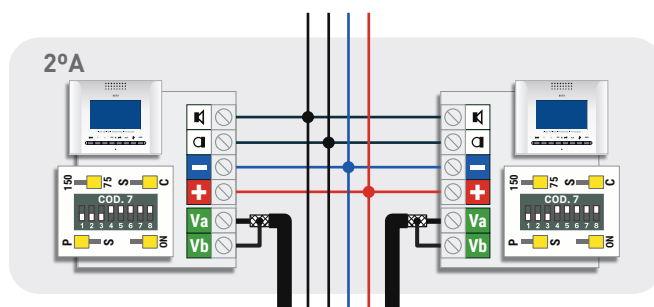

Manual de instalación VIDEO COAX
Installation manual VIDEO COAX

Configuración y conexiones Configuration and connections

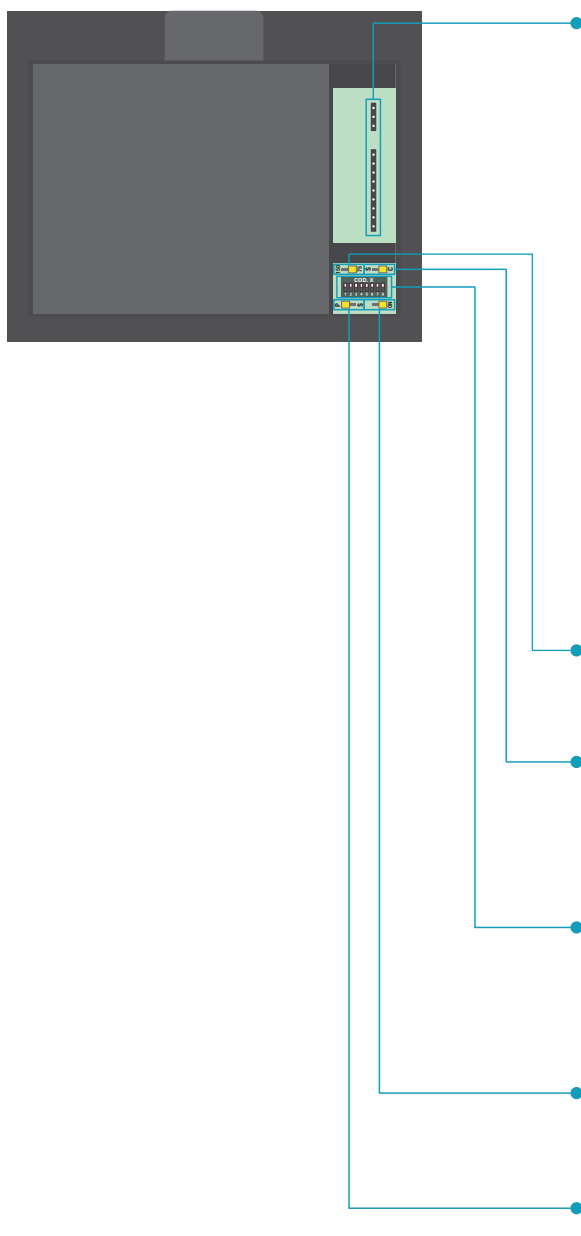

	Función Ding-Dong (entrada -24 Vcc)	Ding-Dong function (input -24Vdc)
	Timbre auxiliar (salida -24 Vcc, en llamada)	Auxiliary bell (-24 Vdc output, in call)
AUX	Pulsador auxiliar (salida -24 Vcc)	Auxiliary button (out -24 Vdc)
	Altavoz_Datos	Speaker_Data
	Micrófono	Microphone
+	+24 Vcc	+24 Vdc
-	-24 Vcc	-24 Vdc
Va	Video + (entrada_salida)	Video + (in_out)
Vb	Video - (entrada_salida)	Video - (in_out)

150 75 **Sistema COAX** 150 75 **NO USADO**
COAX system NOT USED

S C **Carga de video ON** S C **Carga de video OFF**
Video load ON Video load OFF



Configuración del sistema digital
Digital system configuration

Monitor ENCENDIDO **Monitor APAGADO**
Monitor ON Monitor OFF

P S **Principal** S **Secundario**
Main Secondary





Funcionamiento

activación del teclado en reposo

EN REPOSO, para prevenir pulsaciones indeseadas, el monitor incorpora un sistema de seguridad en el que el teclado táctil permanece bloqueado hasta que se presiona el pulsador 

llamada y conversación

Cuando se recibe una llamada desde placa de calle el monitor comienza a sonar durante un tiempo máximo de 30 segundos. De forma estándar efectúa 4 timbrazos con intervalos de 4 segundos entre cada uno de ellos.



Durante el periodo de llamada la imagen aparece en la pantalla, el usuario podrá abrir directamente, presionando el pulsador , establecer una conversación presionando . La conversación tiene un máximo de 90 segundos. Si se desea continuar con la conversación se deberá presionar el pulsador  y a continuación 

auto-encendido



Presionando el pulsador  y a continuación  el usuario podrá establecer comunicación con la PLACA DE CALLE / CÁMARA CCTV que desee en el caso de existir más de una en la instalación.

Con cada pulsación  el sistema conmutará automáticamente al siguiente dispositivo, mostrando imagen y permitiendo la apertura de este presionando el pulsador 

llamada a conserje

Si estando el monitor en reposo se presiona el pulsador  y a continuación  se efectuará una llamada a central de conserjería. Si el sistema no cuenta con ninguna central instalada el monitor emitirá un aviso de error.

selección de melodías y volumen de llamada

Estando el monitor en reposo se ha de presionar el pulsador  y a continuación el pulsador . Con cada pulsación seleccionaremos una melodía y un volumen de llamada diferente.

Existen 4 melodías de llamada y 2 niveles de volumen para cada una (MEDIO - ALTO)

función ding dong

El monitor permite prescindir del timbre interior de la vivienda, integrando así las dos llamadas (placa exterior y vivienda) en un solo dispositivo. Se diferenciarán automáticamente dichas llamadas con melodías y destellos diferentes. Para disponer de esta función tan solo se ha de conectar el pulsador de la vivienda interior al monitor.

función vigilancia cctv

El monitor permite el control de placas y cámaras CCTV automáticamente. Primero se presiona el pulsador  y a continuación  Cada pulsación en el pulsador  activará un dispositivo diferente. Para ello se ha de instalar cada cámara CCTV junto a un interface Auta digital.

funciones externas

El monitor dispone de 1 pulsador que permiten realizar maniobras auxiliares, como el accionamiento de puertas de garaje, encendido de luces, riego, etc...

Para ello se usará un relé auxiliar Auta conectado al circuito de maniobra que se desee controlar.





Functioning

keypad activation at standby



IN STANDBY, to prevent unwanted presses, the monitor incorporates a security system in which the touch keyboard remains locked until the push button  is pressed.



calling and conversation

When a call is received from the entrance panel, the monitor starts ringing for a maximum of 30 seconds. As standard, it performs 4 rings with intervals of 4 seconds between each of them.



During the call period the image appears on the screen, the user can open directly, pressing the button  or establish a conversation pressing the button . The conversation has a maximum of 90 seconds. If you want to continue with the conversation, press the button  and then .

self-starting

By pressings the button  and then  the user can establish communication with the PANEL / CCTV CAMERA that he wishes in the case of more than one is present in the installation.

With each press  the system will automatically switch to the next device, showing the image and allowing the opening of it by pressing the button .

calling to concierge

If the monitor is in standby, by pressing the button  and then , a call will be made to the concierge unit. If the system does not have a concierge unit installed, the monitor will emit an error beep.

melody selection and adjust of the calling volume



If the monitor is in standby, press  and then . With each press  we will select a different melody and a different calling volume.

There is 4 call melodies and 2 volume levels for each one (MEDIUM and HIGH)

ding dong function

The monitor allows to replace the interior bell of the house, this integrates the two calls (outside panel and house bell) in a single device. These calls will be differentiated with different melodies and flashes automatically. In order to have this function, you only have to connect the button of the house bell to the monitor.

cctv surveillance function

The monitor allows the control of panels and CCTV cameras automatically. First we press the button  and then . Each press on the button  activates a different device. To do this, each CCTV camera must be installed with an Auta digital interface.

external functions

The monitor has 1 independent push-button that allow auxiliary functions, such as garage doors, lights, irrigation, etc ...

To do this, an Auta auxiliary relay must be connected to the control circuit we want to control.

Funciones especiales Special functions

Programación de funciones especiales Programming of special functions

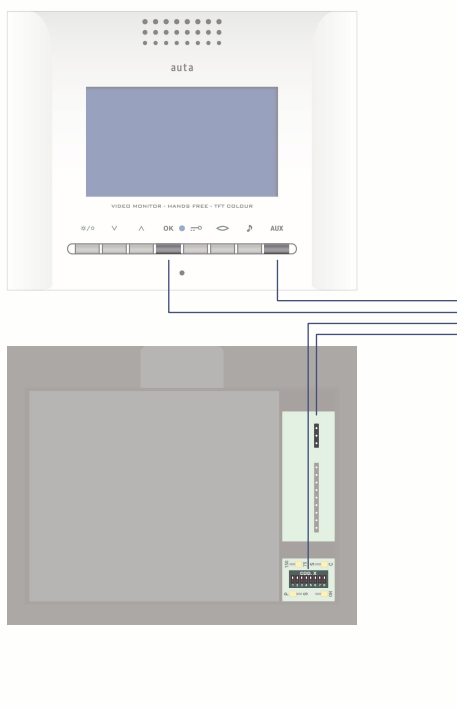

























- 1° **Apagar el monitor** Turn OFF the monitor
- 2° **Anotar configuración del monitor** Write down monitor settings
- 3° **Realizar un puente como indica el dibujo** Do a bridge as picture shows

- 4° **Configurar el código de función (tabla)** Set the desired function code (template)

- 5° **Encender el monitor y antes de 5 segundos presionar  luego , LED encendido** Turn ON the monitor and before 5 seconds press  until , LED on
- 6° **Validar el código presionando ** Validate the code by pressing 
- 7° **Apagar el monitor** Turn OFF the monitor
- 8° **Deshacer el puente realizado en el paso 3** Remove the bridge done in the step 3
- 9° **Restablecer configuración del monitor anotada en el paso 2** Restore the monitor configuration written in the step 2
- 10° **Encender el monitor** Turn ON the monitor

Tabla de funciones especiales Special functions table

FUNCIÓN FUNCTION		BINARIO BINARY			
1, 2, 3, 4	Nº de tonos de llamada Nº of calling tones	 1 tono 1 tone	 2 tonos 2 tones	 3 tonos 3 tones	 4 tonos 4 tones
5	Modo silencio, la salida  se activa tantas veces como el Nº de tonos Silent mode, the output  is activated as many times as the Nº of tones				
6	La salida  se activa durante 30 segundos al recibir una llamada The output  is activated during 30 seconds when a call is received				
7	Salida AUX configurada en modo pulso (1 seg.), fábrica, o modo conmutador (ON_OFF) AUX output set as pulse mode (1 sec.), factory, or in toggle mode (ON_OFF)				
9	La entrada  pasa a ser entrada remota de apertura de puerta. Input  becomes in remote door release input.				
255	Valores de fábrica Factory settings	