

# auta

## VISUALTECH



**ES** MÓDULO DE CONTROL ALFANUMÉRICO 600017

**EN** MODULE OF CONTROL ALPHANUMERIC 600017

**auta**

Bringing people together

## Índice

|   |    |
|---|----|
| Descripción .....                                 | 1  |
| Características .....                             | 1  |
| Conexión .....                                    | 2  |
| Ejemplos de instalación, AUDIO 3H .....           | 3  |
| Ejemplos de instalación, VIDEO 5H .....           | 4  |
| Menú AJUSTES .....                                | 5  |
| Configuración                                     |    |
| Placa Teclado + Pulsadores (tabla ESTANDAR) ..... | 6  |
| Placa Teclado + Pulsadores (tabla LARGA).....     | 7  |
| Placa Pulsadores.....                             | 8  |
| Llamada a vivienda.....                           | 9  |
| Códigos que genera cada pulsador .....            | 10 |
| Tabla de códigos binarios .....                   | 11 |
| Guía de instalación.....                          | 12 |

## Index

|   |    |
|---|----|
| Description.....                                  | 1  |
| Features.....                                     | 1  |
| Connection .....                                  | 2  |
| Examples of installation, AUDIO 3W .....          | 3  |
| Examples of installation, VIDEO 5W.....           | 4  |
| SETTINGS menu.....                                | 5  |
| Configuration                                     |    |
| Keypad + Push-buttons panel (STANDARD table)..... | 6  |
| Keypad + Push-buttons panel (LARGE table).....    | 7  |
| Push-buttons panel .....                          | 8  |
| Call to flat.....                                 | 9  |
| Codes that generates every push-button.....       | 10 |
| Binary codes table .....                          | 11 |
| Installation guide .....                          | 12 |

## Descripción Description

Módulo de control para sistemas digitales Auta. Compatible con instalaciones VISUALTECH AUDIO 3H y VISUALTECH VIDEO 5H. Permite la gestión de placas mixtas, teclado + pulsador (hasta 12 pulsadores) y placas con solo pulsadores. El sistema permite la marcación en dos pasos presionando primero el número de planta y seguidamente la letra de la vivienda. Incorpora gestión de tiempos de apertura, códigos de acceso, etc...

Module of control for Auta digital systems. Compatible with VISUALTECH AUDIO 3W and VISUALTECH VIDEO 5W installations. It allows the management of mixed panels, keyboard + button (up to 12 buttons) and panels with only buttons. The system allows two-step dealing by first pressing the floor number and then the housing letter. It incorporates management of opening times, access codes, etc ...

## Características Features

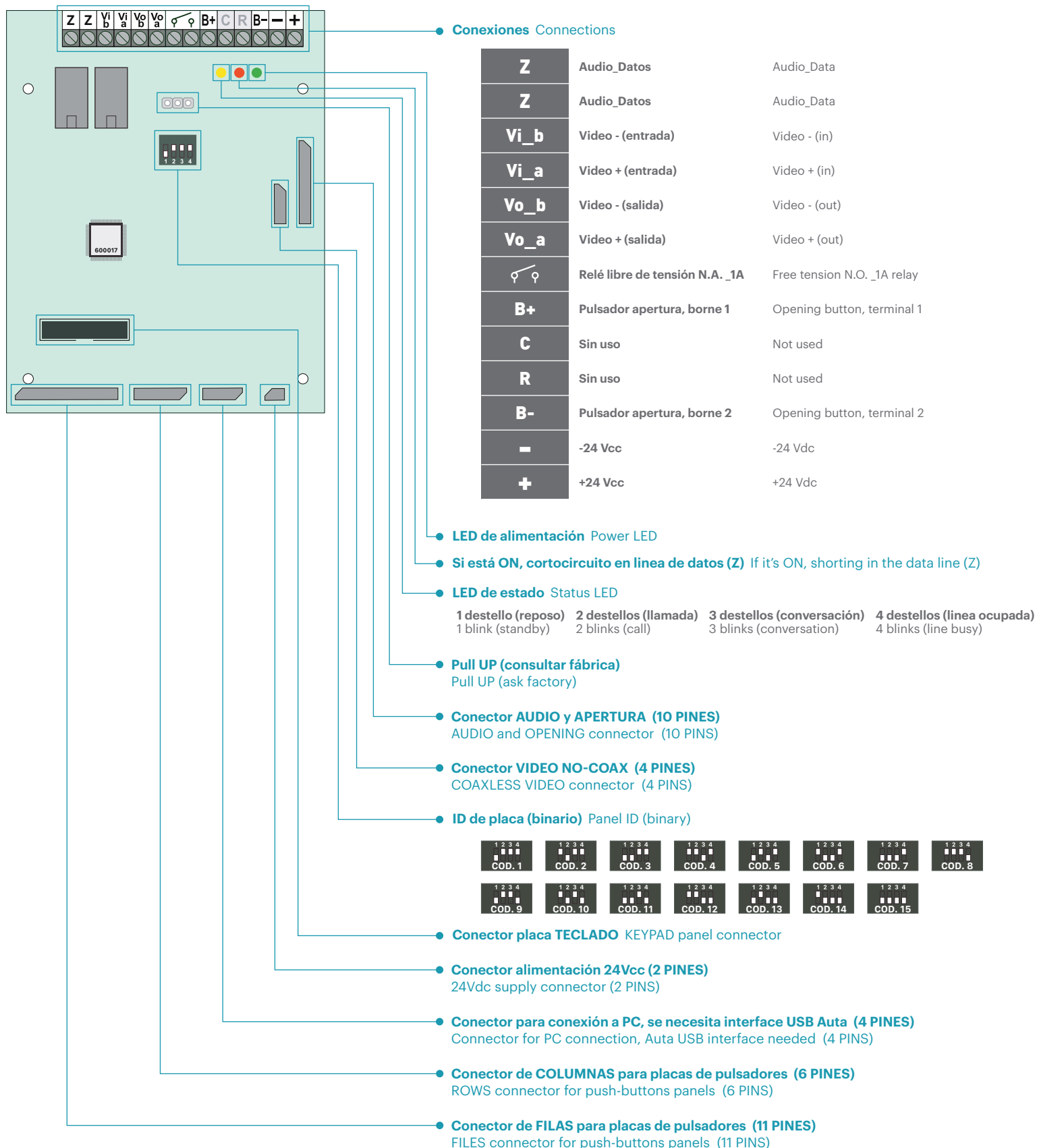

## Conexión Connection

### PLACA DE TECLADO + PULSADORES KEYPAD + PUSH-BUTTONS PANEL

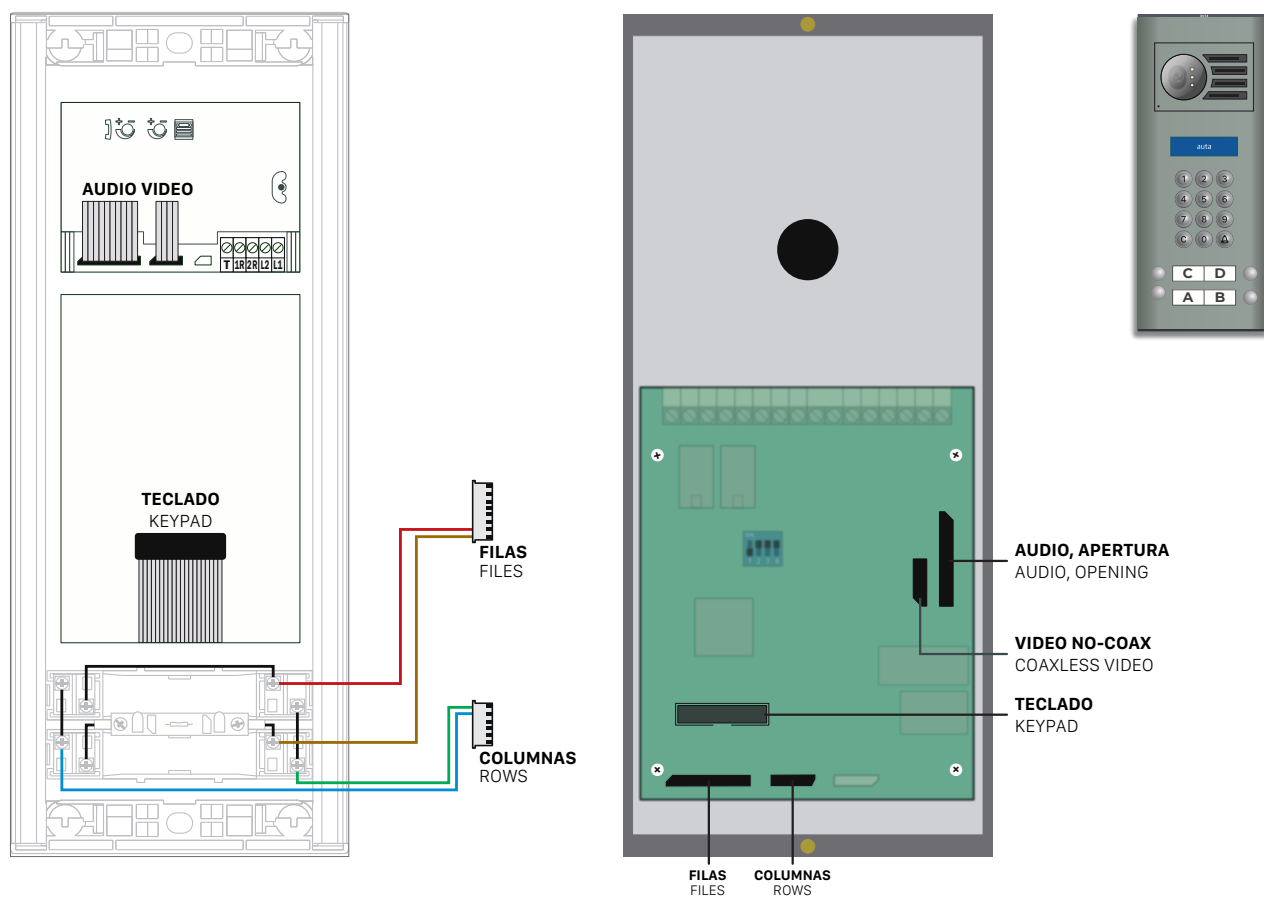

### PLACA DE PULSADORES PUSH-BUTTON PANEL

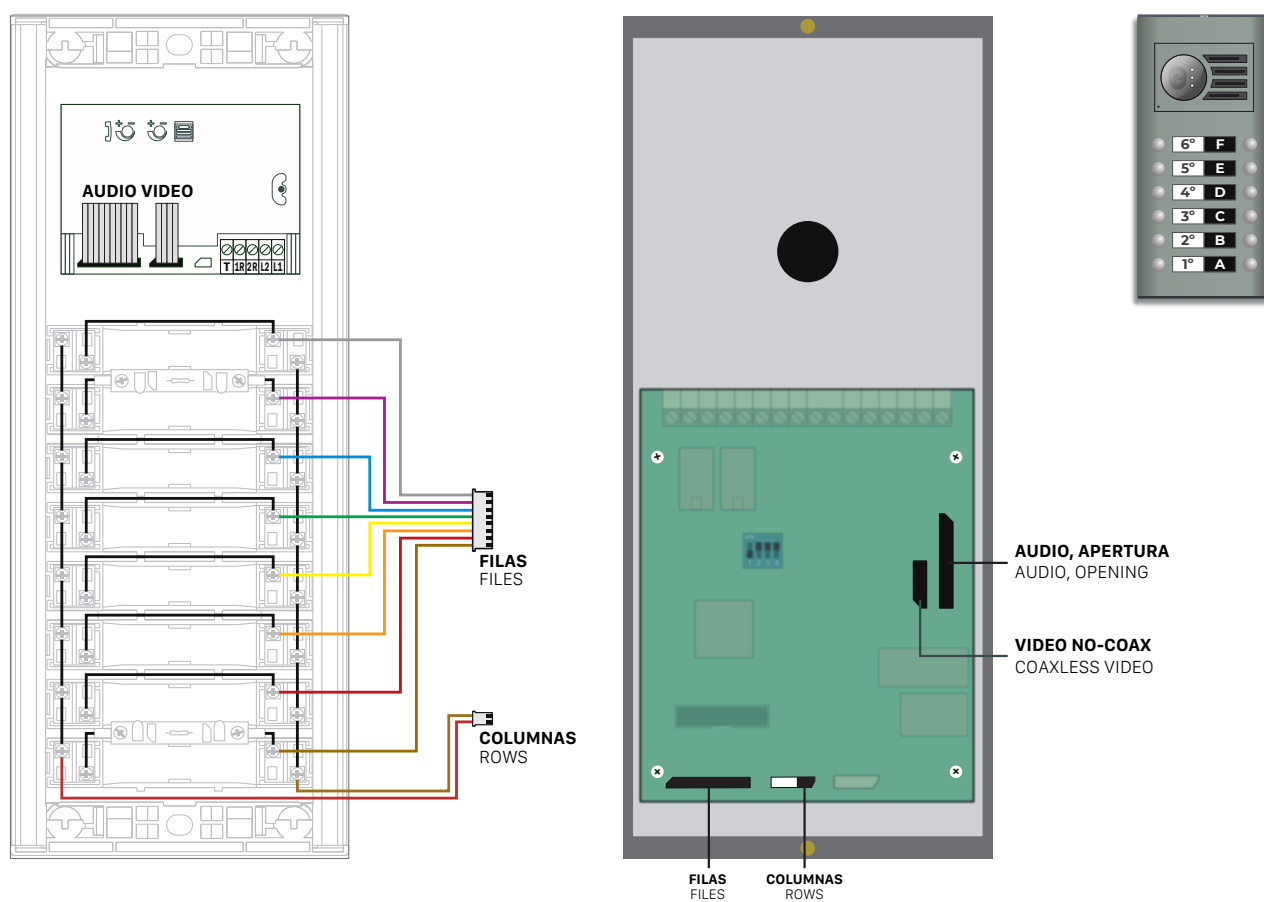

## Ejemplos de instalación Installation examples

### AUDIO 3H AUDIO 3W

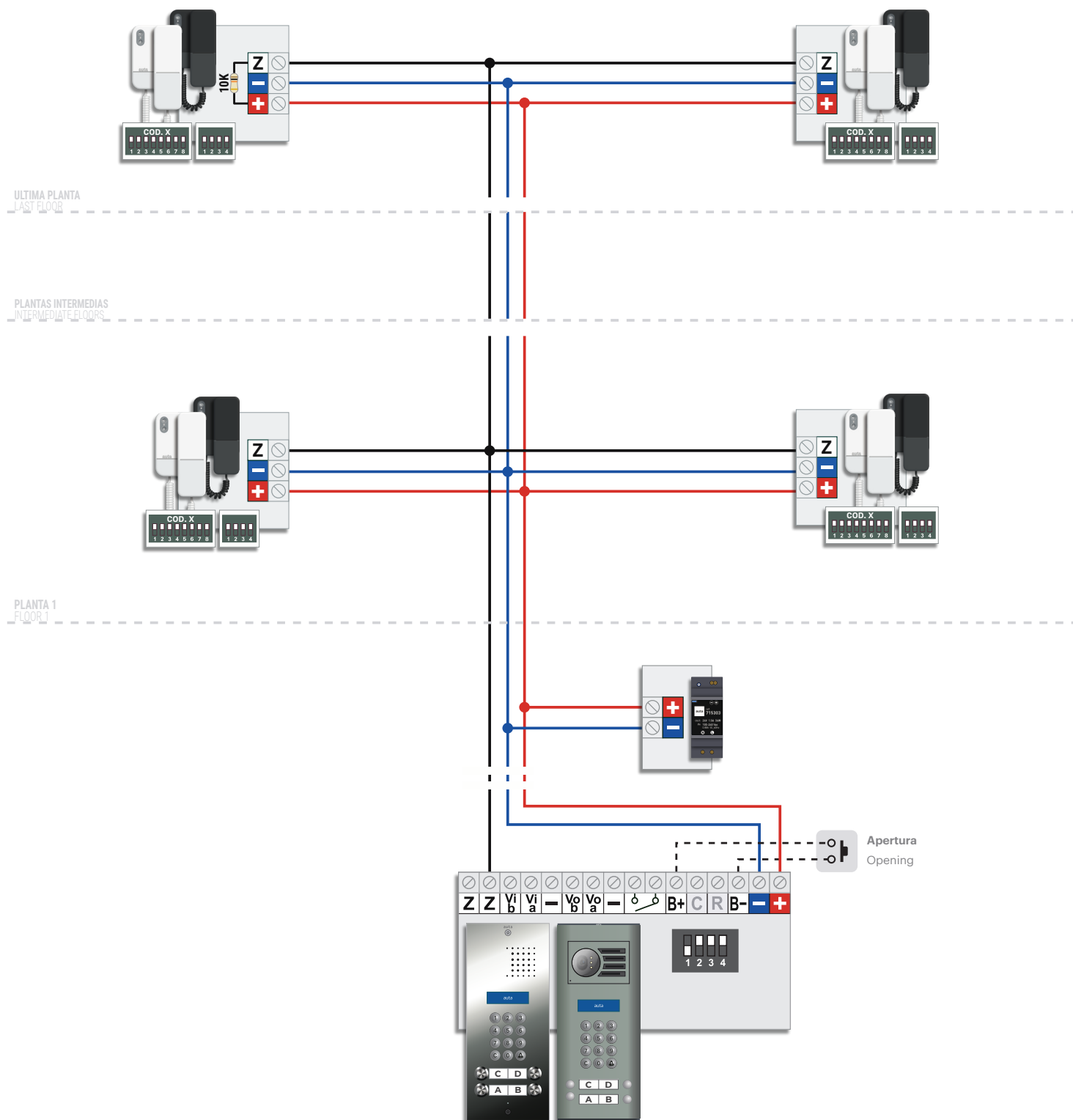

Manual de instalación AUDIO VISUALTECH 3H  
 Installation manual AUDIO VISUALTECH 3W

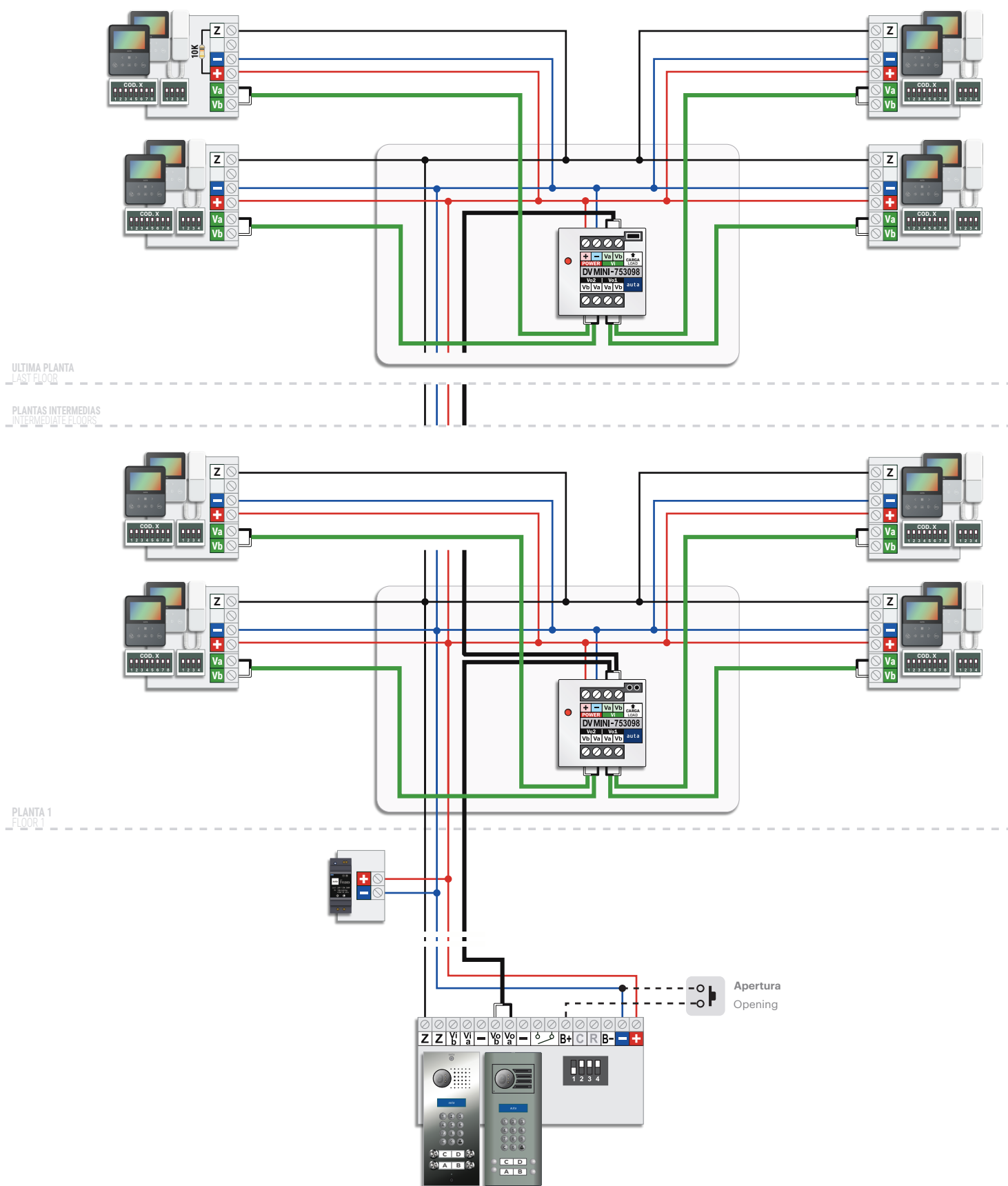
**VIDEO 5H VIDEO 5W**

Manual de instalación VIDEO VISUALTECH 5H  
 Installation manual VIDEO VISUALTECH 5W

## Ajustes Settings

Para cualquier modificación, en caso de un sistema pulsadores, se necesitará conectar una placa teclado o un teclado MINI (730165).

To any modification, in case of push-buttons system, you'll need to connect a keyboard panel or a MINI keyboard (730165).



**C** Siguiente menú  
Next menu

**A** Validar\_Cambiar  
Validate\_Change

**CODIGO APERT. 1**  
101010

**Código de apertura 1 (101010) ( 0, desactivado)**  
**Código de apertura 2 (202020) ( 0, desactivado)**  
**Código de apertura 3 (303030) ( 0, desactivado)**  
**Código de apertura 4 (404040) ( 0, desactivado)**

Como activar apertura



Opening code 1 (101010) ( 0, disabled)  
 Opening code 2 (202020) ( 0, disabled)  
 Opening code 3 (303030) ( 0, disabled)  
 Opening code 4 (404040) ( 0, disabled)

How to activate the opening



**TIEMPO APERT. 1**  
2 seg

**Tiempo de apertura 1 (2 seg) (apertura desde vivienda)**  
**Tiempo de apertura 2 (5 seg) (apertura desde pulsador B+ y B-)**

Opening time 1 (2 sec) (opening from flat)  
 Opening time 2 (5 sec) (opening from push-button B+ y B-)

**NUMERO DE PLACA**  
1

**Información del código de placa configurado en el switch binario**  
 Panel code information configured on the binary switch

**AUTOENCENDIDO** si

**La placa permite el auto-encendido desde viviendas, defecto SI**  
 The panel allows the self-starting from flats, default YES

**Pulsador CSJ:**  
0

**Seleccionaremos una posición de pulsador que efectuará una llamada directa a conserjería. En sistemas con placas de teclado + pulsadores será desde 1 a 12 (A\_B\_C\_D\_E\_F\_G\_H\_I\_J\_K\_L). En sistemas con placas de pulsador será desde 1 a 66 (plantilla de pulsadores, página 10).**

We will select a push button position that will make a direct call to the concierge. In systems with keyboard panel + push-buttons it will be from 1 to 12 (A\_B\_C\_D\_E\_F\_G\_H\_I\_J\_K\_L). In systems with push-button panels it will be from 1 to 66 (push button template, page 10).

**¿ Solo pulsadores ?**  
No  L  O

**Permite configurar sistemas de placas de pulsador (página 8).**

- \* También en esta pantalla si pulsamos 5 activaremos la tabla LARGA "L", página 7.
- \* También en pantalla si pulsamos 0 activaremos la planta CERO "O" (0A, 0B, ...).

Allows to configure systems with push-buttons panels (page 8).

- \* Also in this screen if we press 5 we will activate the LARGE table "L", page 7.
- \* Also in this screen if we press 0 we will activate the floor ZERO "O" (0A, 0B, ...).

**¿ Planta - Puerta ?**  
No

**Permite modificar el texto del display, en lugar de "Piso-Letra" el sistema mostrará el texto "Planta-Puerta."**

Allows to modify the text in the display, instead of show "Floor-Letter" the system will show the text ""Plant-Door".

**NUEVO COD ACCESO CONFIG:** 1

**NUEVO COD ACCESO CONFIG: 1** cambia el código de acceso al menú configuración.  
 NEW ACCESS CODE CONFIG: 1 changes the access code for the configuration menu.

## Configuración Configuration

Para cualquier modificación, en caso de un sistema pulsadores, se necesitará conectar una placa teclado o un teclado MINI (730165).

To any modification, in case of push-buttons system, you'll need to connect a keyboard panel or a MINI keyboard (730165).

### ► Ajustes predefinidos en fábrica Factory settings

|  | Función Function  | Fábrica Factory                |  |
|--|---|--------------------------------|--|
| <b>AUTO</b>                              | <b>Auto-encendido</b><br>Self-starting  | ✓                              | <b>FUNCIÓN SIEMPRE ACTIVA</b><br>FUNCTION ALWAYS ACTIVATED |
| <b>CCI</b>                               | <b>Llamada a conserjería</b><br>Call to switchboard                             | ✓                              |  |
| <b>TIEMPO APERT. 1</b><br>OPENING TIME 1 | <b>Tiempo de apertura desde vivienda</b><br>Opening time from flat              | <b>2 segundos</b><br>2 seconds |  |
| <b>TIEMPO APERT. 2</b><br>OPENING TIME 2 | <b>Tiempo de apertura desde pulsador B+</b><br>Opening time from push-button B+ | <b>5 segundos</b><br>5 seconds |  |

### ► Códigos en binario, página 11, asignados a cada vivienda (tabla ESTÁNDAR)

Codes in binary, page 11, assigned to every flat (STANDARD table).



|                                 |                            | VIVIENDAS FLATS |     |     |     |     |     |     |     |     |     |     |     |     |
|---------------------------------|----------------------------|-----------------|-----|-----|-----|-----|-----|-----|-----|-----|-----|-----|-----|-----|
|                                 |                            | A               | B   | C   | D   | E   | F   | G   | H   | I   | J   | K   | L   |     |
| P<br>L<br>A<br>N<br>T<br>A<br>S | 19°                        | 217             | 218 | 219 | 220 | 221 | 222 | 223 | 224 | 225 | 226 | 227 | 228 |     |
|                                 | 18°                        | 205             | 206 | 207 | 208 | 209 | 210 | 211 | 212 | 213 | 214 | 215 | 216 |     |
|                                 | 17°                        | 193             | 194 | 195 | 196 | 197 | 198 | 199 | 200 | 201 | 202 | 203 | 204 |     |
|                                 | 16°                        | 181             | 182 | 183 | 184 | 185 | 186 | 187 | 188 | 189 | 190 | 191 | 192 |     |
|                                 | 15°                        | 169             | 170 | 171 | 172 | 173 | 174 | 175 | 176 | 177 | 178 | 179 | 180 |     |
|                                 | 14°                        | 157             | 158 | 159 | 160 | 161 | 162 | 163 | 164 | 165 | 166 | 167 | 168 |     |
|                                 | 13°                        | 145             | 146 | 147 | 148 | 149 | 150 | 151 | 152 | 153 | 154 | 155 | 156 |     |
|                                 | 12°                        | 133             | 134 | 135 | 136 | 137 | 138 | 139 | 140 | 141 | 142 | 143 | 144 |     |
|                                 | 11°                        | 121             | 122 | 123 | 124 | 125 | 126 | 127 | 128 | 129 | 130 | 131 | 132 |     |
|                                 | 10°                        | 109             | 110 | 111 | 112 | 113 | 114 | 115 | 116 | 117 | 118 | 119 | 120 |     |
|                                 | F<br>L<br>O<br>O<br>R<br>S | 9°              | 97  | 98  | 99  | 100 | 101 | 102 | 103 | 104 | 105 | 106 | 107 | 108 |
|                                 |                            | 8°              | 85  | 86  | 87  | 88  | 89  | 90  | 91  | 92  | 93  | 94  | 95  | 96  |
| 7°                              |                            | 73              | 74  | 75  | 76  | 77  | 78  | 79  | 80  | 81  | 82  | 83  | 84  |     |
| 6°                              |                            | 61              | 62  | 63  | 64  | 65  | 66  | 67  | 68  | 69  | 70  | 71  | 72  |     |
| 5°                              |                            | 49              | 50  | 51  | 52  | 53  | 54  | 55  | 56  | 57  | 58  | 59  | 60  |     |
| 4°                              |                            | 37              | 38  | 39  | 40  | 41  | 42  | 43  | 44  | 45  | 46  | 47  | 48  |     |
| 3°                              |                            | 25              | 26  | 27  | 28  | 29  | 30  | 31  | 32  | 33  | 34  | 35  | 36  |     |
| 2°                              |                            | 13              | 14  | 15  | 16  | 17  | 18  | 19  | 20  | 21  | 22  | 23  | 24  |     |
| 1°                              | 1                          | 2               | 3   | 4   | 5   | 6   | 7   | 8   | 9   | 10  | 11  | 12  |     |     |



► **Códigos en binario, página 11, asignados a cada vivienda (tabla LARGA)**

Codes in binary, page 11, assigned to every flat (LARGE table).

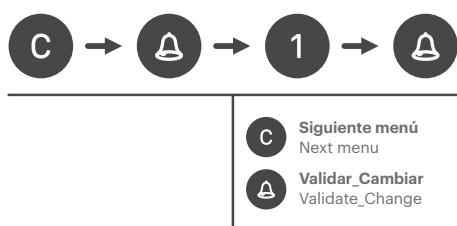

C Siguiente menú  
 Next menu  
 [Bell Icon] Validar\_Cambiar  
 Validate\_Change

¿ Solo pulsadores ?  
No

5

¿ Solo pulsadores ?  
No L

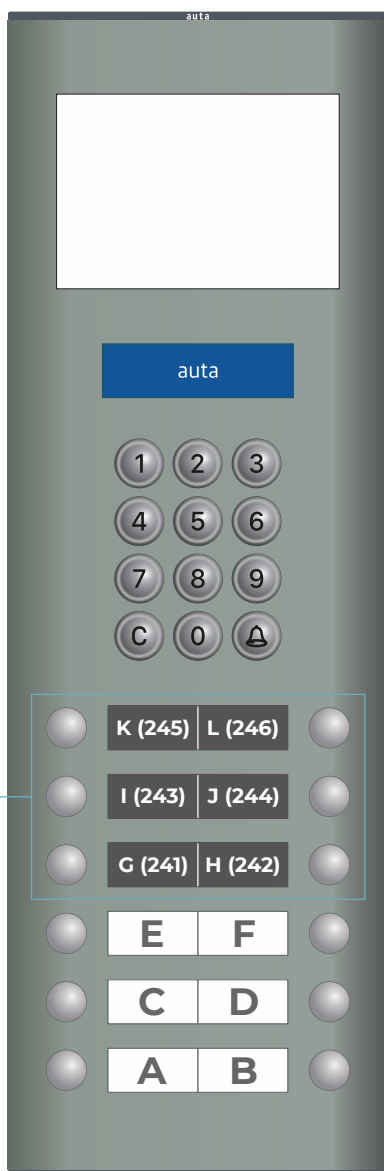

- Pulsadores que permiten, al pulsar, la llamada directa al código binario indicado (\*\*), página 11.

Push-buttons that allow, when press, the direct call to the indicated binary code (\*\*), page 11.

|                                 |     | VIVIENDAS FLATS |     |     |     |     |     |
|---------------------------------|-----|-----------------|-----|-----|-----|-----|-----|
|                                 |     | A               | B   | C   | D   | E   | F   |
| P<br>L<br>A<br>N<br>T<br>A<br>S | 39° | 229             | 230 | 231 | 232 | 233 | 234 |
|                                 | 38° | 223             | 224 | 225 | 226 | 227 | 228 |
|                                 | 37° | 217             | 218 | 219 | 220 | 221 | 222 |
|                                 | 36° | 211             | 212 | 213 | 214 | 215 | 216 |
|                                 | 35° | 205             | 206 | 207 | 208 | 209 | 210 |
|                                 | 34° | 199             | 200 | 201 | 202 | 203 | 204 |
|                                 | 33° | 193             | 194 | 195 | 196 | 197 | 198 |
|                                 | 32° | 187             | 188 | 189 | 190 | 191 | 192 |
|                                 | 31° | 181             | 182 | 183 | 184 | 185 | 186 |
|                                 | 30° | 175             | 176 | 177 | 178 | 179 | 180 |
|                                 | 29° | 169             | 170 | 171 | 172 | 173 | 174 |
|                                 | 28° | 163             | 164 | 165 | 166 | 167 | 168 |
|                                 | 27° | 157             | 158 | 159 | 160 | 161 | 162 |
|                                 | 26° | 151             | 152 | 153 | 154 | 155 | 156 |
|                                 | 25° | 145             | 146 | 147 | 148 | 149 | 150 |
|                                 | 24° | 139             | 140 | 141 | 142 | 143 | 144 |
|                                 | 23° | 133             | 134 | 135 | 136 | 137 | 138 |
|                                 | 22° | 127             | 128 | 129 | 130 | 131 | 132 |
|                                 | 21° | 121             | 122 | 123 | 124 | 125 | 126 |
|                                 | 20° | 115             | 116 | 117 | 118 | 119 | 120 |
| F<br>L<br>O<br>O<br>R<br>S      | 19° | 109             | 110 | 111 | 112 | 113 | 114 |
|                                 | 18° | 103             | 104 | 105 | 106 | 107 | 108 |
|                                 | 17° | 97              | 98  | 99  | 100 | 101 | 102 |
|                                 | 16° | 91              | 92  | 93  | 94  | 95  | 96  |
|                                 | 15° | 85              | 86  | 87  | 88  | 89  | 90  |
|                                 | 14° | 79              | 80  | 81  | 82  | 83  | 84  |
|                                 | 13° | 73              | 74  | 75  | 76  | 77  | 78  |
|                                 | 12° | 67              | 68  | 69  | 70  | 71  | 72  |
|                                 | 11° | 61              | 62  | 63  | 64  | 65  | 66  |
|                                 | 10° | 55              | 56  | 57  | 58  | 59  | 60  |
|                                 | 9°  | 49              | 50  | 51  | 52  | 53  | 54  |
|                                 | 8°  | 43              | 44  | 45  | 46  | 47  | 48  |
|                                 | 7°  | 37              | 38  | 39  | 40  | 41  | 42  |
|                                 | 6°  | 31              | 32  | 33  | 34  | 35  | 36  |
|                                 | 5°  | 25              | 26  | 27  | 28  | 29  | 30  |
|                                 | 4°  | 19              | 20  | 21  | 22  | 23  | 24  |
|                                 | 3°  | 13              | 14  | 15  | 16  | 17  | 18  |
|                                 | 2°  | 7               | 8   | 9   | 10  | 11  | 12  |
| 1°                              | 1   | 2               | 3   | 4   | 5   | 6   |     |

► **Códigos asignados a cada vivienda (SOLO PULSADORES)** Codes assigned to every flat (ONLY PUSH-BUTTONS).



**C** Siguiente menú  
Next menu

¿Solo pulsadores ?

No



¿Solo pulsadores ?

Si



¿Codificación de pulsadores ?

Si



NUM. PLANTAS?: 1



NUM. PLANTAS?: 1

NUM. LETRAS?: 1



PLANTA: 1

POSICIÓN?: 19



LETRA: A

POSICIÓN?: 1



Consultar CÓDIGO  
de TFNO/MON?



| Planta | Letra | COD |
|--------|-------|-----|
| 1      | A     | 1   |

Esta opción de configuración es muy versátil, el usuario puede elegir la posición que ocupan los pisos y las letras dentro de una placa o un conjunto de placas. Ofreciendo así combinaciones ilimitadas.

This configuration option is very versatile, the user can choose the position of the floors and letters inside one panel or a composition of panels. Offering unlimited combinations.

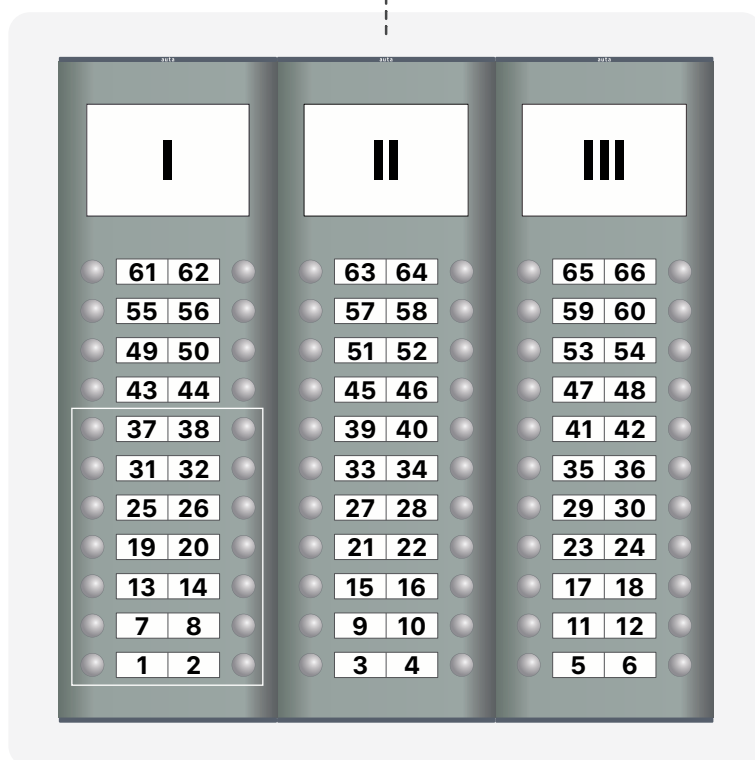
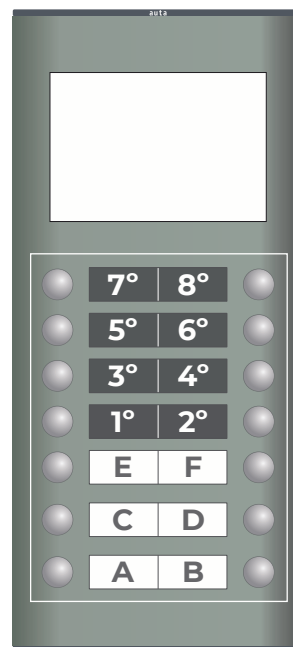

Cambiar  
Change



Salir  
Exit



COD → (binario, página 11)  
COD ⇔ (binary, page 11)

## Llamada a vivienda Call to flat

- **Llamada desde una placa de teclado + pulsadores** Call from a keypad + push-buttons panel



**Presionaremos el número del piso.**

**Presionaremos C para rectificar o cancelar una llamada en curso.**

We will press the number of the flat.

We will press C to rectify or cancel an ongoing call.

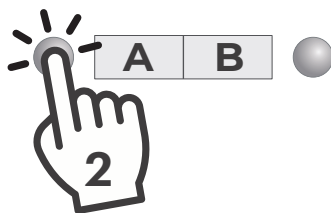

**Al pulsar escucharemos un sonido continuo de confirmación.**

**Todavía NO se estará efectuando la llamada a la vivienda.**

Pressing will hear a continuous confirmation sound.

The call to the flat will NOT be made yet.

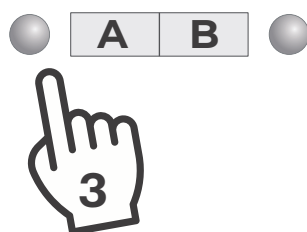

**Al dejar de pulsar se efectuará la llamada a la vivienda seleccionada.**

- **Si escuchamos un doble tono, el monitor\_teléfono estará sonando.**

- **Si no escuchamos nada, el monitor\_teléfono no estará respondiendo.**

When the button is released, the call to the selected flat will be made.

- If we hear a double tone, the monitor\_phone will be ringing.

- If we don't hear anything, the monitor\_phone will not be responding.

- **Llamada desde una placa de pulsadores** Call from a push-button panel

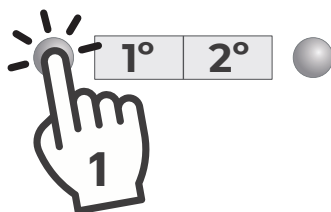

**Al pulsar escucharemos un sonido continuo de confirmación.**

**Todavía NO se estará efectuando la llamada a la vivienda.**

Pressing will hear a continuous confirmation sound.

The call to the flat will NOT be made yet.



**Al pulsar escucharemos un sonido continuo de confirmación.**

**Todavía NO se estará efectuando la llamada a la vivienda.**

Pressing will hear a continuous confirmation sound.

The call to the flat will NOT be made yet.

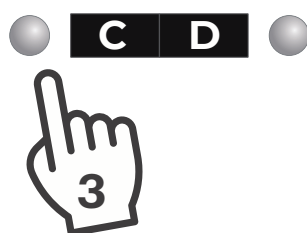

**Al dejar de pulsar se efectuará la llamada a la vivienda seleccionada.**

- **Si escuchamos un doble tono, el monitor\_teléfono estará sonando.**

- **Si no escuchamos nada, el monitor\_teléfono no estará respondiendo.**

When the button is released, the call to the selected flat will be made.

- If we hear a double tone, the monitor\_phone will be ringing.

- If we don't hear anything, the monitor\_phone will not be responding.

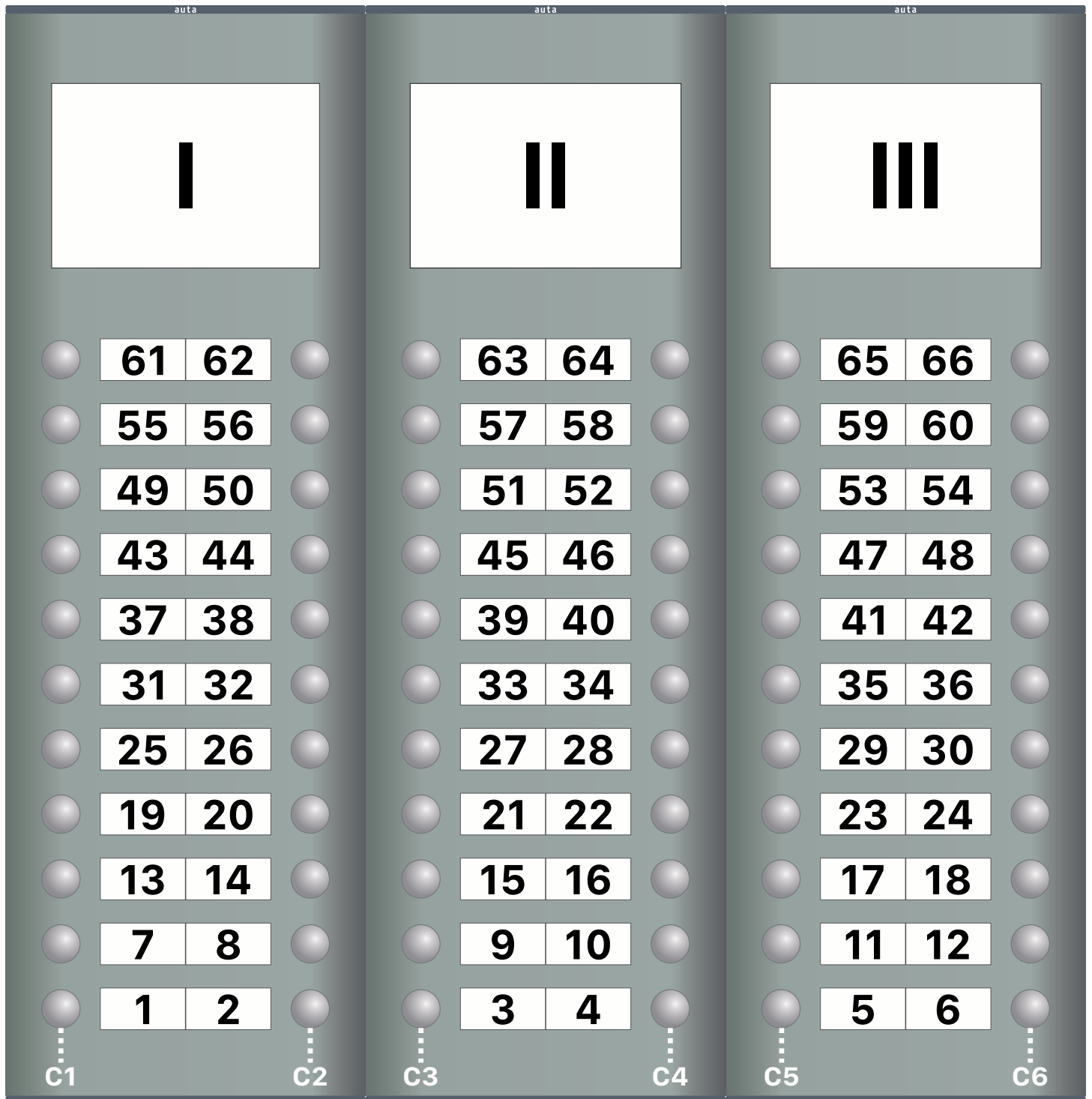
**Códigos que genera cada pulsador** Codes that generates every push-button.



## SECCIONES RECOMENDADAS RECOMMENDED SECTIONS

### ► Sistema, AUDIO VISUALTECH 3H System, VISUALTECH AUDIO 3W

| SECCIONES<br>WIRING SECTIONS   | HASTA 100m<br>UP TO 100m |
|--|--------------------------|
| + - Z  | 0.22mm AWG22             |
| EL CABLEADO NO DEBE PASAR CERCA DE LA LINEA ELÉCTRICA<br>WIRING MUST NOT BE RUN CLOSE TO THE ELECTRICAL LINE |                          |

|                            | CAT 5/6/FTP | AUTA        |
|----------------------------|-------------|-------------|
| par NARANJA<br>ORANGE pair |             | +           |
| par VERDE<br>GREEN pair    |             | -           |
| par AZUL<br>BLUE pair      |             | -           |
| par MARRÓN<br>BROWN pair   |             | Z           |
| 100% COBRE                 |             | 100% COPPER |

### ► Sistema, VIDEO VISUALTECH 5W System, VISUALTECH VIDEO 5W

| SECCIONES<br>WIRING SECTIONS   | HASTA 100m<br>UP TO 100m |
|--|--------------------------|
| + - Z Va Vb  | 0.22mm AWG22             |
| EL CABLEADO NO DEBE PASAR CERCA DE LA LINEA ELÉCTRICA<br>WIRING MUST NOT BE RUN CLOSE TO THE ELECTRICAL LINE |                          |

|                                      | CAT 5/6/FTP | AUTA        |
|--------------------------------------|-------------|-------------|
| par NARANJA<br>ORANGE pair           |             | +           |
| par VERDE<br>GREEN pair              |             | -           |
| cable AZUL_BLANCO<br>BLUE_WHITE wire |             | Va          |
| cable AZUL<br>BLUE wire              |             | Vb          |
| par MARRÓN<br>BROWN pair             |             | Z           |
| 100% COBRE                           |             | 100% COPPER |

### ► Recomendación para reposiciones AUDIO\_VIDEO Recommendation for renovations AUDIO\_VIDEO

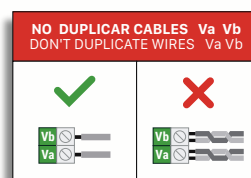
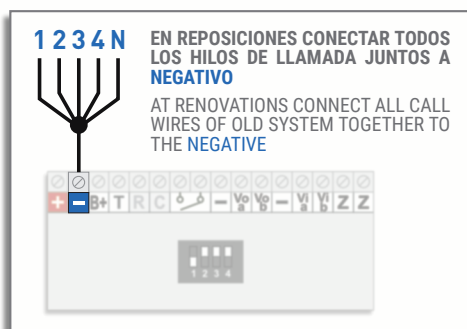

## CONEXIÓN DE ABREPUERTAS DOOR LOCK CONNECTION

