

auta

P&P

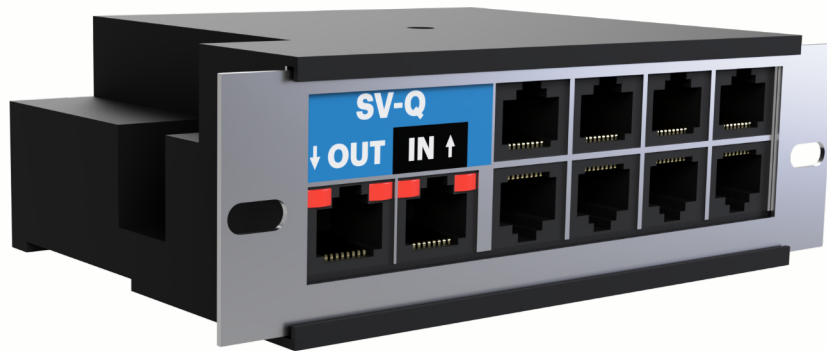

REF. 730161

ES Selector SVQ

EN SVQ selector

auta

Bringing people together

Descripción Description

Selector HUB de placas para sistema Auta P&P.

Cableado CAT 5_6 100% COBRE. Conexión mediante norma T-568B y conectores RJ-45.

Panels HUB selector for Auta P&P system.

Wiring CAT 5_6 100% COPPER. Connection by T-568B rule and connectors RJ-45.

Características Features

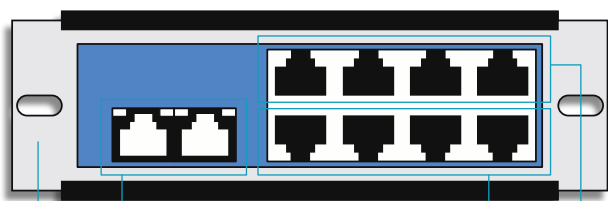

● Salidas para alimentación de placa (24 Vcc) Panel supply outputs (24 Vdc)

● Entradas de placa Panel inputs

● Salida _ Entrada (más de un selector) de línea - LEDS de estado Line Output (more than one selector) _ Input - Status LEDs

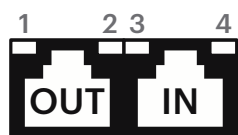

- | | | |
|---|---------------------------------|-----------------------|
| 1 | ROJO ENCENDIDO (entrada activa) | RED ON (active input) |
| 2 | ROJO ENCENDIDO (entrada activa) | RED ON (active input) |
| 3 | ROJO ENCENDIDO (entrada activa) | RED ON (active input) |
| 4 | ROJO ENCENDIDO (entrada activa) | RED ON (active input) |

● Soporte extraíble para montaje Removable mounting bracket

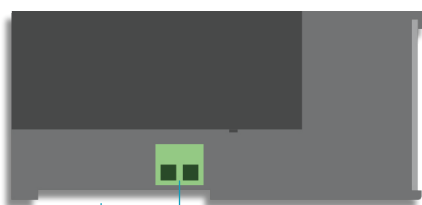

● Alimentación local (24 Vcc) Local supply (24 Vdc)

● Anclaje mediante carril DIN Mounting through DIN rail

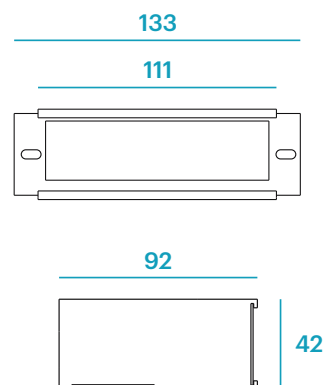

Montaje Mounting

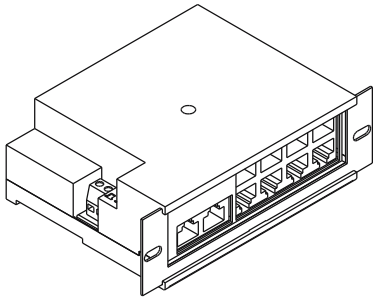

Rack 19"
19" rack

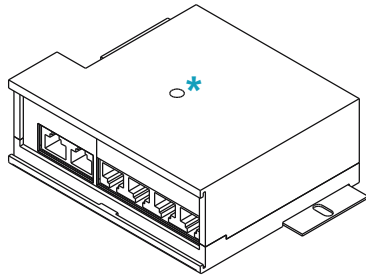

SUPERFICIE
(desatornillar levemente para cambiar el soporte)
SUFACE
(unscrew slightly to change the bracket)

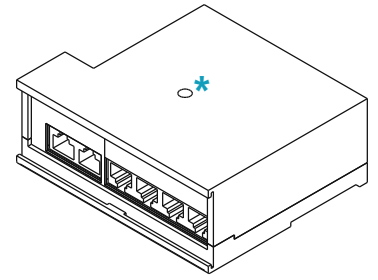

CARRIL DIN
(desatornillar levemente para extraer el soporte)
DIN RAIL
(unscrew slightly to remove the bracket)

Conexión Connection

	CAT 5/6/FTP	AUTA						
par NARANJA ORANGE pair		+	<p>T-568B</p>					
par VERDE GREEN pair		-						
cable AZUL_BLANCO BLUE_WHITE wire		Va						
cable AZUL BLUE wire		Vb						
cable MARRÓN_BLANCO BROWN_WHITE wire								
cable MARRÓN BROWN wire		D						
100% COBRE 100% COPPER								
T-568B								





Instalación Installation

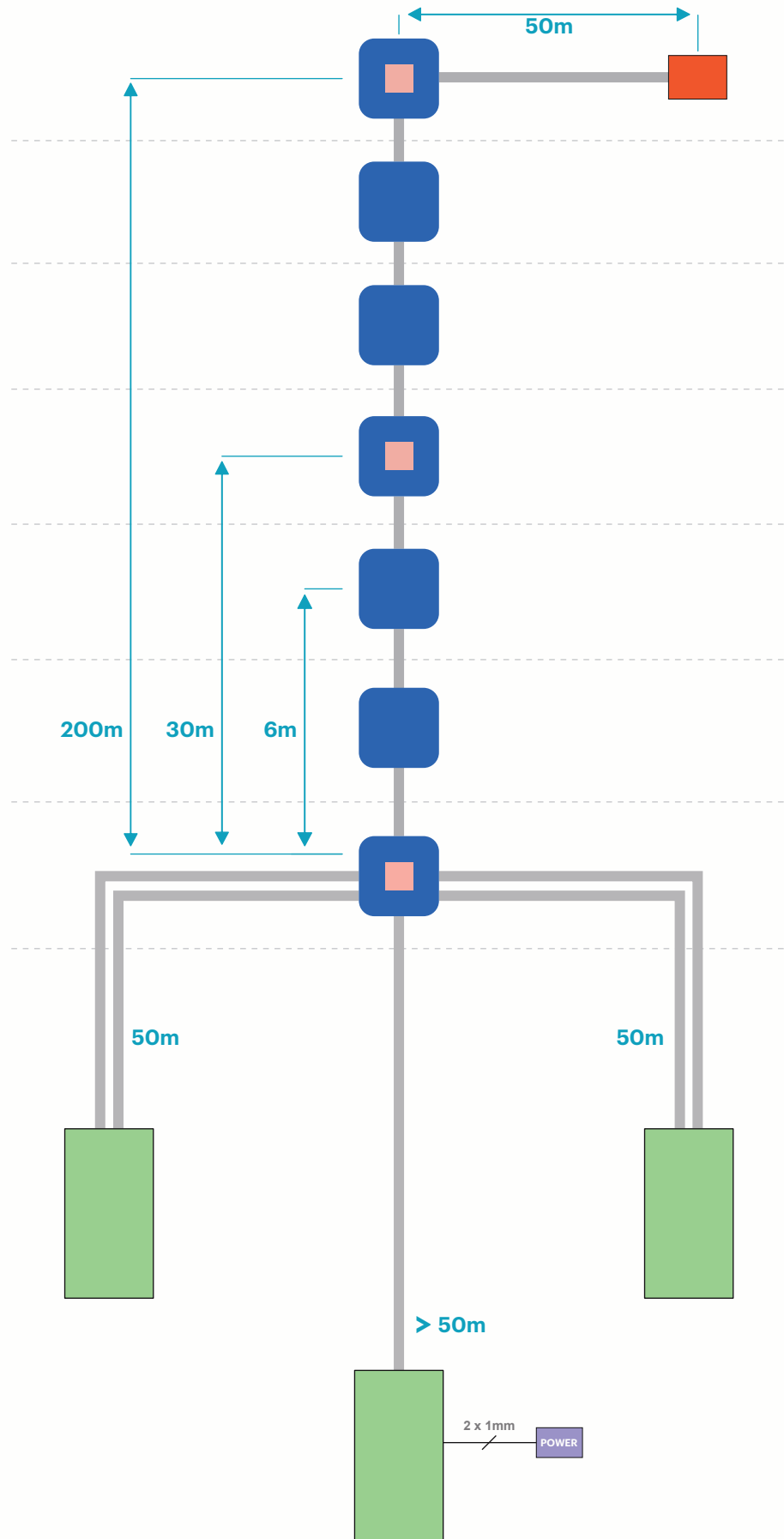

Manual de instalación P&P _ P&P ISO
Installation manual P&P _ ISO P&P

Distancias estándar Standard distances



-  **CELDA HUB CON ALIMENTADOR**
CELL HUB WITH P.S.U.
-  **CELDA HUB SIN ALIMENTADOR**
CELL HUB WITHOUT P.S.U.
-  **MONITOR**
MONITOR
-  **PLACA**
PANEL
-  **CAT 5_6_FTE 100% COPPER**