

# auta

## ANALOG



REF. 700505

- ES** Teléfono **COMPACT, UNIVERSAL**
- EN** COMPACT telephone, UNIVERSAL
- PT** Telefone **COMPACT, UNIVERSAL**
- FR** Téléphone COMPACT, UNIVERSEL

auta

Bringing people together

## Descripción Description

Teléfono analógico UNIVERSAL. Permite ser instalado en cualquier sistema analógico 4 + N. Incorpora dos pulsadores auxiliares que permiten la gestión de maniobras externas.

UNIVERSAL analog telephone. It can be installed in any 4 + N analogical system. It incorporates two auxiliary push-buttons that allows the management of external functions.

## Características Features

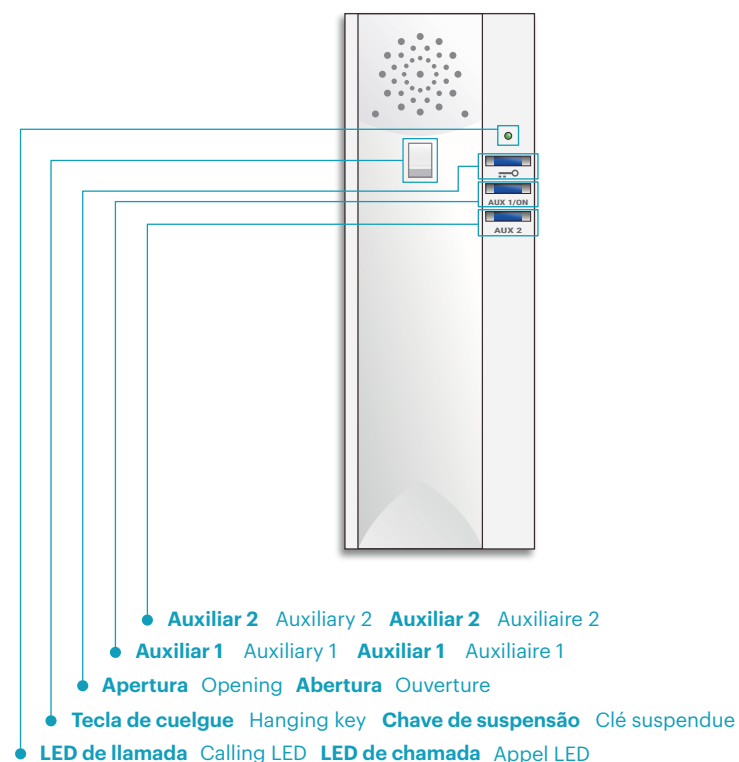

## Descrição Description

Telefone analógico UNIVERSAL. Pode ser instalado em qualquer sistema analógico 4 + N. Incorpora dois botões auxiliares que permitem o gerenciamento de manobras externas.

Téléphone analogique UNIVERSEL. Il peut être installé dans n'importe quel système analogique 4 + N. Il intègre deux boutons auxiliaires qui permettent la gestion des manœuvres externes.

## Características Características

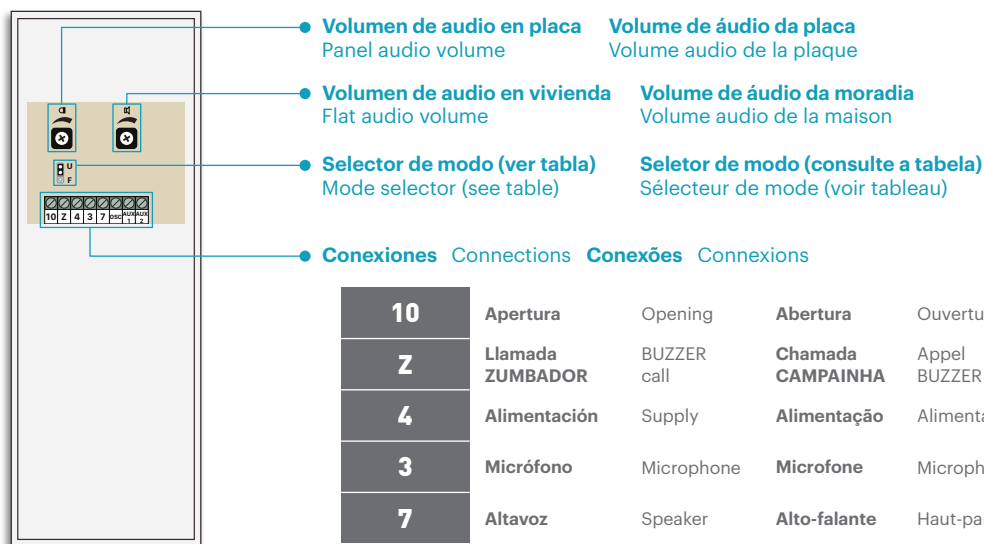
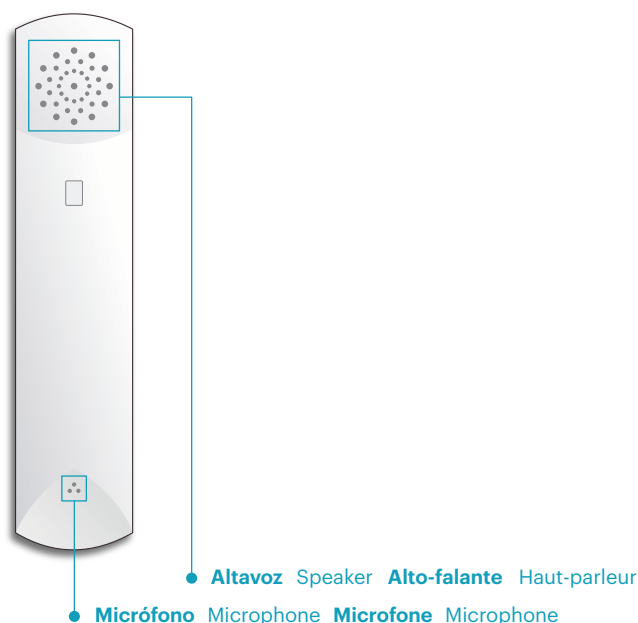

217

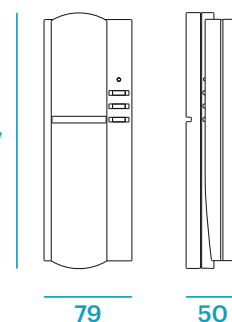

<b>10</b>	<b>Apertura</b>	Opening	<b>Abertura</b>	Ouverture
<b>Z</b>	<b>Llamada ZUMBADOR</b>	BUZZER call	<b>Chamada CAMPAINHA</b>	Appel BUZZER
<b>4</b>	<b>Alimentación</b>	Supply	<b>Alimentação</b>	Alimentation
<b>3</b>	<b>Micrófono</b>	Microphone	<b>Microfone</b>	Microphone
<b>7</b>	<b>Altavoz</b>	Speaker	<b>Alto-falante</b>	Haut-parleur
<b>OSC</b>	<b>Llamada ELECTRÓNICA</b>	ELECTRONIC call	<b>Chamada ELETRÓNICA</b>	Appel ÉLECTRONIQUE
<b>AUX1</b>	<b>+9 Vcc</b>	+9 Vdc	<b>+9 Vcc</b>	+9 Vcc
<b>AUX2</b>	<b>+9 Vcc</b>	+9 Vdc	<b>+9 Vcc</b>	+9 Vcc











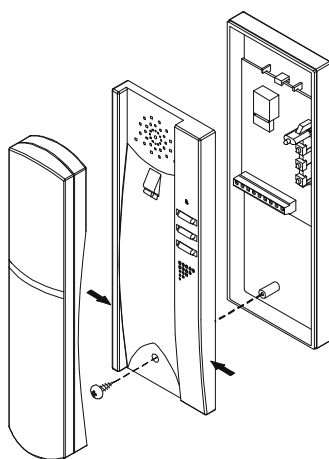



Tabla 1 Table 1

Tabela 1 Tableau 1

						
<b>AUTA COMPACT</b>	10	Z	4	3	7	OSC
<b>ACET</b>	5	9	2	10	7	
<b>AIPHONE</b>	4	B	3	2	1	
<b>ALCAD TUN-001</b>	1	6	2	3	4	5
<b>AMPLIVOX</b>	Z	1	0	R	T	
<b>ARFE</b>	1	V	2	1	3	
<b>ATEA</b>	2	5	3	4	1	
<b>AUTA TF-89 (5 / 29)</b>	10	12	4	3	7	
<b>AUTA TF-92 (5 / 63)</b>	10		4	3	7	12
<b>AUTA DECOR</b>	10		4	3	7	12
<b>AUTELCO</b>	P5	2	1	A	B	
<b>BOGEN</b>	T	6	3	1	2	
<b>B.P.T.</b>	2	3	4	1	5	
<b>CENTRAMATIC</b>	4	5	1	2	3	
<b>CITESA</b>	1	B	C	4	3	
<b>CITOFONIX</b>	3	5	2	1	4	
<b>CITOVOX</b>	5	T	9	10	7	
<b>COMELIT</b>	P1	1	4	3	2	
<b>COSESA - AMPER TLFNO</b>	D	E	C	A	B	
<b>COSESA - AMPER MICRO</b>	R	Z	+	A	B	
<b>ELBEX</b>		+	LOW	MIC	SPEC	
<b>ELVOX</b>	2	+	9	6	1	
<b>FARFISA</b>	5	6	3	1	2	
<b>FECLO</b>	F	E	C	A	B	
<b>FERMAX TF-1Z</b>	1	4	3	2	6	
<b>FERMAX REKTO 4</b>	P	E	C	A	B	
<b>FERMAX GÓNDOLA</b>	4	V-5	3	1	2	
<b>FERMAX CITYMAX_LOFT</b>	1		3	2	6	4
<b>FRINGE</b>	2	4	1	3	6	
<b>GAME - HIRSCHMAN</b>	P	Z	3	2	1	
<b>GIRO</b>	2	4	1	3	6	
<b>GOLMAR</b>	C2	7	3	5	10	0
<b>GOLMAR</b>	X	N	A	M	S	
<b>GOLMAR</b>	11	12	3	5	4	
<b>GOLMAT T-600</b>	T	6	3	1	2	
<b>GOLMAR T-2800</b>	4	7	3	5	10	
<b>GUARDAL</b>	5	6	3 - 7	1	2	
<b>GUINAZ</b>	8	ZUM	5	6	7	PUL
<b>LASSER (AMPLIVOX)</b>	Z	1	0	R	T	



						
<b>AUTA COMPACT</b>	10	Z	4	3	7	OSC
<b>LT TERRANEO</b>	T1	6	3	1	2	
<b>MICROVOX</b>	3	5	2	1	4	
<b>MIGLIAVACCA</b>	A	7	5 - 6	3	1	
<b>NAGUI</b>	8	7	2	6	4	
<b>OSTELVI</b>	9	7	6	2	1	
<b>PAGANI COMPACT - 71</b>	ABR.	3	0	1	2	
<b>PHONE</b>	5	2	4	1	3	
<b>PORMAT</b>	4	V	2	3	1	
<b>PORMAT 6H</b>	4	V	2 - 5	3	1	
<b>PUYOLA</b>	Z	LL	M	T	U	
<b>RIPOLLES</b>	3	4	8	1	2	
<b>RUMBO</b>	2	4	1	3	6	
<b>SAFNAT</b>	4	V	2	1	3	
<b>SELTI</b>	5	6	3	1	2	
<b>SIEDLE HT-611-01</b>	1	7	9 / C	2	11	
<b>SIEMENS</b>	8 - 7	10	7 - 6	9	4	
<b>SINGLE</b>	2	4	3	1	5	
<b>SPRINT</b>	2	6	3	* / *	2	
<b>TAGRA</b>	8	4	6	2	1	
<b>T Y E</b>	8	4	6	2	7	
<b>TECNIPHONE</b>	4	V	3	1	2	
<b>TEGUI - GL</b>	3	1	2	4	5	
<b>TEGUI - HORIZON N</b>	3	1	2	4	5	
<b>TEGUI - HORIZON E</b>	3		2	4	5	1
<b>TEGUI T - 200</b>	3		2	4	5	1
<b>TELEVES</b>	4	T	3	2	1	
<b>TESLA DDZ 8S</b>	1	4	3	2	6	
<b>TESLA DDZ 93</b>	Z	4	3	2	6	
<b>TRANSVOX</b>	10	12	4	3	1	
<b>TRANSIFON</b>	1	4	6	5	7	
<b>TUNE</b>	8	4	6	2	1	
<b>URMET</b>	9	7	6	2	1	
<b>URMET</b>	10	6	11	2	3	
<b>URMET</b>	10	7	11	2	12	
<b>URMET 1133</b>	9		6	2	1	CA
<b>VEMEL</b>	5	1	3	2	4	
<b>VIDEX</b>	5	6	7	1	2	
<b>YUS PHONE</b>	EL	B / PT	-	T	R	