

auta

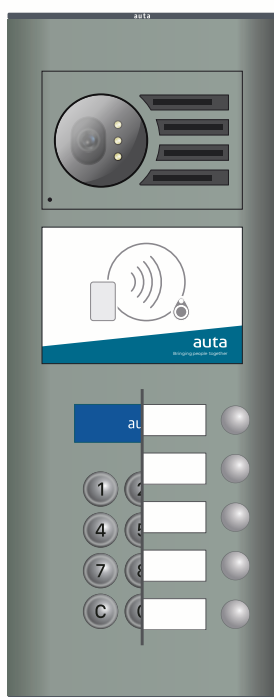

**AUTÓNOMO
STANDALONE**



REF: 507222



REF: 721150

ES LECTOR DE PROXIMIDAD 4K

EN PROXIMITY READER 4K

auta

Bringing people together

Características Features

ES

- : Lector de proximidad anti-vandálico
- : Funciona con 12-24V CC; 15-24V CA
- : Tecnología EM4002
- : 4000 usuarios
- : 1 Relé (2A/24V CC, 120V CA), 1 transistor (100mA)
- : 1 Botón de salida
- : Regulador de conmutación de la alimentación para una vida del producto más larga
- : Electrónica moldeada en resina
- : Dipswitch registrar tarjeta MASTER y BORRADO
- : Interruptor Tamper para seguridad antisabotaje
- : Consumo de corriente en Reposo: 30 mA
- Máximo: 100 mA
- : A prueba de polvo y resistente al agua (IP65)
- : Temperatura de funcionamiento: -25°C a +50°C

EN

- : Standalone vandal resistant proximity reader
- : Operates on 12-24V DC; 15-24V AC
- : EM4002 technology
- : 4000 users
- : 1 Relay (2A /24V DC,120V AC),1 transistor (100mA)
- : 1 EXIT Pushbutton
- : Power switching regulator for longer product life
- : Resin Potted electronics
- : Dip switch to register MASTER and SLAVE cards
- : Tamper switch for higher security
- : Current Consumption Standby: 30 mA
- Maximum: 100 mA
- : Dust proof and waterproof (I P65)
- : Operating Temperature: -25°C to +50°C

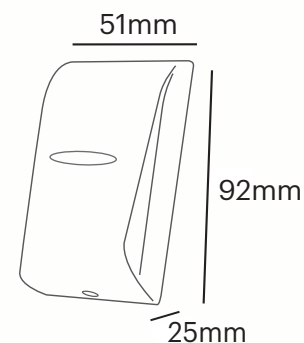

Montaje Mounting

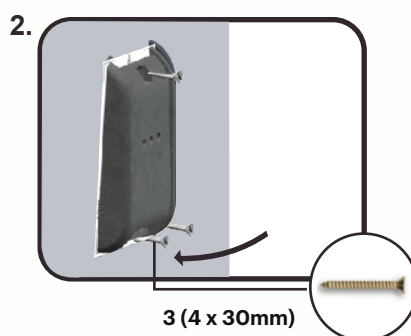
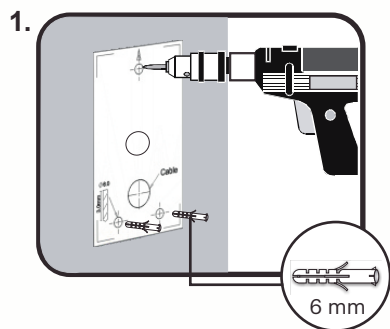

Cableado Wiring

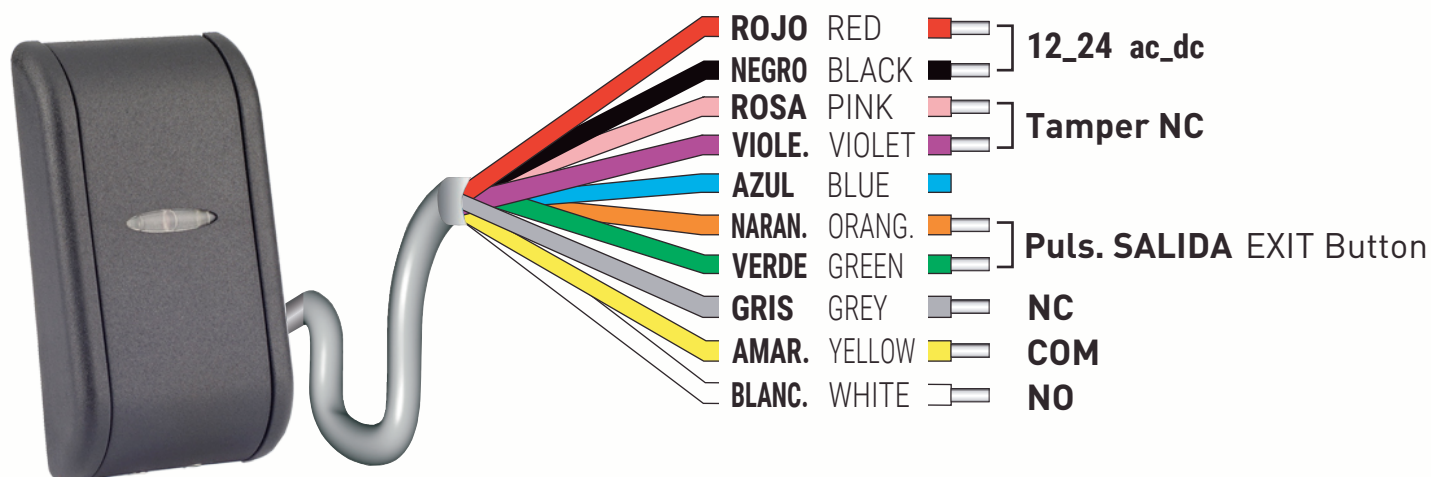

Cableado Wiring

CABLEADO PLACA COMPACT ANALOG. CON MÓDULO DE PROXIMIDAD 4K

ANALOG. COMPACT PANEL WITH 4K
PROXIMITY READER WIRING

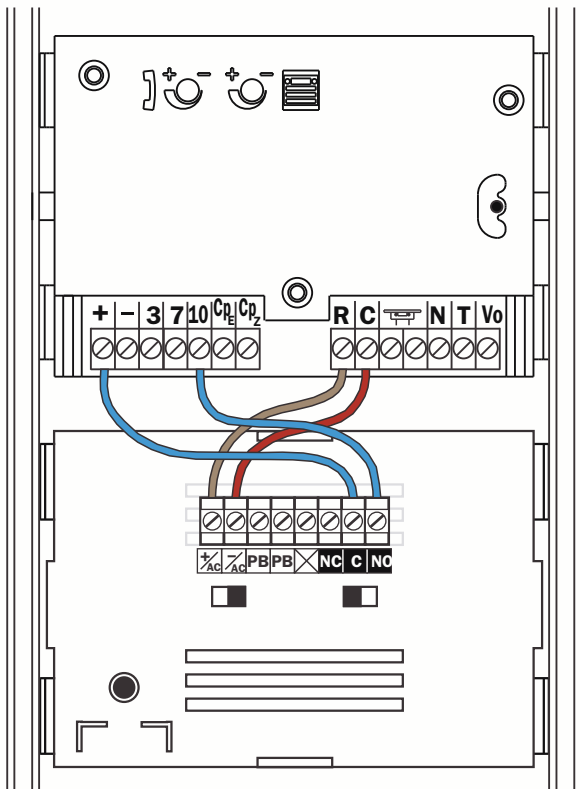

CABLEADO PLACA COMPACT DIGITAL CON MÓDULO DE PROXIMIDAD 4K

DIGITAL COMPACT PANEL WITH 4K
PROXIMITY READER WIRING

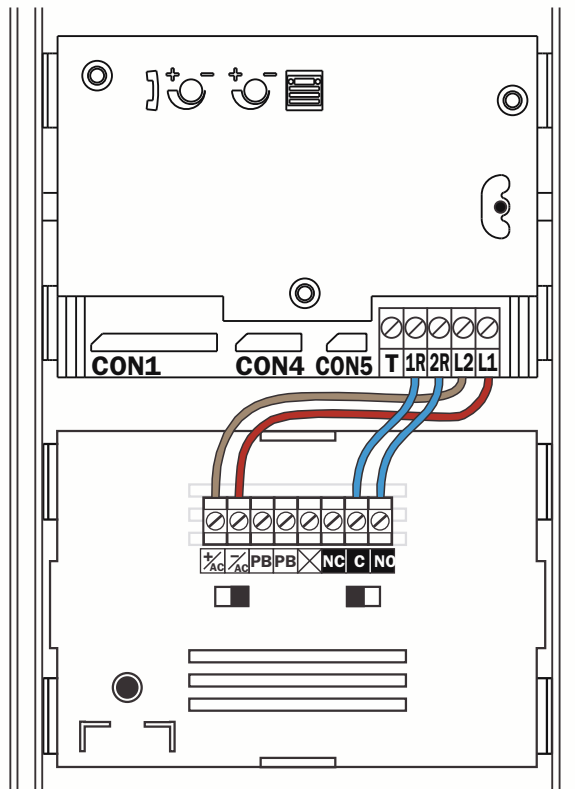

EJEMPLO DE CONEXIÓN INDEPENDIENTE DEL MÓDULO DE PROXIMIDAD 4K

EXAMPLE OF STANDALONE CONNECTION
OF THE 4K PROXIMITY READER

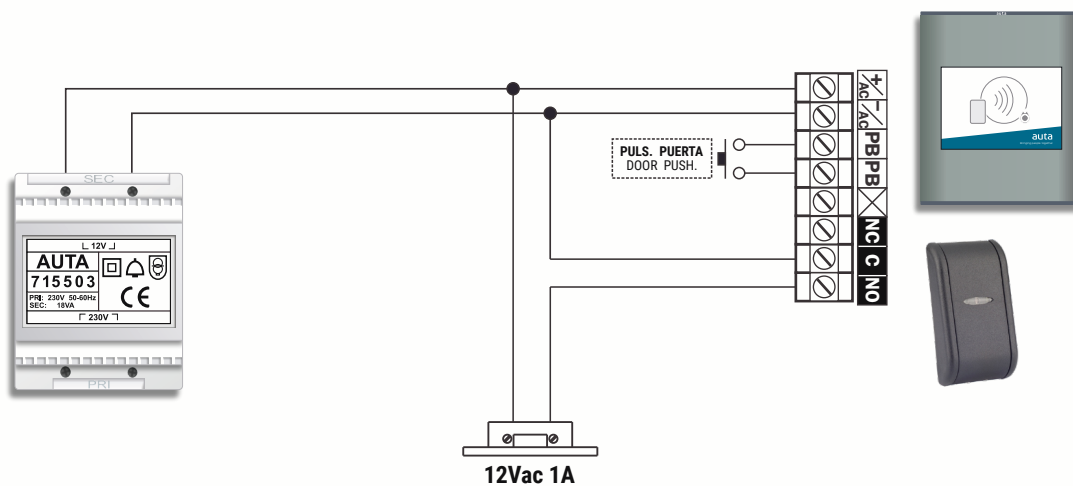

Registro de la tarjeta maestra y para suprimir

1. Apagar el lector
2. Poner el dipswitch nº 1 en posición ON.
3. Encender el lector. Los 3 LEDs parpadearán de manera continua.
4. Presentar la tarjeta maestra. Los leds rojo y amarillo parpadearán.
5. Presentar la tarjeta para suprimir. El led rojo parpadeará.
6. Apagar el lector.
7. Poner de nuevo el dipswitch nº 1 en posición OFF.

Dip switch no.1

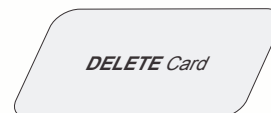
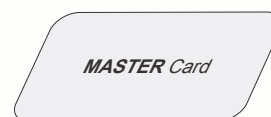
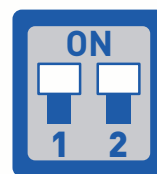

NOTA: El cambio de la tarjeta Maestra y Suprimir se puede hacer mediante el mismo procedimiento. Las viejas tarjetas Maestra y Suprimir quedarán automáticamente eliminadas.

Registro de usuarios

OPCIÓN 1

Para cada usuario se enrolarán 2 tarjetas: una tarjeta usuario y otra tarjeta duplicada (sombra). Esta última se guardará en un lugar seguro.

Si la tarjeta usuario ha sido robada o extraviada, la tarjeta duplicada (sombra) servirá para suprimir la tarjeta de usuario robada o extraviada de la memoria del lector.

OPCIÓN 2

Una sola tarjeta duplicada (sombra) se usará para enrolar y agrupar todos los usuarios.

Si la tarjeta de un usuario ha sido robada o extraviada no se podrá eliminar individualmente de la memoria del lector. Será necesario eliminar todos los usuarios y enrolarlos de nuevo.

ENTRADA	INDICACIÓN
1. Presentar la tarjeta maestra	<input checked="" type="radio"/> <input type="radio"/> <input type="radio"/> corto + tono largo
2. Presentar la tarjeta duplicada (sombra)	<input type="radio"/> <input checked="" type="radio"/> <input type="radio"/> corto + 3 tonos cortos
3. Presentar la tarjeta usuario ¹ o grupo tarjetas usuarios ²	<input type="radio"/> <input checked="" type="radio"/> <input type="radio"/> OK tono
4. Presentar la tarjeta maestra	<input type="radio"/> <input type="radio"/> <input type="radio"/> corto + 5 tonos cortos

Ejemplo: Registro de usuarios

OPCIÓN 1 Presentar la tarjeta maestra
Presentar la tarjeta duplicada (sombra)
Presentar la tarjeta usuario
Presentar la tarjeta maestra

OPCIÓN 2 Presentar la tarjeta maestra
Presentar la tarjeta duplicada (sombra)
Presentar las tarjetas usuarios
Presentar la tarjeta maestra

OPCIÓN 1

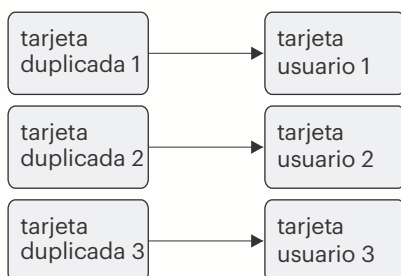

OPCIÓN 2

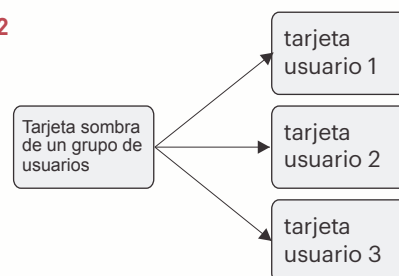

NOTA: Se pueden enrolar desde 1 a 4000 usuarios.

Enrolar un bloque de tarjetas usuario con numeración consecutiva









ENTRADA	INDICACIÓN
1. Presentar la tarjeta maestra	<input checked="" type="radio"/> <input type="radio"/> <input type="radio"/> corto + tono largo
2. Presentar la tarjeta duplicada (sombra)	<input type="radio"/> <input checked="" type="radio"/> <input type="radio"/> corto + 3 tonos cortos
3. Presentar la primera tarjeta del bloque de tarjetas 3 veces	<input type="radio"/> <input checked="" type="radio"/> <input type="radio"/> OK tono
4. Presentar la última tarjeta del bloque de tarjetas 3 veces	<input type="radio"/> <input checked="" type="radio"/> <input type="radio"/> OK tono
5. Presentar la tarjeta maestra	<input type="radio"/> <input type="radio"/> <input type="radio"/> corto + 5 tonos cortos

Ejemplo: Enrolamiento de 100 tarjetas

Presentar la tarjeta Maestra
Presentar la tarjeta duplicada
Presentar la primera tarjeta del bloque de tarjetas 3 veces (ex. 180 20001)
Presentar la última tarjeta del bloque de tarjetas 3 veces (ex. 180 20100)
Presentar la tarjeta Maestra

NOTA: Cada bloque de tarjetas usuario, **con numeración consecutiva**, no puede exceder las 100 tarjetas









Borrar un usuario (con la tarjeta usuario)

ENTRADA	INDICACIÓN
1. Presentar la tarjeta para suprimir	   corto + tono largo
2. Presentar la tarjeta usuario (o varias tarjetas usuario)	   OK tono
3. Presentar la tarjeta para suprimir	   corto + 5 tonos cortos

Ejemplo: **Suprimir dos usuarios**

Presentar la tarjeta para suprimir
Presentar la tarjeta del primer usuario
Presentar la tarjeta del segundo usuario
Presentar la tarjeta para suprimir









Borrar un usuario (con la tarjeta duplicada)

ENTRADA	INDICACIÓN
1. Presentar la tarjeta para suprimir	   corto + tono largo
2. Presentar la tarjeta duplicada (sombra) (o varias tarjetas)	   OK tono
3. Presentar la tarjeta para suprimir	   corto + 5 tonos cortos

Ejemplo: **Suprimir dos usuarios**









Presentar la tarjeta para suprimir
Presentar la tarjeta duplicada del primer usuario
Presentar la tarjeta duplicada del segundo usuario
Presentar la tarjeta para suprimir

Suprimir TODOS los usuarios

ENTRADA	INDICACIÓN
1. Presentar la tarjeta para suprimir	   corto + tono largo
2. Presentar la tarjeta maestra 3 veces	   OK tono
3. Presentar la tarjeta para suprimir	   Múltiples tonos + OK tono

NOTA: El borrado de los 4000 usuarios tarda unos 7 segundos aproximadamente

Configuración del tiempo de activación del relé







ENTRADA	INDICACIÓN
1. Presentar la tarjeta maestra 3 veces	   corto + tono largo
2. Presentar la tarjeta para suprimir X veces para X segundos (tiempo de apertura de puerta)	   OK tono
3. Presentar la tarjeta maestra	   corto + 5 tonos cortos

Ejemplo: **Dar 7 segundos de temporización**

Presentar la tarjeta maestra 3 veces
Presentar la tarjeta para suprimir 7 veces
Presentar la tarjeta maestra

NOTA: El tiempo del relé de puerta puede ser configurado entre 1 y 250 segundos

Configuración del relé de puerta en modo alternado (ON/OFF)

ENTRADA	INDICACIÓN
1. Presentar la tarjeta maestra 3 veces	   corto + tono largo
2. Presentar la tarjeta maestra	   corto + 5 tonos cortos

 LED ROJO

 LED VERDE

 LED VERDE TENUE

Enrol Master and Delete Card

1. Turn OFF the power supply
2. Push dip switch n° 1 in position ON.
3. Turn ON the power supply. All three LEDs will blink continuously.
4. Enter Master Card. Red and Yellow LED will blink.
5. Enter Delete Card. Red LED will blink.
6. Turn OFF the power supply.
7. Put again the dip switch n° 1 in position OFF.

Dip switch no.1

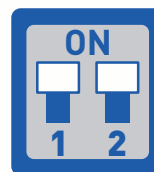

NOTE: Changing Master and Delete Card is done with the same procedure. Old Master and Delete Card are deleted automatically.

Enrol users

OPTION 1

For each User, 2 cards are being programmed: 1 User Card and 1 Shadow Card. The Shadow Card is kept on safe place.

If the User Card is lost or stolen, the Shadow Card will be used to delete the Card from the memory of the reader.

OPTION 2

One shadow card will be used to enrol and to group all users.

If the card of an user has been lost or stolen, not be able to be deleted individually from the memory of the reader. It will be necessary to delete all users and enrol them again.

INPUT	INDICATION
1. Present Master Card	R <input type="radio"/> <input type="radio"/> short + long beep
2. Present Shadow Card	<input type="radio"/> G <input type="radio"/> short + 3 short beeps
3. Present User Card (or multiple User cards)	<input type="radio"/> G <input type="radio"/> OK beep
4. Present Master Card	<input type="radio"/> <input type="radio"/> <input type="radio"/> short + 5 short beeps

Example: **Enrol users**

OPTION 1 Present Master Card
Present Shadow Card
Present User Card
Present Master Card

OPTION 2 Present Master Card
Present Shadow Card
Present User Card
Present Master Card

OPTION 1

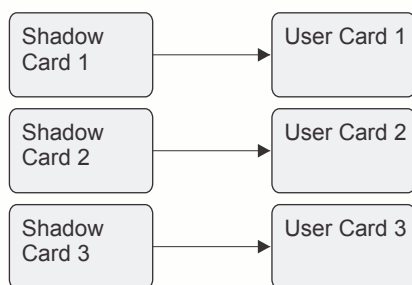

OPTION 2

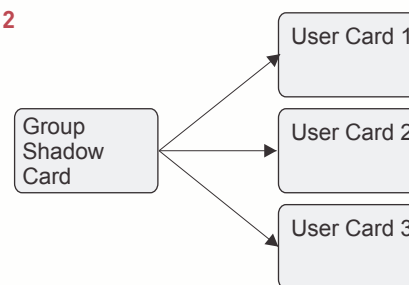

NOTE: From 1 to 4000 users can be enrolled

Enrol block of user cards with sequential id numbers

INPUT	INDICATION
1. Present Master Card	R <input type="radio"/> <input type="radio"/> short + long beep
2. Present Shadow Card	<input type="radio"/> G <input type="radio"/> short + 3 short beeps
3. Present the beginning card of the block 3 times	<input type="radio"/> G <input type="radio"/> OK beep
4. Present the ending card of the block 3 times	<input type="radio"/> G <input type="radio"/> OK beep
5. Present Master Card	<input type="radio"/> <input type="radio"/> <input type="radio"/> short + 5 short beeps

Example: **Enrol 100 cards**

Present Master Card
Present Shadow Card
Present the beginning card of the block 3 times (ex. **180 20001**)
Present the ending card of the block 3 times (ex. **180 20100**)
Present Master Card

NOTE: The block of User cards, **with sequential id numbers**, can be maximum **100 Cards**.



Delete a User (with the user card)

INPUT	INDICATION
1. Present Delete Card	short + long beep
2. Present User Card (or multiple User cards)	OK beep
3. Present Delete Card	short + 5 short beeps

Example: **Delete 2 Users**

Present Delete Card
Present First User Card
Present Second User Card
Present Delete Card

Delete a User (with the shadow user card)

INPUT	INDICATION
1. Present Delete Card	short + long beep
2. Present Shadow Card (or multiple Shadow cards)	OK beep
3. Present Delete Card	short + 5 short beeps

Example: **Delete Two Users**

Present Delete Card
Present First User Shadow Card
Present Second User Shadow Card
Present Delete Card

Delete ALL Users

INPUT	INDICATION
1. Present Delete Card	short + long beep
2. Present Master Card 3 times	OK beep
3. Present Delete Card	Multiple beeps+OK beep

NOTE: The deleting of the 4000 users has a time of 7 seconds approximately

Set Door Relay Time Activation

INPUT	INDICATION
1. Present Master Card 3 times	short + long beep
2. Present Delete Card X times for X seconds (Door Open Time)	OK beep
3. Present Master Card	short + 5 short beeps

Example: **Set 7 seconds relay time**

Present Master Card 3 times
Present Delete Card 7 times
Present Master Card

NOTE: Door relay time can be set in the range of 1 to 250 seconds.

Set Door Relay in Toggle (ON/OFF) Mode

INPUT	INDICATION
1. Present Master Card 3 times	short + long beep
2. Present Master Card	short + 5 short beeps

RED LED

GREEN LED

TENUOUS GREEN LED

