

auta

VISUALTECH



REF: 743101



REF: 743103



REF: 743131

ES KF-1 S1

EN KF-1 S1

auta

Bringing people together

Desmontaje del perfil Profile disassembly

PARA UNA MAYOR COMODIDAD REALIZAR EL PROCESO USANDO UNA SUPERFICIE DE APOYO.

FOR GREATER COMFORT, PERFORM THE PROCESS USING A SUPPORT SURFACE.

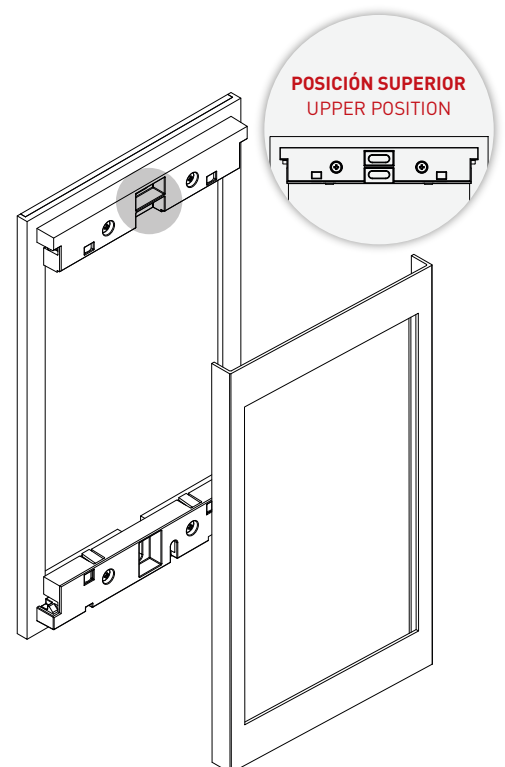
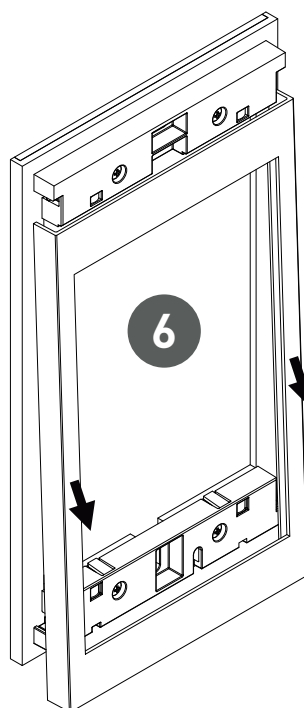
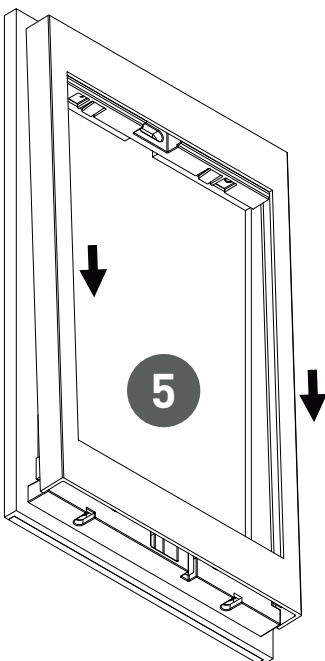
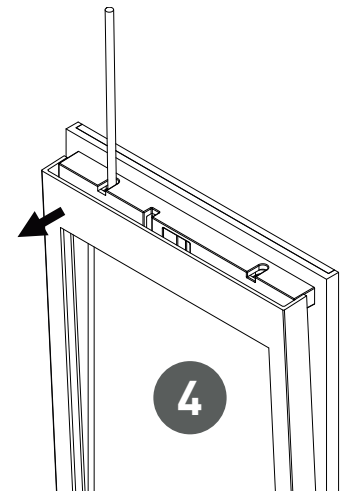
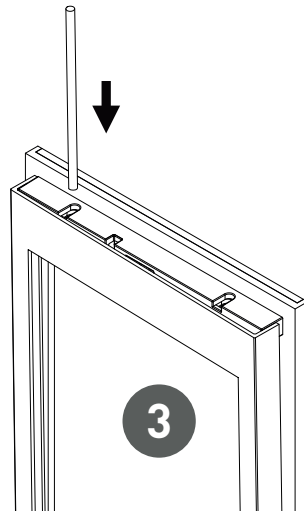
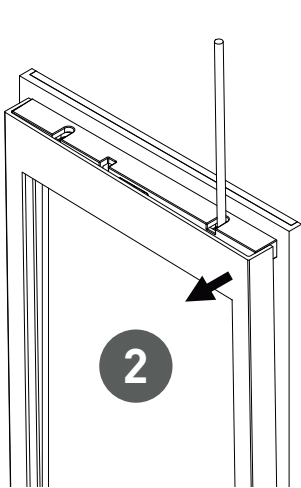
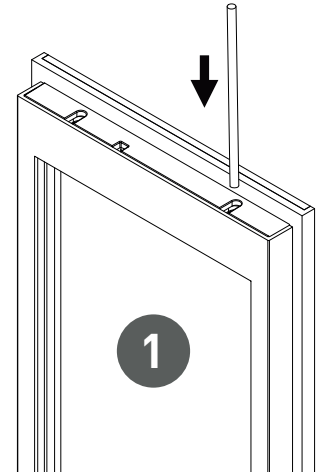
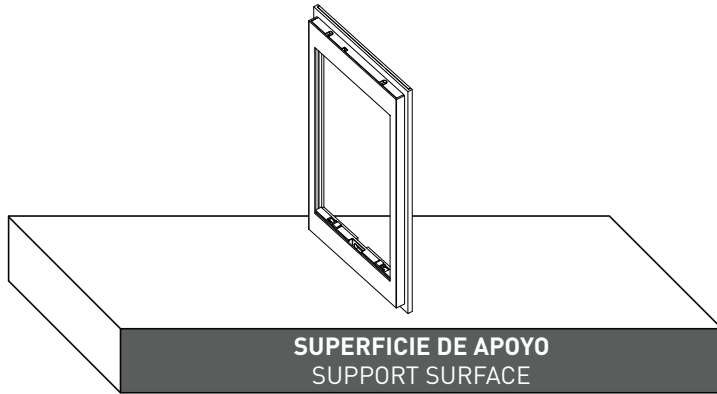

Elementos en el kit Elements in the kit



Colocar información en tarjetero Place information in card holder

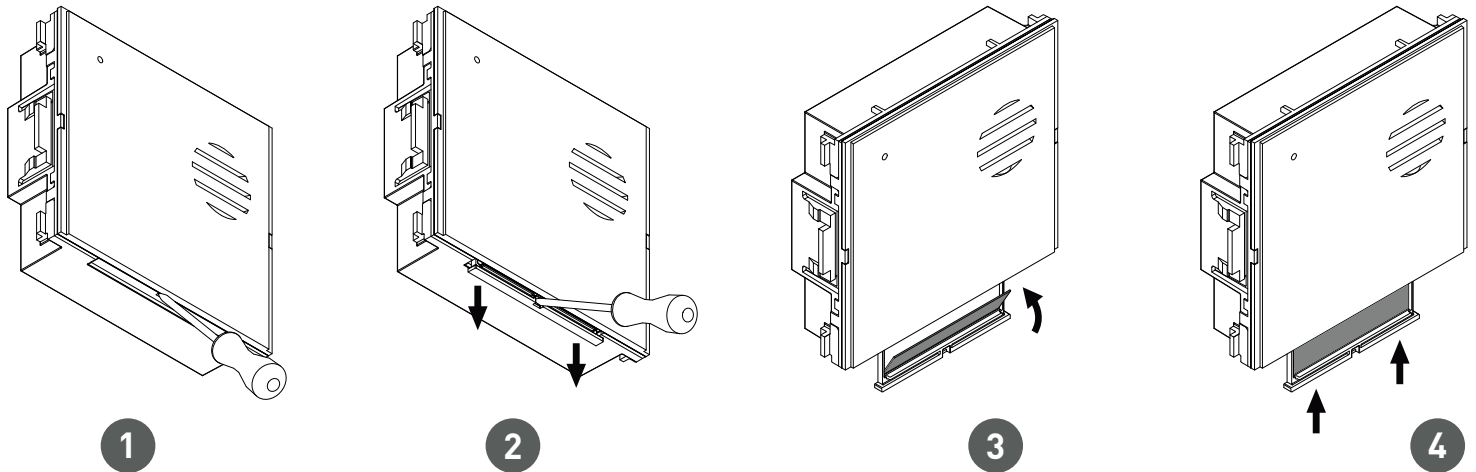

Descripción Description

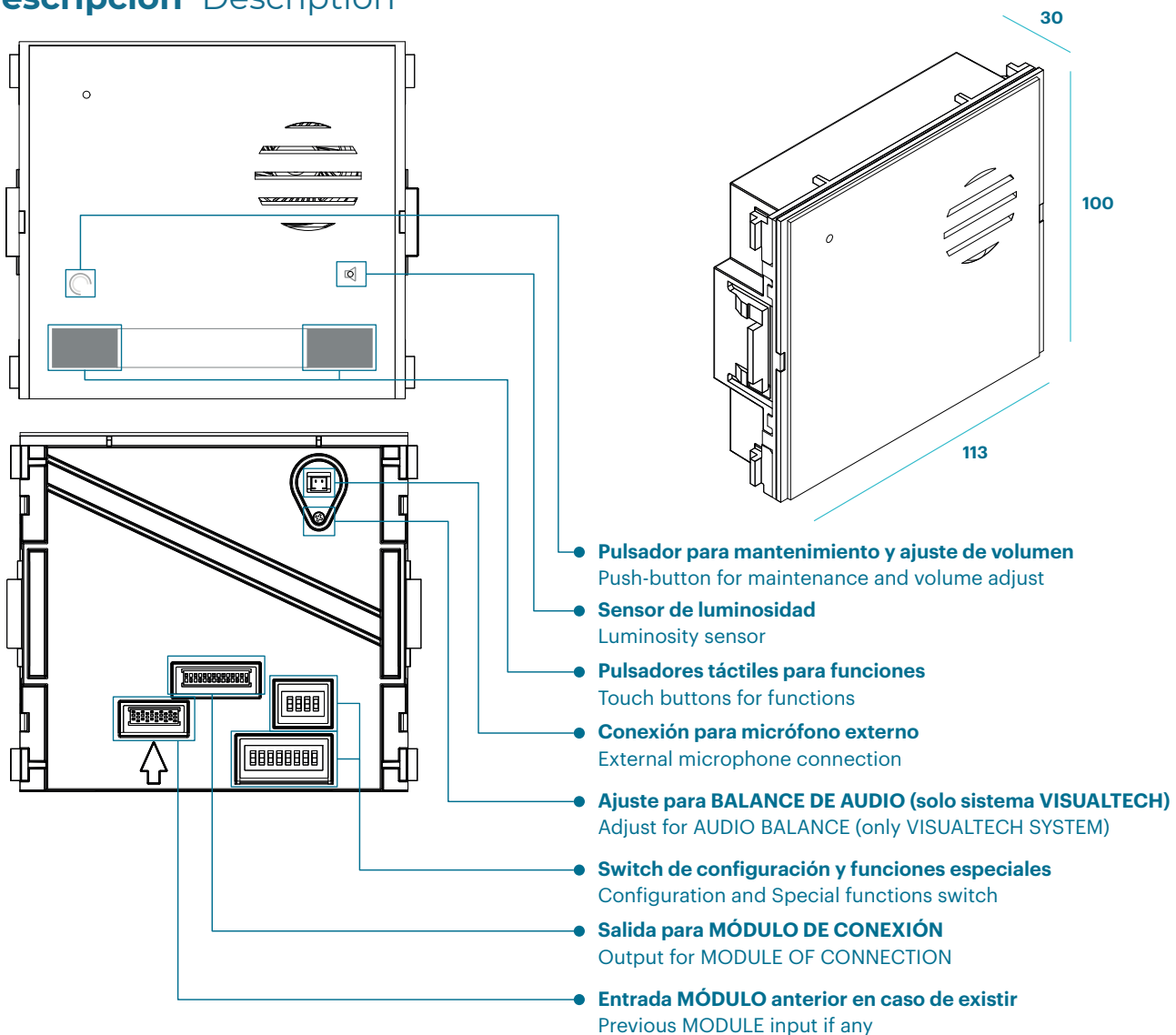

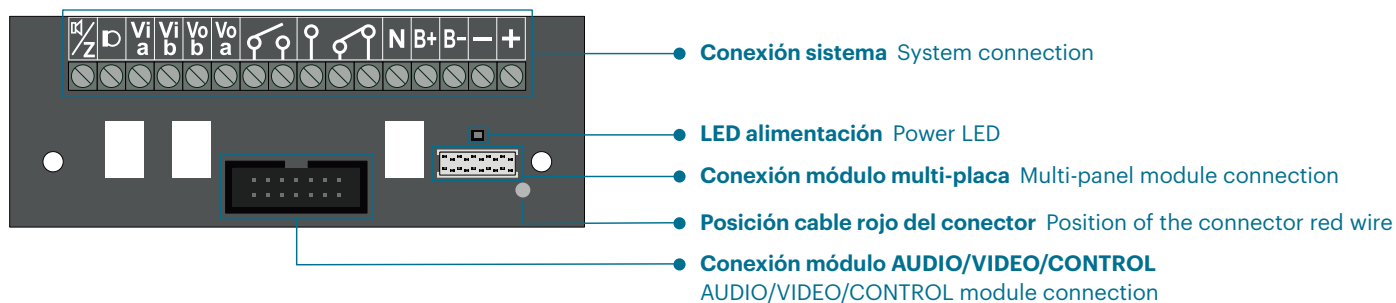

Z	Audio_Datos	Audio_Data
D	Micrófono (solo sistema digital)	Microphone (only digital system)
Vi_a	Video + (entrada)	Video + (in)
Vi_b	Video - (entrada)	Video - (in)
Vo_b	Video - (salida)	Video - (out)
Vo_a	Video + (salida)	Video + (out)
Relé libre de tensión N.A. _1A	Free tension N.O. _1A relay	
Relé libre de tensión N.A. - N.C. _1A	Free tension N.O. - N.C. _1A relay	
N	Salida NEGATIVO PARA MANIOBRAS (solo durante la llamada_conversación)	NEGATIVE out for managements (only during the call_conversation)
B+	Pulsador apertura (terminal 1)	Opening button (terminal 1)
B-	Pulsador apertura (terminal 2)	Opening button (terminal 2)
-	-24 Vcc	-24 Vdc
+	+24 Vcc	+24 Vdc

Instalación Installation

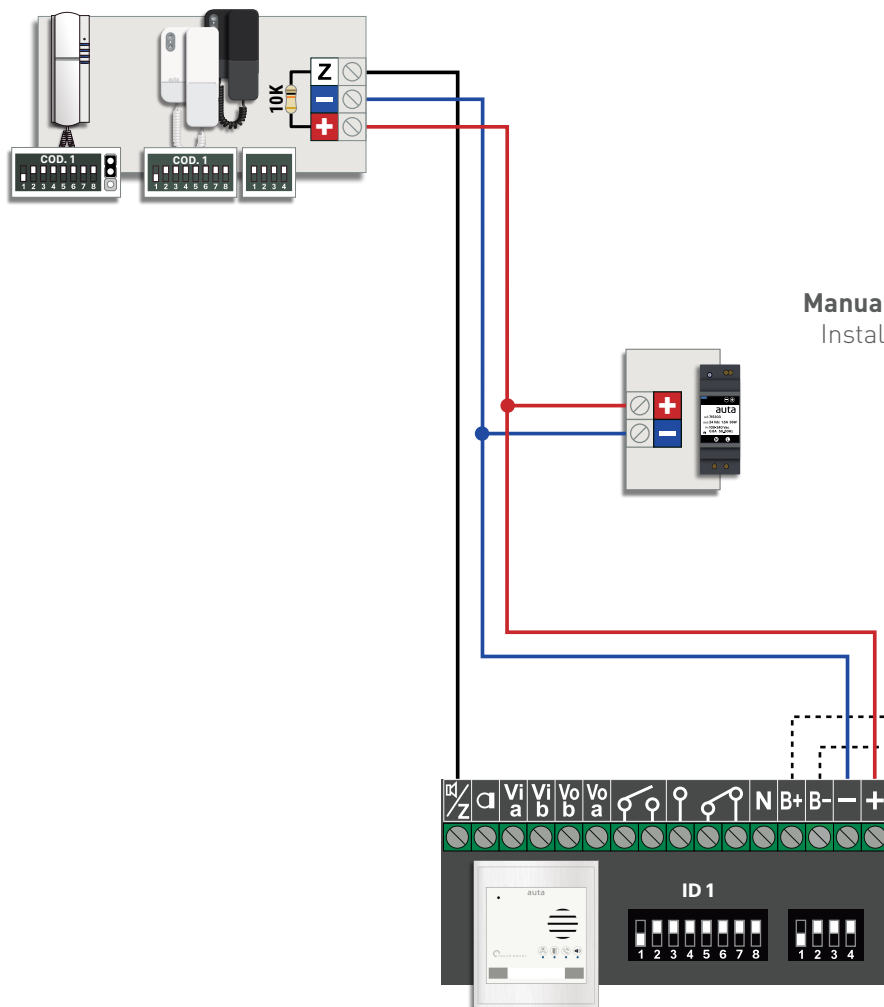

Manual de instalación VIDEO VISUALTECH 5H
Installation manual VIDEO VISUALTECH 5W

Pulsador Auxiliar de Apertura
OpeningAuxiliary Push-Button

Configuración Configuration

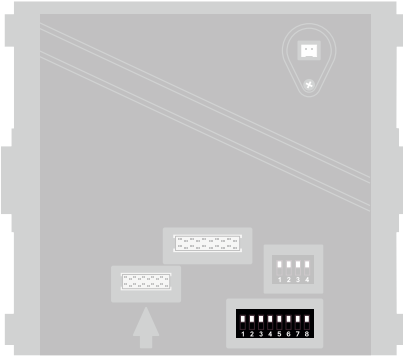

Configuración de ID de placa Panel ID configuration

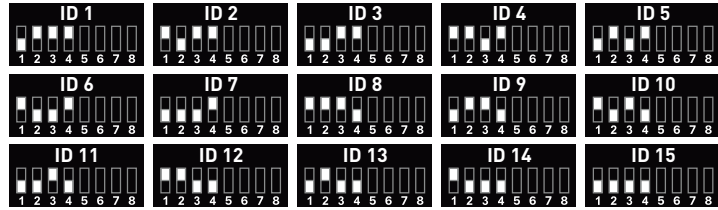

AUTO-ENCENDIDO a placa SELF-STARTING to panel



Llamada a CONSERJERÍA Call to CONCIERGE



Relé 2 Relay 2



Mensaje "PUERTA ABIERTA" "DOOR OPEN" message

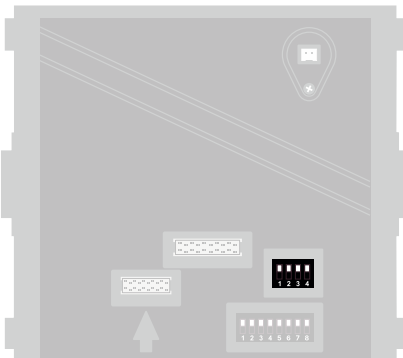

Selección PRINCIPAL _ SECUNDARIO MASTER _ SLAVE selection



! Sistema VISUALTECH SIEMPRE OFF
VISUALTECH system ALWAYS OFF





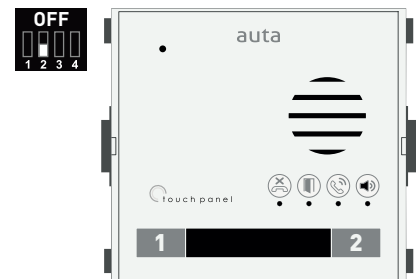
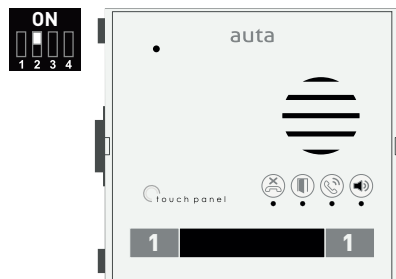



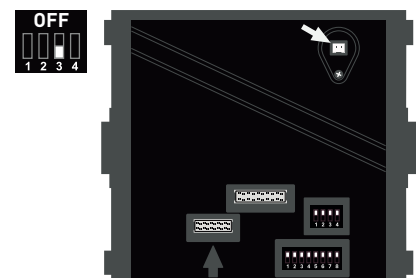
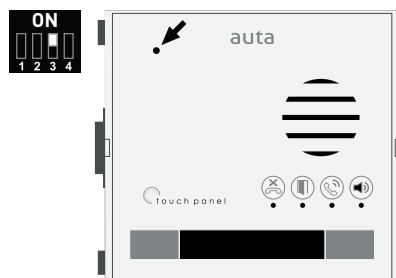































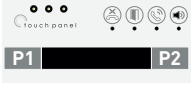





Selección de LLAMADA CALL selection



Selección de MICRÓFONO MICROPHONE selection



Funciones especiales Special functions

PASOS STEPS	FUNCIÓN FUNCTION	BINARIO BINARY
1º	Alimentar el módulo Supply the module	
2º	Anotar configuración del módulo Write down module settings	
3º	Entrar en modo programación Enter in programming mode  LEDS ON	 LEDS ON
4º	Configurar el código o códigos de función (tabla) Set the desired function code or codes (table)	
1	Re-assignar código de llamada pulsador IZQUIERDA (defecto código 1) Re-assign calling code to LEFT PUSH-BUTTON (default code 1)	 →  →  →  →  →  Nuevo cod. Llam. (1-254) New Call code (1-254)
2	Re-assignar código de llamada pulsador DERECHA Re-assign calling code to RIGHT PUSH-BUTTON	 →  →  →  →  →  Nuevo cod. Llam. (1-254) New Call code (1-254)
3	Re-assignar tiempo de apertura 1, vivienda (defecto 2 segundos) Re-assign opening time 1, flat (default 2 seconds)	 →  →  →  →  →  Nuevo Tiempo (1-30) New Time (1-30)
4	Re-assignar tiempo de apertura 2, pulsador externo y código (defecto 5 segundos) Re-assign opening time 2, external button and code (default 5 seconds)	 →  →  →  →  →  Nuevo Tiempo (1-30) New Time (1-30)
6	Placa configurada como EXTERIOR (bus X SDL) (habilitar llamada a conserjería) Panel configured as EXTERNAL (X SDL bus) (activate concierge call)	 →  →   P1 CONSERJE (SDL: 0 M/T: 0) CONCIERGE (SDL: 0 M/T: 0) P2 SDL: 1 M/T: 2
7	Código de SDL al que llamará P1 (el cod. de vivienda será el asignado en la func. 1) SDL code where P1 will call (House code will be the one assigned in function 1)	 →  →  →  →  →  Nº SDL (1-254) SDL nº (1-254)
8	Código de SDL al que llamará P2 (el cod. de vivienda será el asignado en la func. 2) SDL code where P2 will call (House code will be the one assigned in function 2)	 →  →  →  →  →  Nº SDL (1-254) SDL nº (1-254)
9	Placa configurada como INTERIOR (anula función 6) Panel configured as INTERNAL (disable func. 6)	 →  → 

Funciones especiales Special functions

129	Mensaje "Puerta abierta" en ESPAÑOL "Door open" message in SPANISH	
130	Mensaje "Puerta abierta" en CATALÁN "Door open" message in CATALAN	
131	Mensaje "Puerta abierta" en INGLÉS "Door open" message in ENGLISH	
132	Mensaje "Puerta abierta" en PORTUGUÉS "Door open" message in PORTUGUESE	
133	Mensaje "Puerta abierta" en FRANCÉS "Door open" message in FRENCH	
255	Valores de fábrica Factory settings	

5°

Salir del modo programación



Exit of programming mode



6°

Restablecer configuración del módulo (paso 2º)

Restore the module configuration (step 2º)

Ajuste de volumen Volume adjust

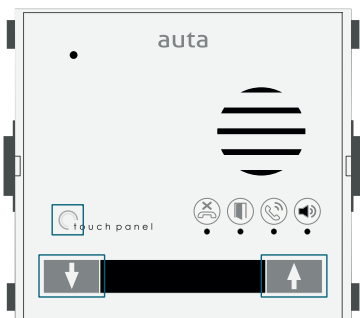

Entrar en modo ajuste de volumen Enter in volume adjust mode

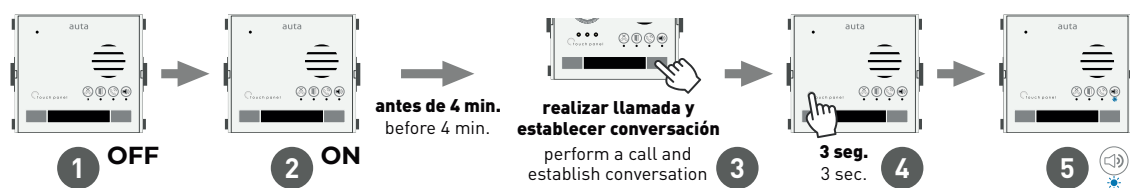

Existen 3 parámetros en los que podemos realizar ajustes de volumen:

1. Volumen de AUDIO en PLACA
2. Volumen de AUDIO en VIVIENDA
3. Volumen de AUDIO en mensaje "PUERTA ABIERTA"

Disponemos de 8 niveles de audio seleccionables, representados por 4 LEDS azules. Cada led indica 2 niveles.

There are 3 parameters in which we can make volume adjustments:

1. AUDIO volume at PANEL
2. AUDIO volume at HOUSING
3. AUDIO volume for "DOOR OPEN" message

We have 8 selectable audio levels, represented by 4 blue LEDs. Each led indicates 2 levels.

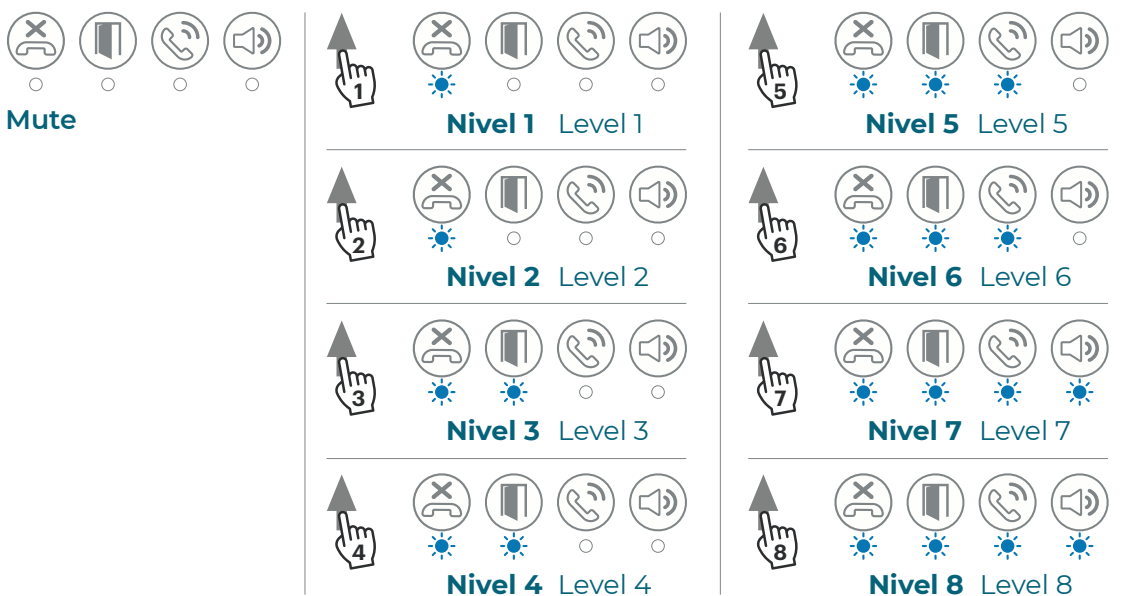

Modo mantenimiento Maintenance mode

El modo mantenimiento es un modo en el que la placa desactiva todos sus módulos conectados por seguridad, así se pueden realizar procedimientos tales como limpieza o la colocación de información en los tarjeteros de los pulsadores, con total seguridad.

El tiempo máximo en el que la placa permanece en modo mantenimiento es de 4 minutos. Pasado este tiempo se deberá re-armar.

The maintenance mode is a mode in which the panel deactivates all its connected modules for safety reasons, so procedures such as cleaning or placing information in the button card holders, can be carried out in complete safety.

The maximum time that the panel remains in maintenance mode is 4 minutes. After this time, it must be re-armed.

Entrar en modo mantenimiento Enter in maintenance mode

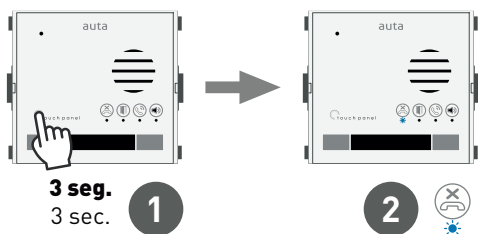

Ajuste de balance Balance adjust

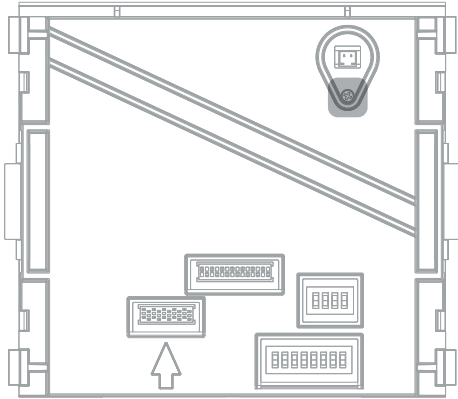

Ajuste de balance de audio.

Girar ligeramente hacia la derecha o izquierda hasta que el sonido de acoplamiento desaparezca.

Cada vez que se ajusta el volumen de audio hacia vivienda o hacia placa, se deberá re-ajustar de nuevo el balance general.

Audio balance adjustment.

Rotate slightly to the right or left until the coupling sound disappears.

Each time the audio volume towards the home or the panel is adjusted, the general balance must be re-adjusted again.

Montaje Mounting

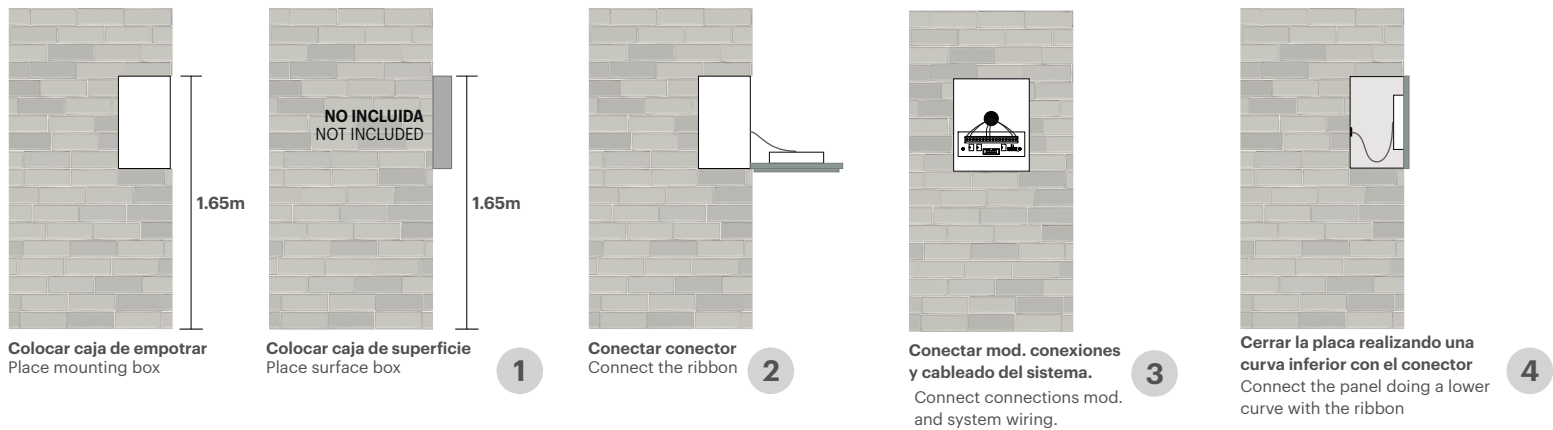



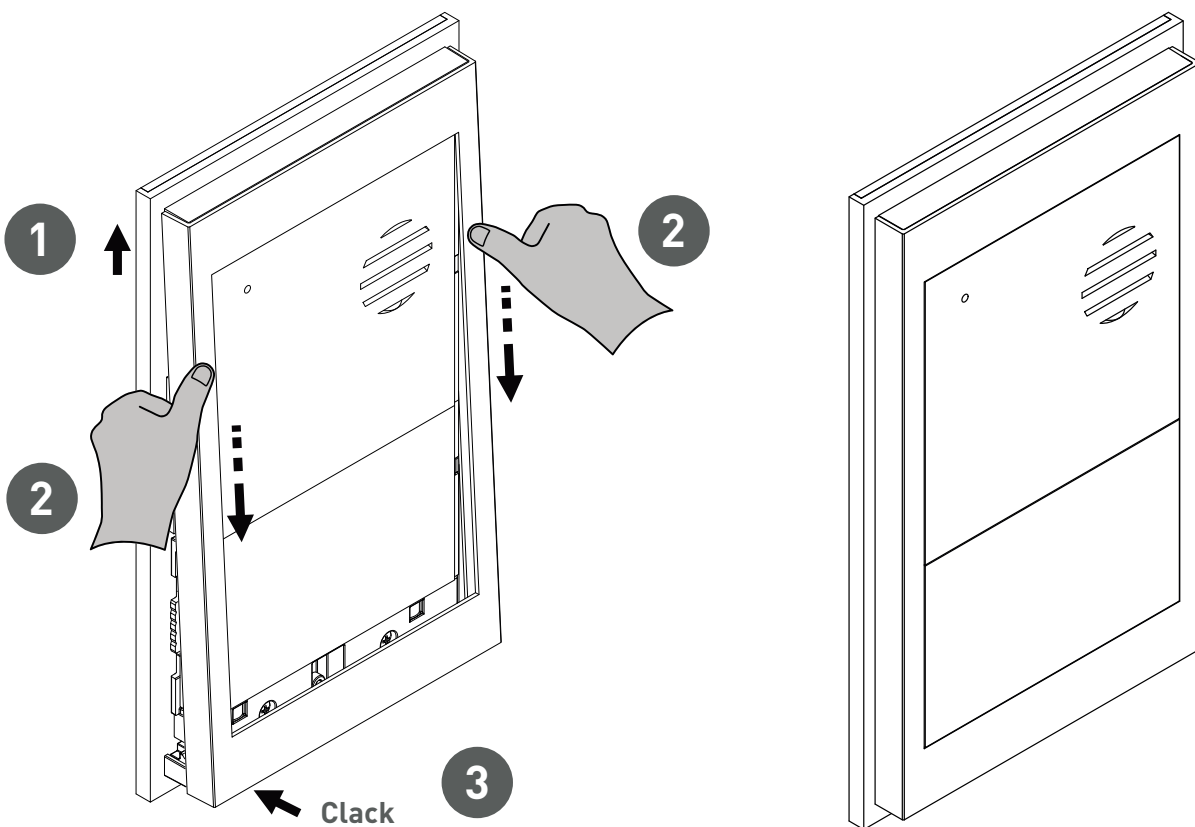

Montaje del perfil Profile assembly



Nº MÁXIMO DE ELEMENTOS MAX. NUMBER OF ELEMENTS

ELEMENTOS UNITS	ALV-1.5A (715303)	ALV-2.5A (715703)
 LLAMADA SIMULTANEA SIMULTANEOUS CALL	3	5

SECCIONES Y CONEXIONES RECOMENDADAS RECOMMENDED SECTIONS AND CONNECTIONS

	CAT 5/6/FTP	AUTA
par NARANJA ORANGE pair		+
par VERDE GREEN pair		-
par AZUL BLUE pair		-
par MARRÓN BROWN pair		Z
	100% COBRE	100% COPPER

SECCIONES WIRING SECTIONS	HASTA 100m UP TO 100m
+ - Z	0.22mm AWG22
EL CABLEADO NO DEBE PASAR CERCA DE LA LINEA ELÉCTRICA WIRING MUST NOT BE RUN CLOSE TO THE ELECTRICAL LINE	

GESTIÓN DE ABREPUERTAS DOOR OPENER MANAGEMENT

