

auta

ANALOG



REF. 744302



REF. 744342



REF. 749702

ES KF-2 S1

EN KF-2 S1

PT KF-2 S1

FR KF-2 S1

auta

Bringing people together

Elementos en el kit Elements in the kit

ítems no kit Éléments dans le kit



x1

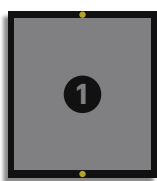

x1



x2

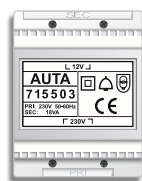

x1



x1

Características Features

Caraterísticas Caractéristiques

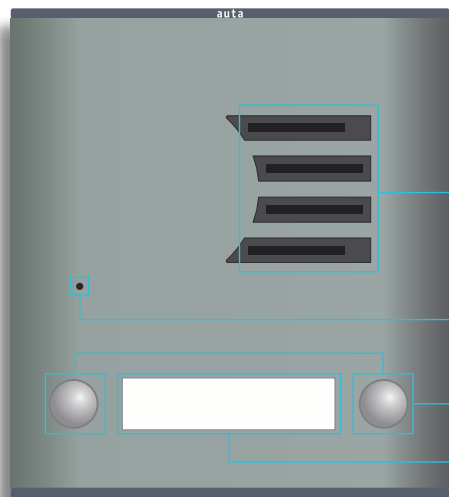

● **Altavoz Alto-falante**
Speaker Haut-parleur

● **Micrófono Microfone**
Microphone Microphone

● **Pulsadores de llamada Botões de chamada**
Call push-buttons Boutons d'appel

● **Tarjetero de información Cartão de informação**
Information cardholder Carte d'information

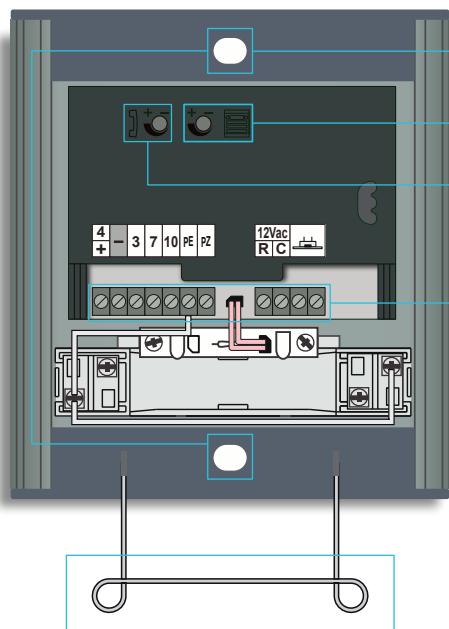

● **Orificios de fijación Orifícios de fixação**
Placement holes Trous de fixation

● **Volumen de audio en placa Volume de áudio a placa**
Panel audio volume Volume audio à panneau

● **Volumen de audio en vivienda Volume de áudio na moradia**
Flat audio volume Volume audio dans le boîtier

● **Conexiones Connections Conexões** Les connexions

+	+9 Vcc (salida)	+9 Vdc (out)	+9 Vcc (sair)	+9 Vcc (sortir)
-	-9 Vcc (salida)	-9 Vdc (out)	-9 Vcc (sair)	-9 Vcc (sortir)
3	Micrófono	Microphone	Microfone	Microphone
7	Altavoz	Speaker	Alto-falante	Haut-parleur
10	Apertura	Opening	Abertura	Ouverture
PE	Sistema de llamada ELECTRÓNICA	ELECTRONIC call system	Sistema de chamada ELETRÔNICA	Système d'appel ÉLECTRONIQUE
PZ	Llamada ZUMBADOR	BUZZER call	Chamada BUZZER	Appel BUZZER
R	12 Vca (ALIMENTADOR)	12 Vac (SUPPLY)	12 Vca (ALIMENTADOR)	12 Vca (CHARGEUR)
C	12 Vca (ALIMENTADOR)	12 Vac (SUPPLY)	12 Vca (ALIMENTADOR)	12 Vca (CHARGEUR)
	Terminal 1, cerradura (12 Vca)	Terminal, 1 lock (12 Vac)	Terminal 1, trava (12 Vca)	Terminal 1, serrure (12 Vca)
	Terminal 2, cerradura (12 Vca)	Terminal 2, lock (12 Vac)	Terminal 2, trava (12 Vca)	Terminal 2, serrure (12 Vca)
	Alimentación LEDS (12 Vca)	LEDS supply (12 Vac)	Poder LEDS (12 Vca)	Puissance LEDS (12 Vca)

● **Soporte de apoyo para caja de empotrar**
Hook support for mounting box

● **Supporte de supporte para caixa embutida**
Support de support pour boîtier encastré

Montaje Mounting

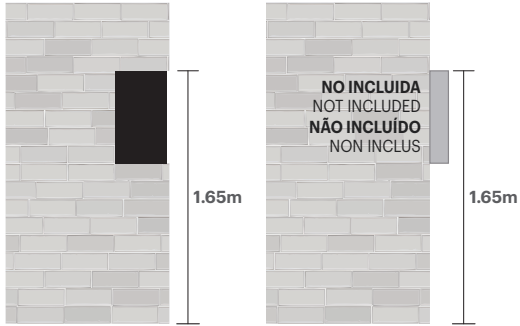

Colocar caja de empotrar
Place mounting box
Coloque a caixa embutida
Placez la boîte encastrée

Colocar caja de superficie
Place surface box
Coloque a caixa de superficie
Place surface box

1

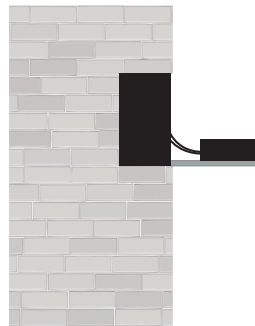

Conectar el cableado
Connect the wiring
Conecte o cabos
Connecter le câblage

2



Cerrar la placa realizando una curva inferior con el cableado
Connect the panel doing a lower curve with the wiring
Feche a placa fazendo uma curva mais baixa com a fiação
Fermer la plaque en faisant une courbe inférieure avec le câblage

3

Colocar información en el tarjetero

Place information in the cardholder

Coloque as informações no titular do cartão

Placez les informations dans le titulaire de la carte

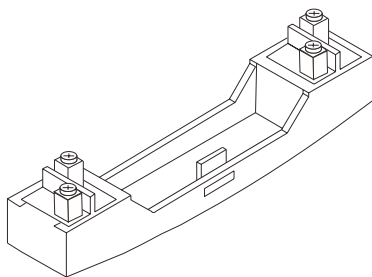

1

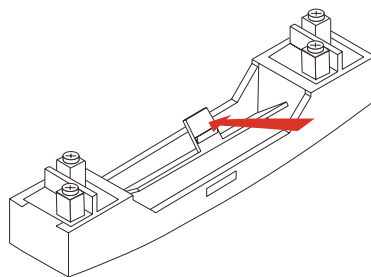

2

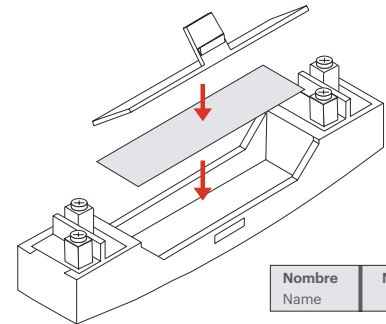



3

Nombre	Nombre
Name	Name

Instalación Installation

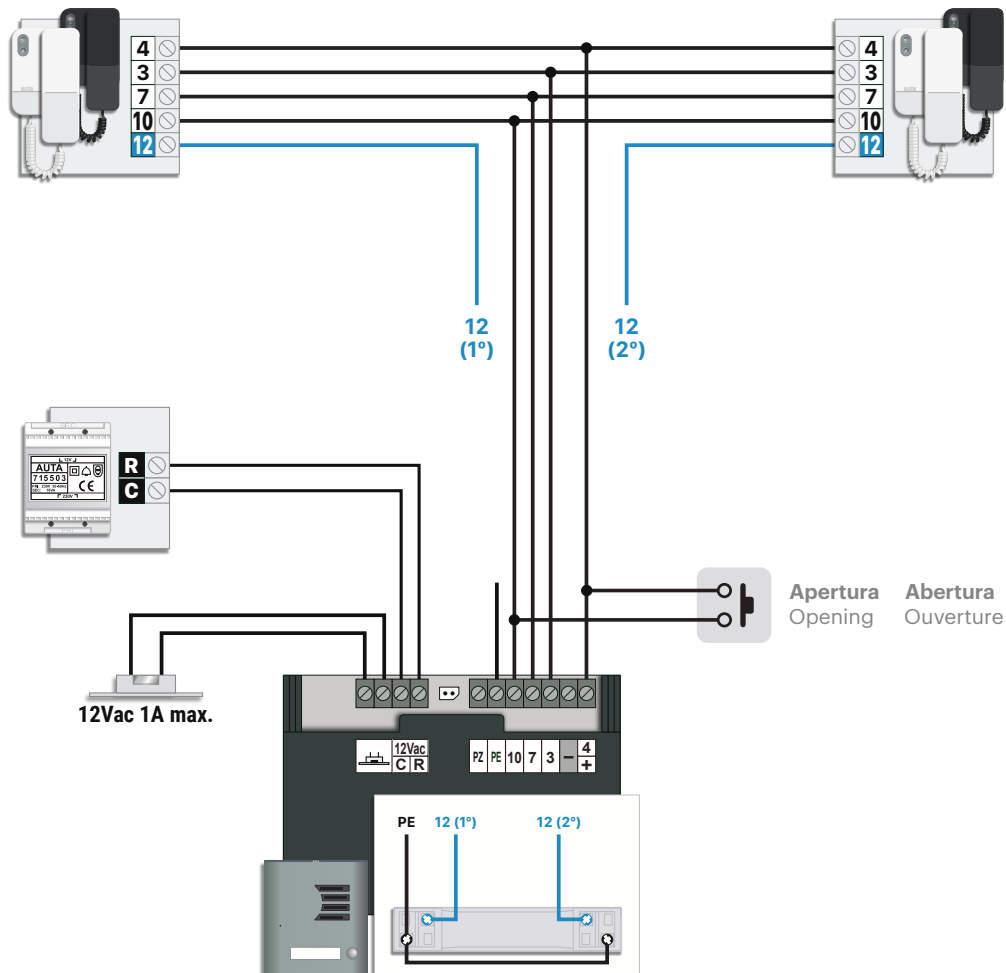
Instalação L'installation



ELEMENTOS UNITS	ATF-12 (715503)
 LLAMADA SIMULTANEA SIMULTANEOUS CALL	2

SECCIONES WIRING SECTIONS	HASTA 100m UP TO 100m	HASTA 200m UP TO 200m
+4 3 7 10 12	0.5mm AWG20	1mm AWG17
12 Vac 	1mm AWG17	

EL CABLEADO NO DEBE PASAR CERCA DE LA LINEA ELÉCTRICA
WIRING MUST NOT BE RUN CLOSE TO THE ELECTRICAL LINE