

auta

DIGITAL



REF. 744202



REF. 744242



REF. 749812

ES KF-2 S1

EN KF-2 S1

PT KF-2 S1

FR KF-2 S1

auta

Bringing people together

Elementos en el kit Elements in the kit

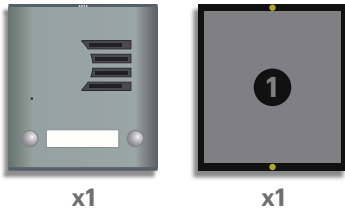

itens no kit Éléments dans le kit

Características Features

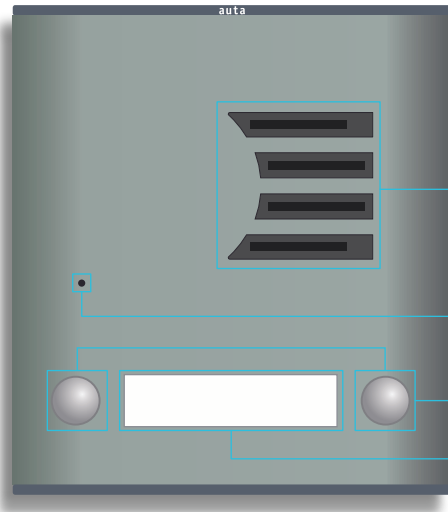

- **Altavoz Speaker**
- **Micrófono Microphone**
- **Pulsadores de llamada Call push-buttons**
- **Tarjetero de información Information cardholder**

Características Caractéristiques

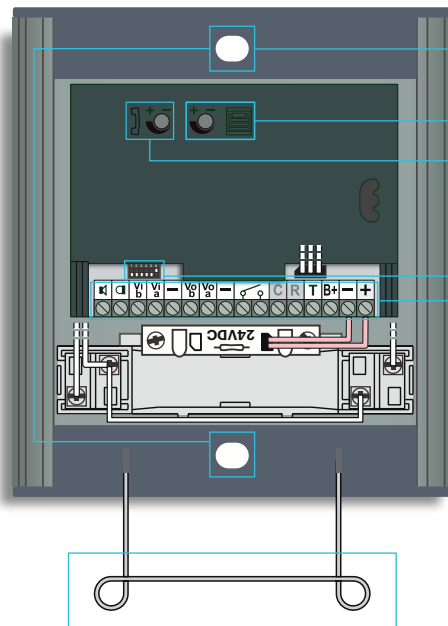

- **Orificios de fijación Placement holes**
- **Volumen de audio en placa Panel audio volume**
- **Volumen de audio en vivienda Flat audio volume**

- **ID de placa (binario) Panel ID (binary)**

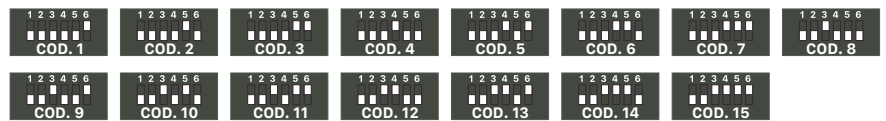

- **Conexiones Connections**

	Altavoz_Datos	Speaker_Data
	Micrófono	Microphone
Vi_b	NO USADO	NOT USED
Vi_a	NO USADO	NOT USED
Vo_b	NO USADO	NOT USED
Vo_a	NO USADO	NOT USED
	Relé libre de tensión N.A. _1A	Free tension N.O. _1A relay
T	Salida +12 Vcc (solo durante la llamada_conversación)	Out +12 Vdc (only during the call_conversation)
B+	Pulsador apertura (entrada -)	Opening button (input -)
-	-24 Vcc (todos iguales)	-24 Vdc (all same)
+	+24 Vcc	+24 Vdc

- **Soporte de apoyo para caja de empotrar Hook support for mounting box**

Montaje Mounting

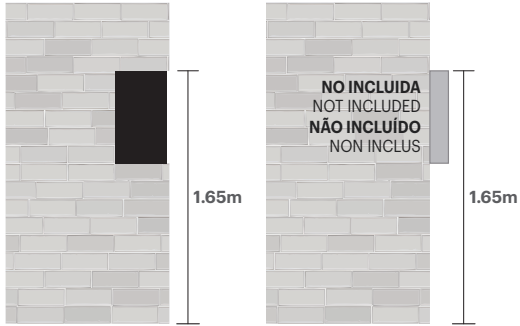

Colocar caja de empotrar
Place mounting box
Coloque a caixa embutida
Placez la boîte encastrée

Colocar caja de superficie
Place surface box
Coloque a caixa de superficie
Place surface box

1

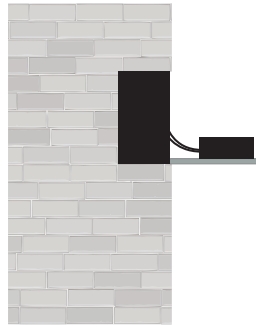

Conectar el cableado
Connect the wiring
Conecte o cabos
Connecter le câblage

2



3

Cerrar la placa realizando una curva inferior con el cableado
Connect the panel doing a lower curve with the wiring
Feche a placa fazendo uma curva mais baixa com a fiação
Fermer la plaque en faisant une courbe inférieure avec le câblage

Colocar información en el tarjetero Place information in the cardholder

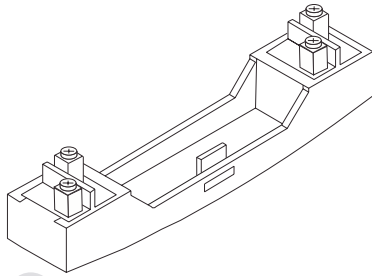

1

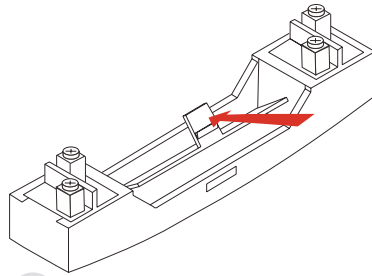

2

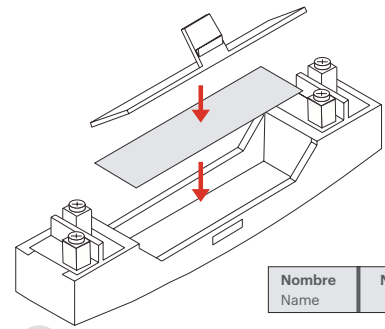

3

Instalación Installation

Instalação L'installation

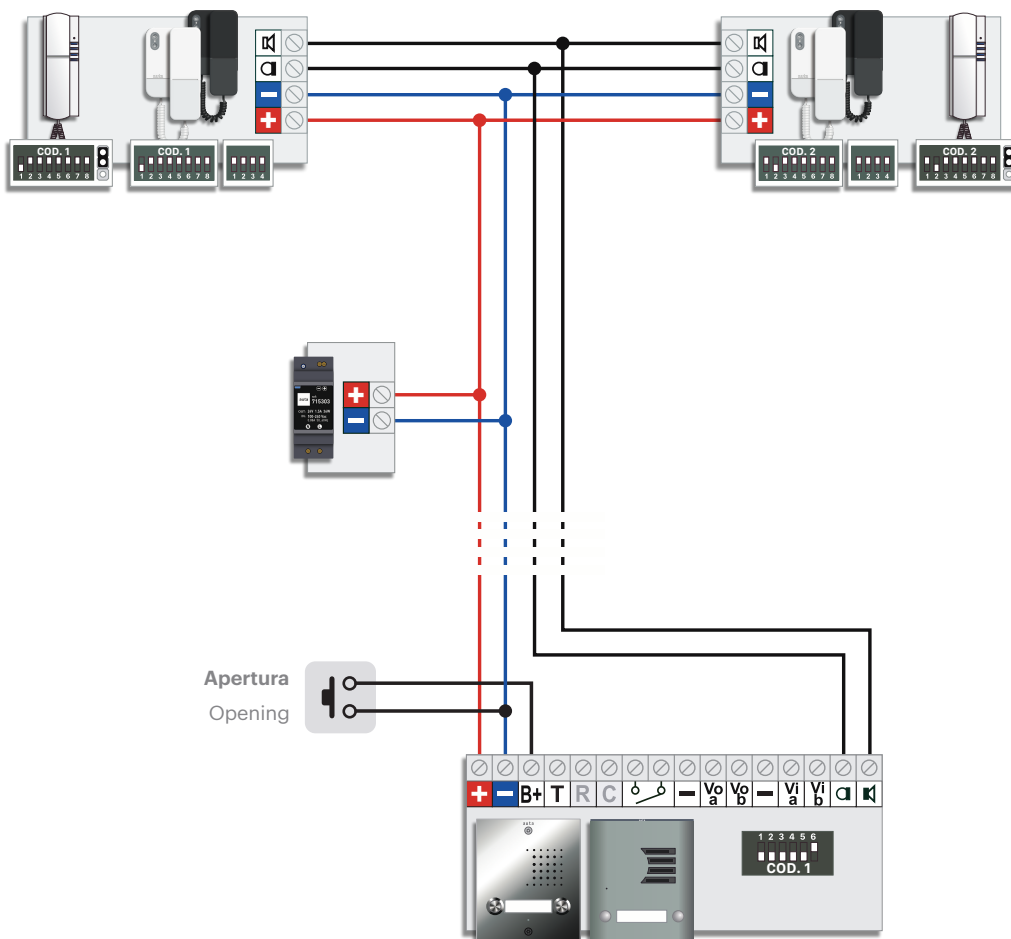







Manual de instalación AUDIO 4H
Installation manual AUDIO 4W

Nº MÁXIMO DE ELEMENTOS MAX. NUMBER OF ELEMENTS

ELEMENTOS UNITS	ALV-1.5A (715303)	ALV-2.5A (715703)
 LLAMADA SIMULTANEA SIMULTANEOUS CALL	3	5

SECCIONES Y CONEXIONES RECOMENDADAS RECOMMENDED SECTIONS AND CONNECTIONS

SECCIONES WIRING SECTIONS	HASTA 100m UP TO 100m	HASTA 200m UP TO 200m
+ -	1mm AWG17	1.5mm AWG15
 	0.5mm AWG20	1mm AWG17
EL CABLEADO NO DEBE PASAR CERCA DE LA LINEA ELÉCTRICA WIRING MUST NOT BE RUN CLOSE TO THE ELECTRICAL LINE		

CAT 5/6/FTP	AUTA
	+
	-
	
	
100% COBRE 100% COPPER	

GESTIÓN DE ABREPUERTAS DOOR OPENER MANAGEMENT

