

avant

DIGITAL

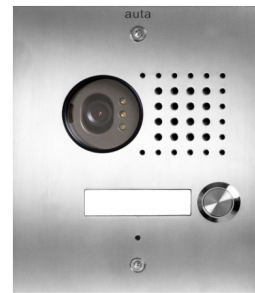
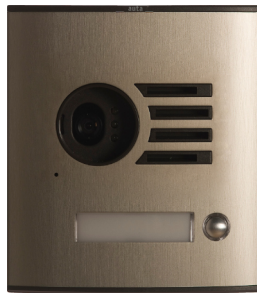

ES KVD-1 S1 NO-COAX

EN KVD-1 S1 COAXLESS

auta

Bringing people together

Elementos en el kit Elements in the kit



Características Features

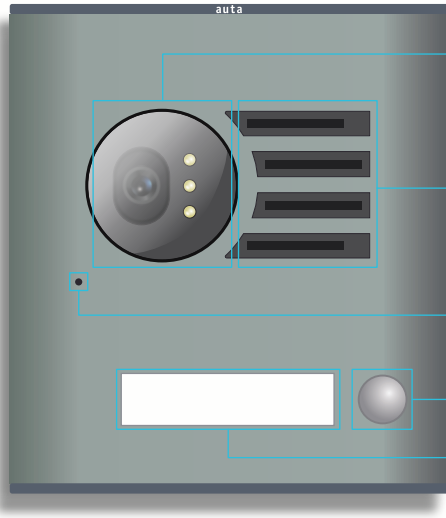

- **Módulo de video** Video module
- **Altavoz** Speaker
- **Micrófono** Microphone
- **Pulsador de llamada** Call push-button
- **Tarjetero de información** Information cardholder

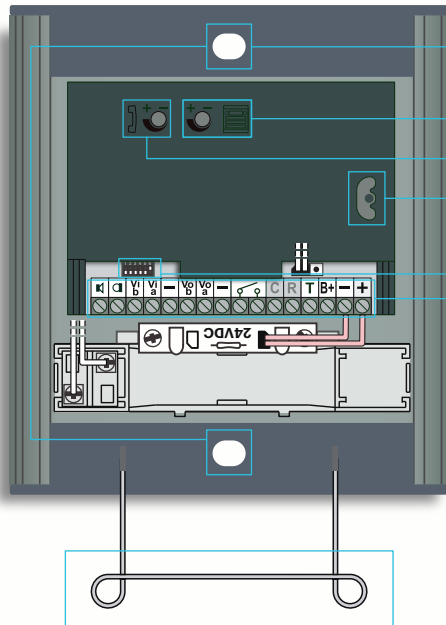

- **Orificios de fijación** Placement holes
- **Volumen de audio en placa** Panel audio volume
- **Volumen de audio en vivienda** Flat audio volume
- **Inclinación vertical de cámara ± 15°** Camera vertical inclination ± 15°

- **ID de placa (binario)** Panel ID (binary)

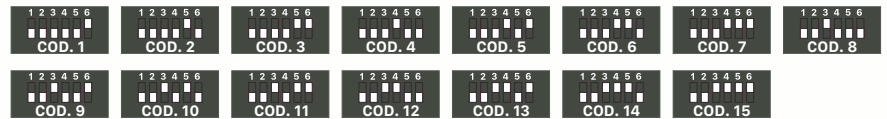

- **Conexiones** Connections

	Altavoz_Datos	Speaker_Data
	Micrófono	Microphone
Vi_b	NO USADO	NOT USED
Vi_a	Video (entrada)	Video (in)
Vo_b	NO USADO	NOT USED
Vo_a	Video (salida)	Video (out)
	Relé libre de tensión N.A. _1A	Free tension N.O. _1A relay
T	Salida +12 Vcc (solo durante la llamada_conversación)	Out +12 Vdc (only during the call_conversation)
B+	Pulsador apertura (entrada -)	Opening button (input -)
-	-24 Vcc (todos iguales)	-24 Vdc (all same)
+	+24 Vcc	+24 Vdc

- **Soporte de apoyo para caja de empotrar** Hook support for mounting box

Montaje Mounting

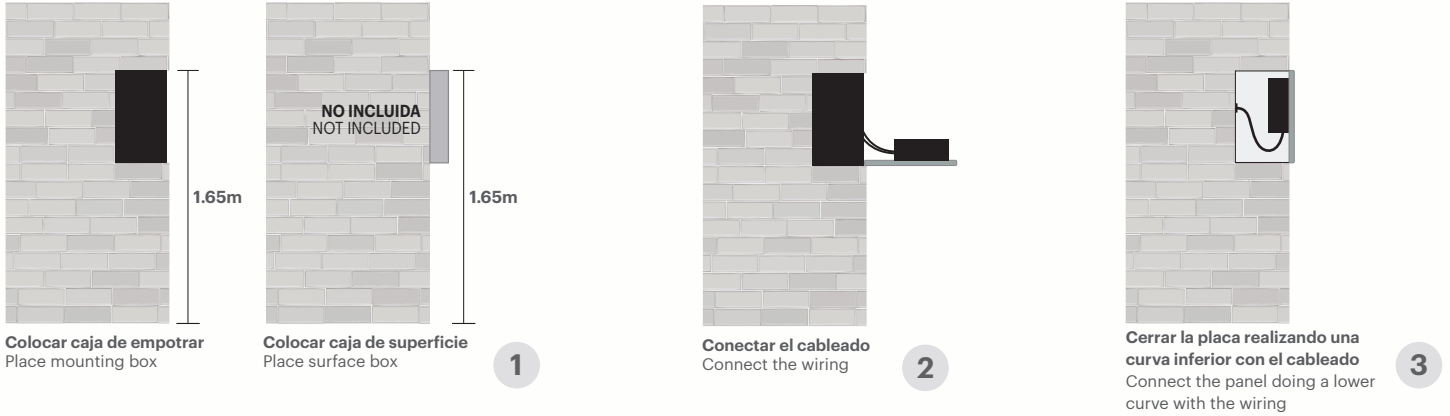

Colocar información en el tarjetero Place information in the cardholder

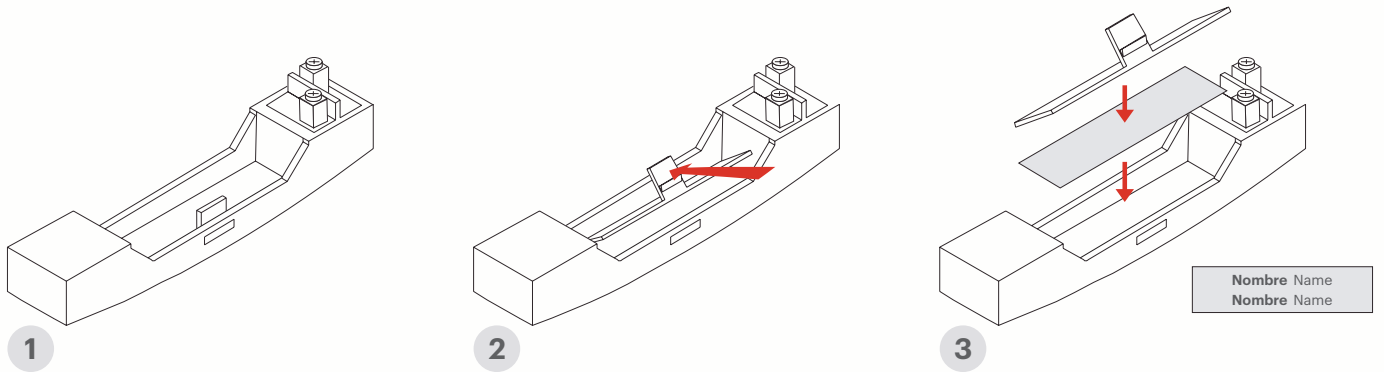

Instalación Installation

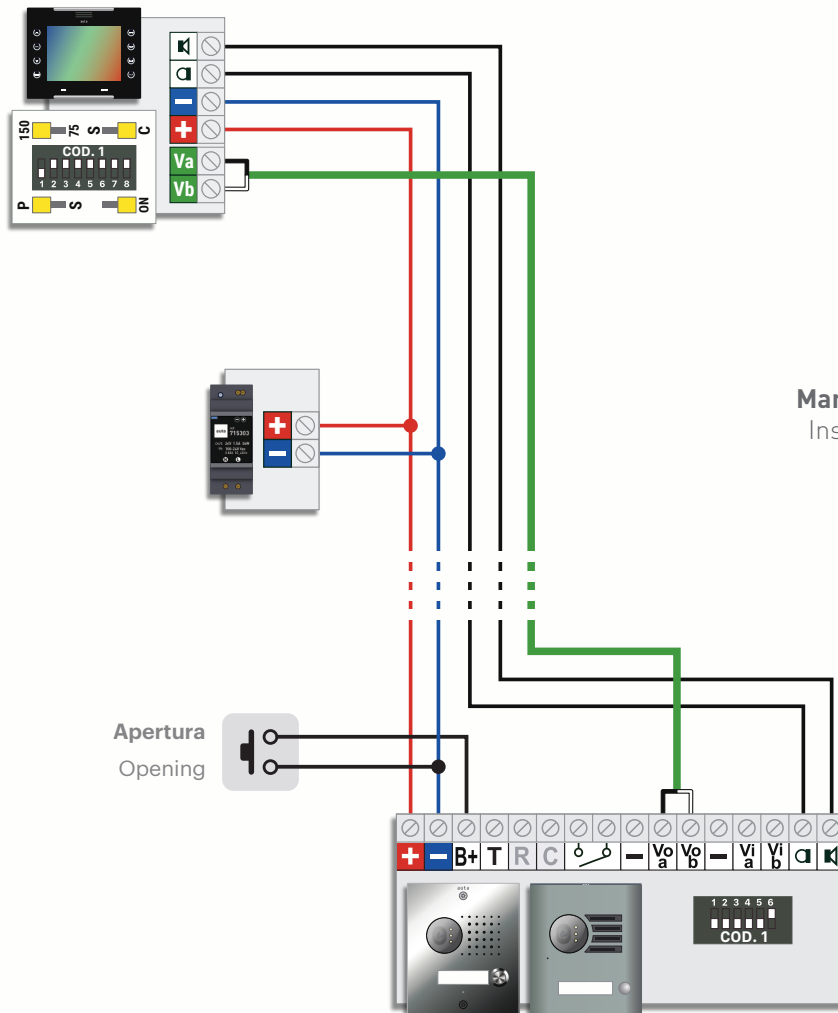









Manual de instalación VIDEO NO-COAX
Installation manual VIDEO COAXLESS

Nº MÁXIMO DE ELEMENTOS MAX. NUMBER OF ELEMENTS

ELEMENTOS UNITS	ALV-1.5A (715303)	ALV-2.5A (715703)
 LLAMADA SIMULTANEA SIMULTANEOUS CALL	3	5

SECCIONES Y CONEXIONES RECOMENDADAS RECOMMENDED SECTIONS AND CONNECTIONS

	CAT 5/6/FTP	AUTA
par NARANJA ORANGE pair		+
par VERDE GREEN pair		-
cable AZUL_BLANCO BLUE_WHITE wire		Va
cable AZUL BLUE wire		Vb
cable MARRÓN_BLANCO BROWN_WHITE wire		
cable MARRÓN BROWN wire		
	100% COBRE	100% COPPER

SECCIONES WIRING SECTIONS	HASTA 100m UP TO 100m	HASTA 200m UP TO 200m
+ -	1mm AWG17	1.5mm AWG15
 	0.5mm AWG20	1mm AWG17
Va Vb	2 x 0.22mm AWG22	
EL CABLEADO NO DEBE PASAR CERCA DE LA LINEA ELÉCTRICA WIRING MUST NOT BE RUN CLOSE TO THE ELECTRICAL LINE		

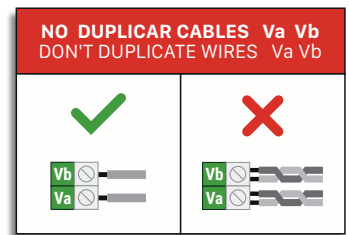

GESTIÓN DE ABREPUERTAS DOOR OPENER MANAGEMENT

