

# neos

## DIGITAL

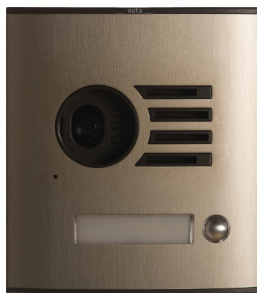

REF: 745191

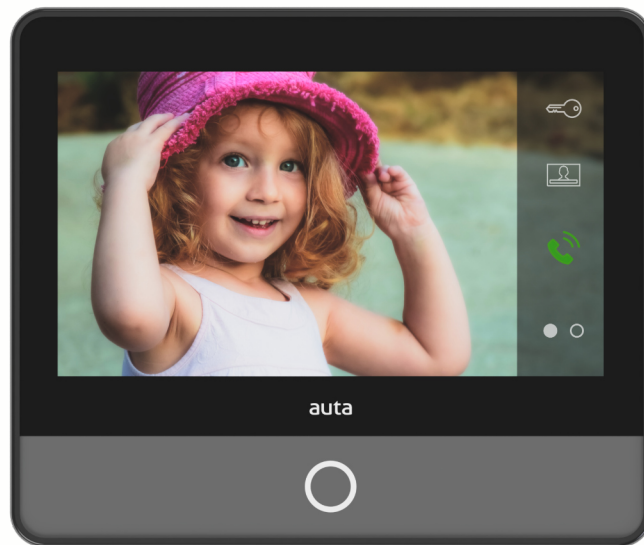
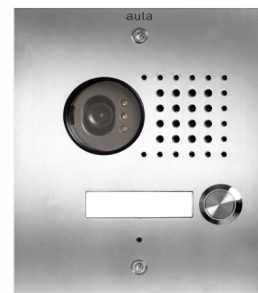

REF: 745193

ES KVD-1 S1 VISUALTECH 5H

EN KVD-1 S1 VISUALTECH 5W

auta

Bringing people together

## Elementos en el kit Elements in the kit



## Características Features

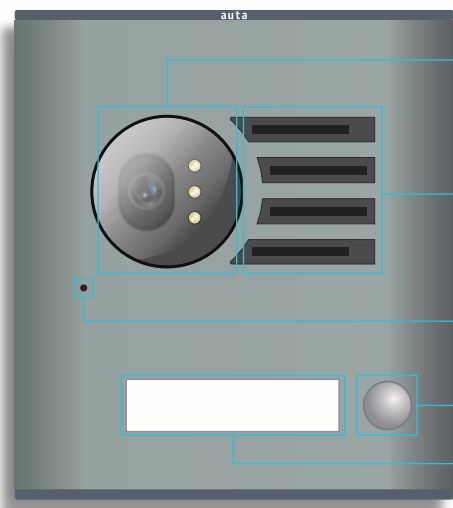

- **Módulo de video** Video module
- **Altavoz** Speaker
- **Micrófono** Microphone
- **Pulsador de llamada** Call push-button
- **Tarjetero de información** Information cardholder

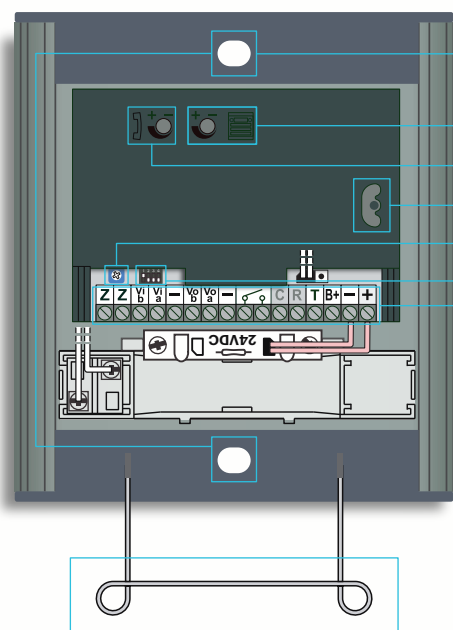

- **Orificios de fijación** Placement holes
- **Volumen de audio en placa** Panel audio volume
- **Volumen de audio en vivienda** Flat audio volume
- **Inclinación vertical de cámara ± 15°** Camera vertical inclination ± 15°
- **Ajuste de balance (elimina acoplamiento en audio)** Balance adjust (removes audio feedback)
- **ID de placa (binario)** Panel ID (binary)



### Conexiones Connections

Z	Audio_Datos	Audio_Data
Vi_b	Video - (entrada)	Video - (in)
Vi_a	Video + (entrada)	Video + (in)
Vo_b	Video - (salida)	Video - (out)
Vo_a	Video + (salida)	Video + (out)
☐	Relé libre de tensión N.A. _1A	Free tension N.O. _1A relay
T	Salida +12 Vcc (solo durante la llamada_conversación)	Out +12 Vdc (only during the call_conversation)
B+	Pulsador apertura (entrada -)	Opening button (input -)
-	-24 Vcc (todos iguales)	-24 Vdc (all same)
+	+24 Vcc	+24 Vdc

- **Soporte de apoyo para caja de empotrar** Hook support for mounting box

## Montaje Mounting



Colocar caja de empotrar  
Place mounting box

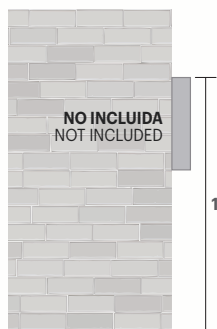

Colocar caja de superficie  
Place surface box

1

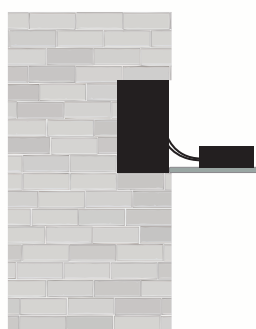

Conectar el cableado  
Connect the wiring

2

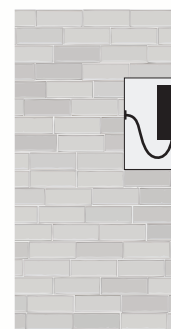

Cerrar la placa realizando una curva inferior con el cableado  
Connect the panel doing a lower curve with the wiring

3

## Colocar información en el tarjetero Place information in the cardholder

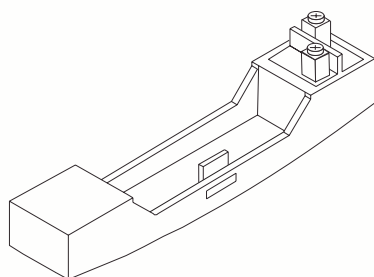

1

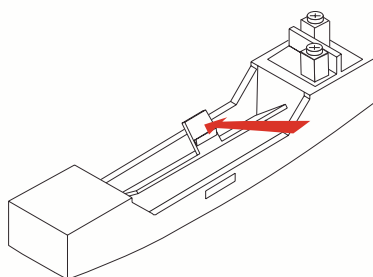

2

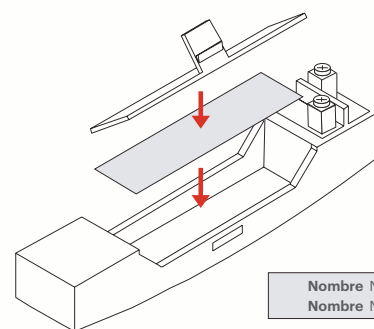

3

Nombre Name  
Nombre Name

## Instalación Installation

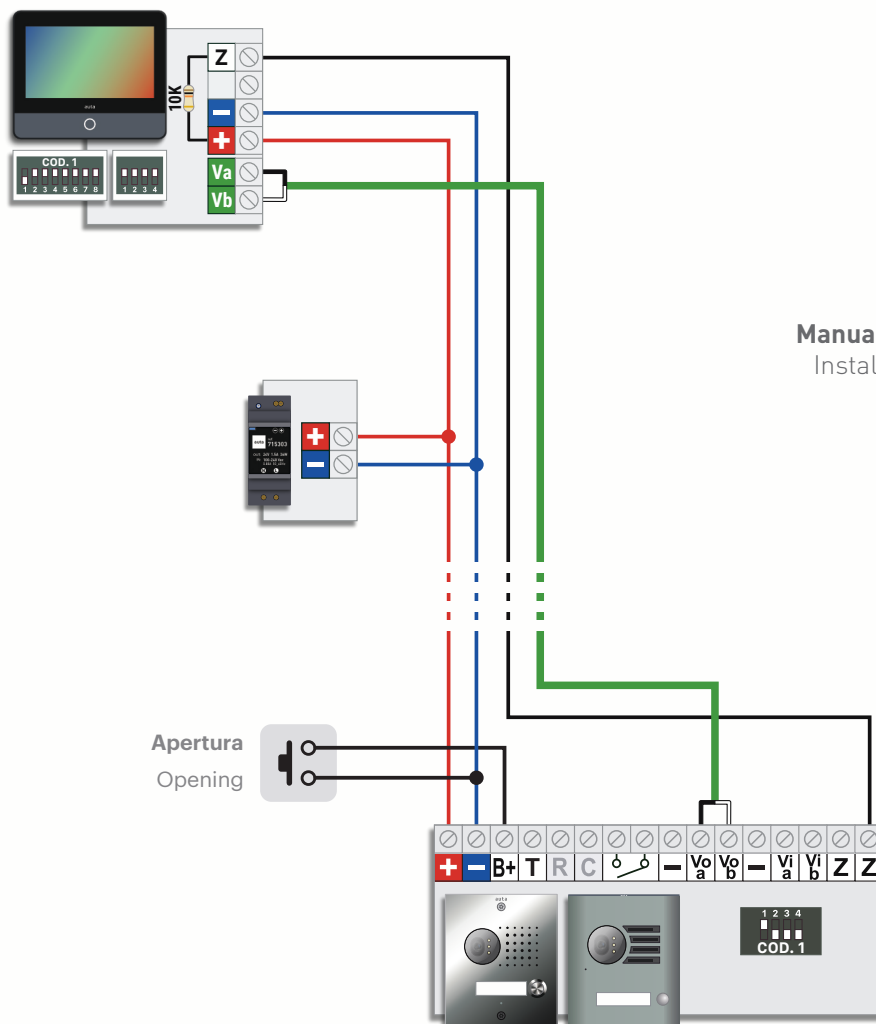





Manual de instalación VIDEO VISUALTECH 5H  
Installation manual VIDEO VISUALTECH 5W

## Nº MÁXIMO DE ELEMENTOS MAX. NUMBER OF ELEMENTS

ELEMENTOS UNITS	ALV-1.5A (715303)	ALV-2.5A (715703)
 LLAMADA SIMULTANEA SIMULTANEOUS CALL	<b>3</b>	<b>5</b>

## SECCIONES Y CONEXIONES RECOMENDADAS RECOMMENDED SECTIONS AND CONNECTIONS

	CAT 5/6/FTP	AUTA
par NARANJA ORANGE pair		<b>+</b>
par VERDE GREEN pair		<b>-</b>
cable AZUL_BLANCO BLUE_WHITE wire		<b>Va</b>
cable AZUL BLUE wire		<b>Vb</b>
par MARRÓN BROWN pair		<b>Z</b>
<b>100% COBRE 100% COPPER</b>		

SECCIONES WIRING SECTIONS	HASTA 100m UP TO 100m
<b>+ - Z Va Vb</b>	<b>0.22mm AWG22</b>
<b>EL CABLEADO NO DEBE PASAR CERCA DE LA LINEA ELÉCTRICA</b> WIRING MUST NOT BE RUN CLOSE TO THE ELECTRICAL LINE	

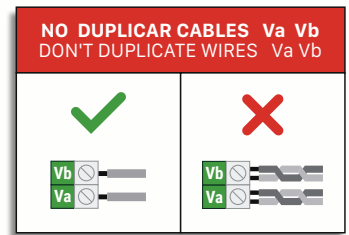

## GESTIÓN DE ABREPUERTAS DOOR OPENER MANAGEMENT

