

# slim

## DIGITAL

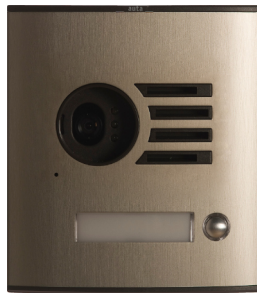

REF: 746111

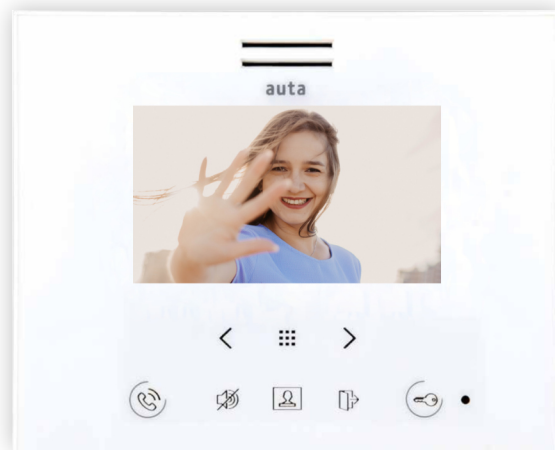
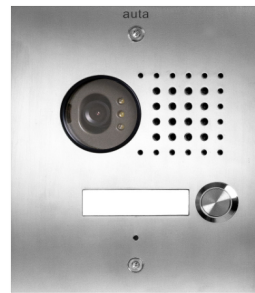

REF: 746131

ES KVD-1 S1 VISUALTECH 5H

EN KVD-1 S1 VISUALTECH 5W

auta

Bringing people together

## Elementos en el kit Elements in the kit



x1

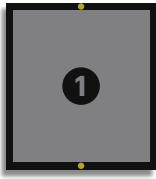

x1

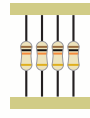

4 x 10K



x1

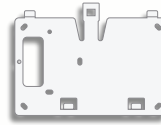

x1



x1



x1

## Características Features

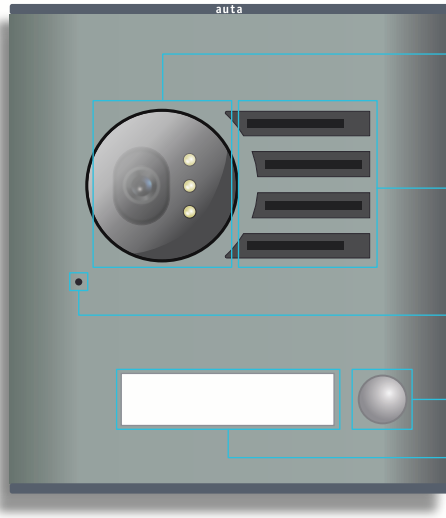

- **Módulo de video** Video module
- **Altavoz** Speaker
- **Micrófono** Microphone
- **Pulsador de llamada** Call push-button
- **Tarjetero de información** Information cardholder

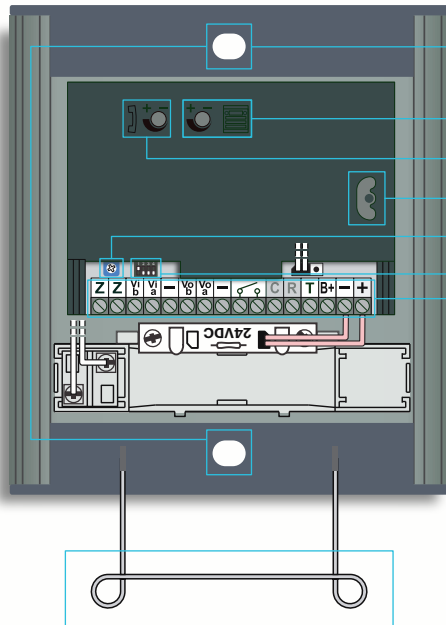

- **Orificios de fijación** Placement holes
- **Volumen de audio en placa** Panel audio volume
- **Volumen de audio en vivienda** Flat audio volume
- **Inclinación vertical de cámara ± 15°** Camera vertical inclination ± 15°
- **Ajuste de balance (elimina acoplamiento en audio)** Balance adjust (removes audio feedback)
- **ID de placa (binario)** Panel ID (binary)

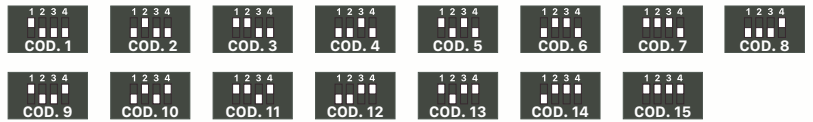

- **Conexiones** Connections

<b>Z</b>	Audio_Datos	Audio_Data
<b>Vi_b</b>	Video - (entrada)	Video - (in)
<b>Vi_a</b>	Video + (entrada)	Video + (in)
<b>Vo_b</b>	Video - (salida)	Video - (out)
<b>Vo_a</b>	Video + (salida)	Video + (out)
	Relé libre de tensión N.A. _1A	Free tension N.O. _1A relay
<b>T</b>	Salida +12 Vcc (solo durante la llamada_conversación)	Out +12 Vdc (only during the call_conversation)
<b>B+</b>	Pulsador apertura (entrada -)	Opening button (input -)
<b>-</b>	-24 Vcc (todos iguales)	-24 Vdc (all same)
<b>+</b>	+24 Vcc	+24 Vdc

- **Soporte de apoyo para caja de empotrar** Hook support for mounting box

## Montaje Mounting

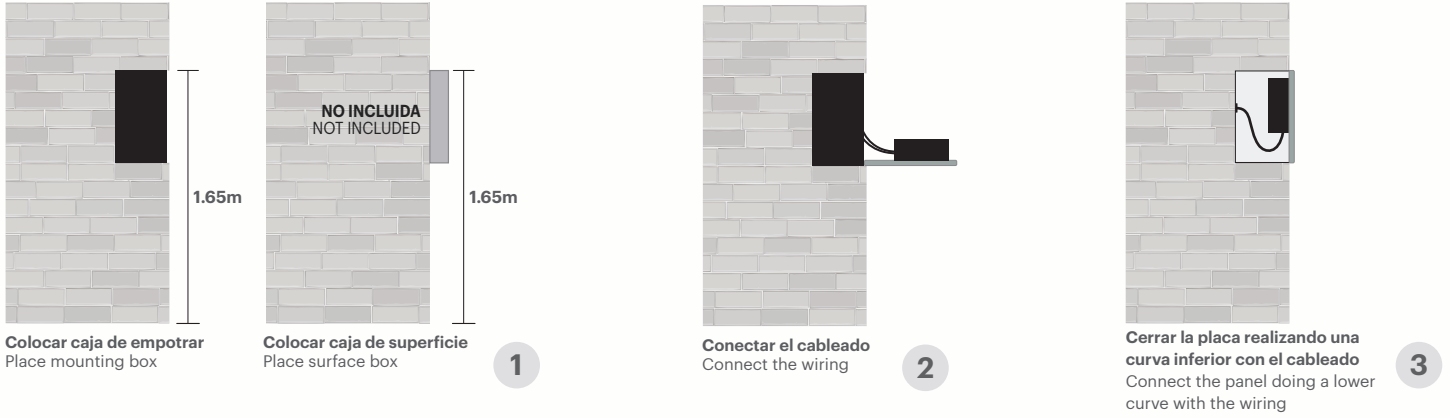

## Colocar información en el tarjetero Place information in the cardholder

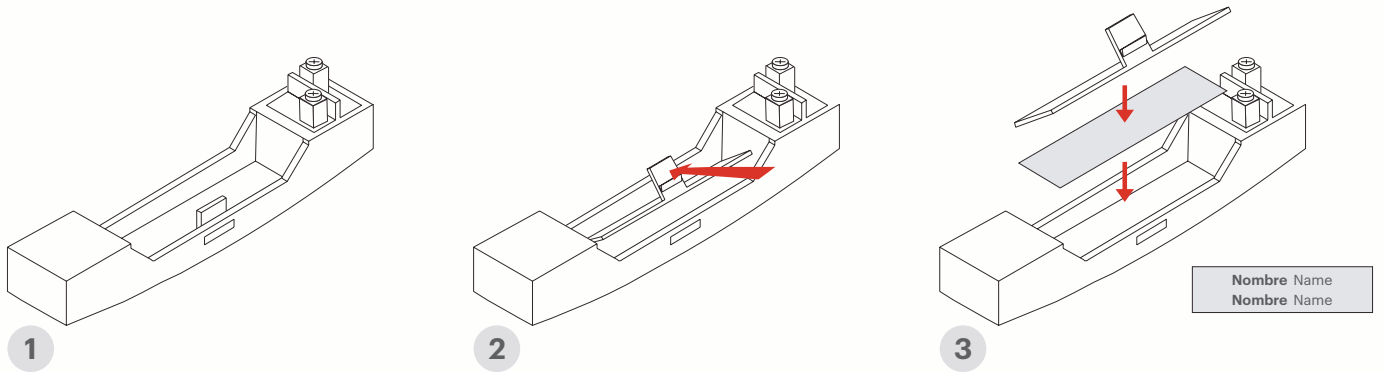

## Instalación Installation

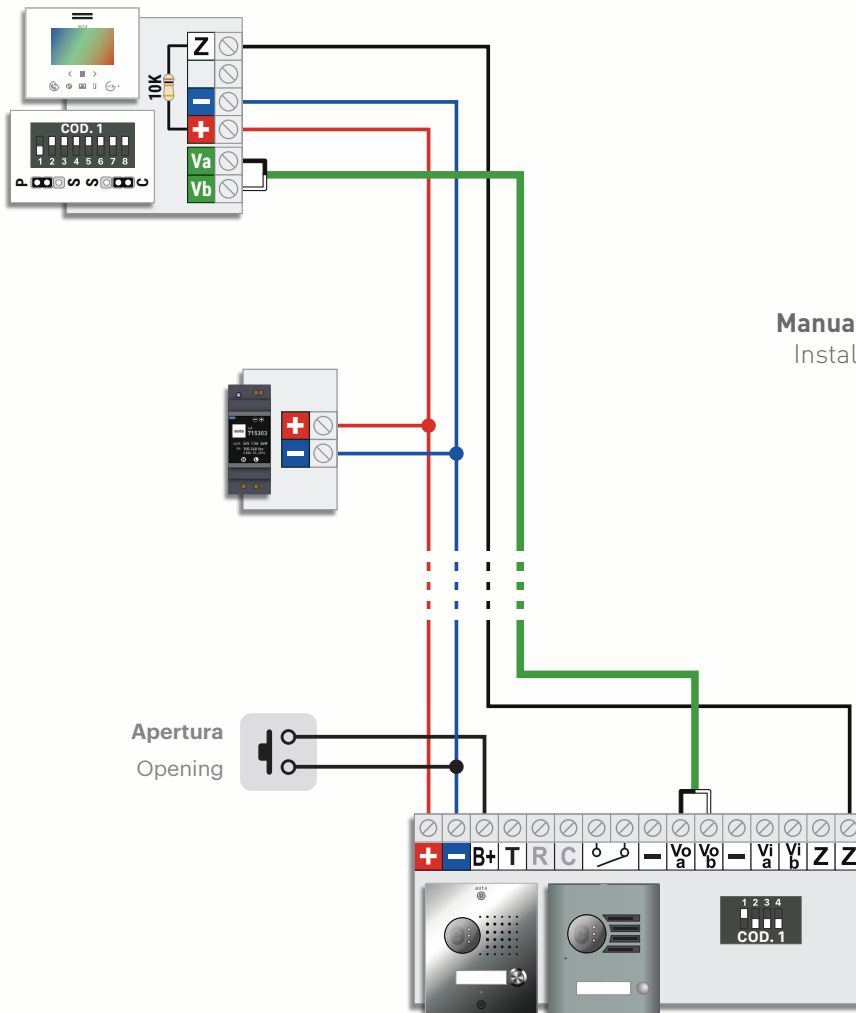





Manual de instalación VIDEO VISUALTECH 5H  
Installation manual VIDEO VISUALTECH 5H

**Nº MÁXIMO DE ELEMENTOS** MAX. NUMBER OF ELEMENTS

ELEMENTOS UNITS	ALV-1.5A (715303)	ALV-2.5A (715703)
 LLAMADA SIMULTANEA SIMULTANEOUS CALL	<b>3</b>	<b>5</b>

**SECCIONES Y CONEXIONES RECOMENDADAS** RECOMMENDED SECTIONS AND CONNECTIONS

	CAT 5/6/FTP	AUTA
par NARANJA ORANGE pair		<b>+</b>
par VERDE GREEN pair		<b>-</b>
cable AZUL_BLANCO BLUE_WHITE wire		<b>Va</b>
cable AZUL BLUE wire		<b>Vb</b>
par MARRÓN BROWN pair		<b>Z</b>
	<b>100% COBRE</b> 100% COPPER	

SECCIONES WIRING SECTIONS	HASTA 100m UP TO 100m
<b>+ - Z Va Vb</b>	<b>0.22mm</b> AWG22
EL CABLEADO NO DEBE PASAR CERCA DE LA LINEA ELÉCTRICA WIRING MUST NOT BE RUN CLOSE TO THE ELECTRICAL LINE	

NO DUPLICAR CABLES Va Vb  
DON'T DUPLICATE WIRES Va Vb



✓





✗



**GESTIÓN DE ABREPUERTAS** DOOR OPENER MANAGEMENT

