

# neos

## DIGITAL

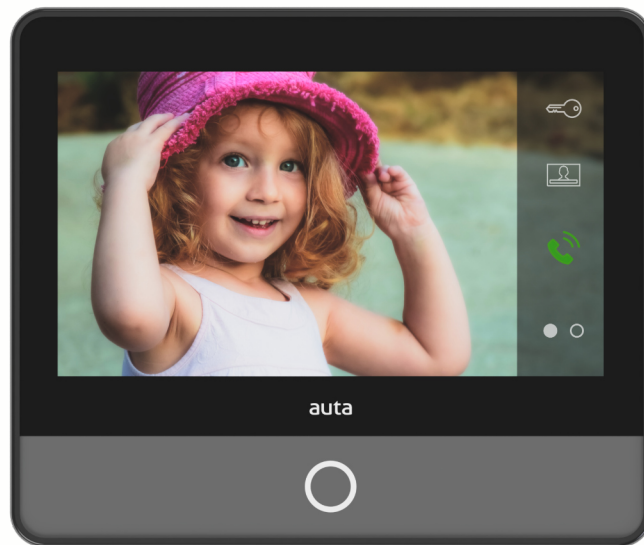

REF: **745292**

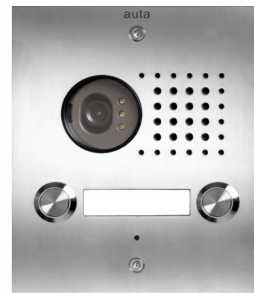

REF: **745294**

**ES** KVD-2 S1 COAX

**EN** KVD-2 S1 COAX

# auta

Bringing people together

## Elementos en el kit Elements in the kit

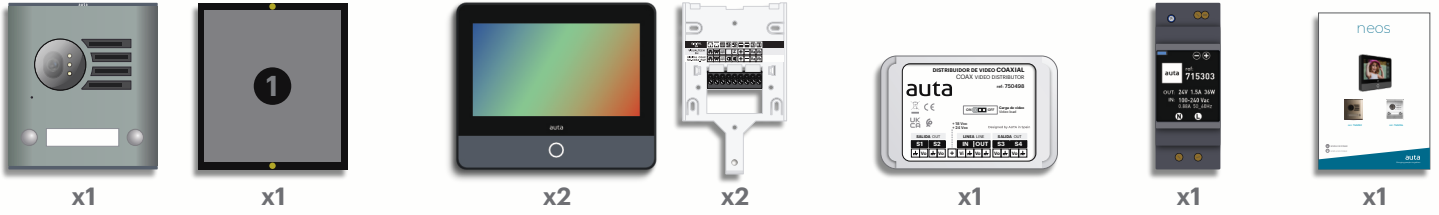

## Características Features

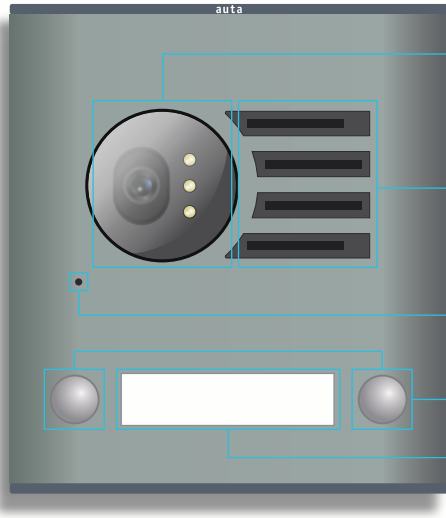

- **Módulo de video** Video module
- **Altavoz** Speaker
- **Micrófono** Microphone
- **Pulsadores de llamada** Call push-buttons
- **Tarjetero de información** Information cardholder

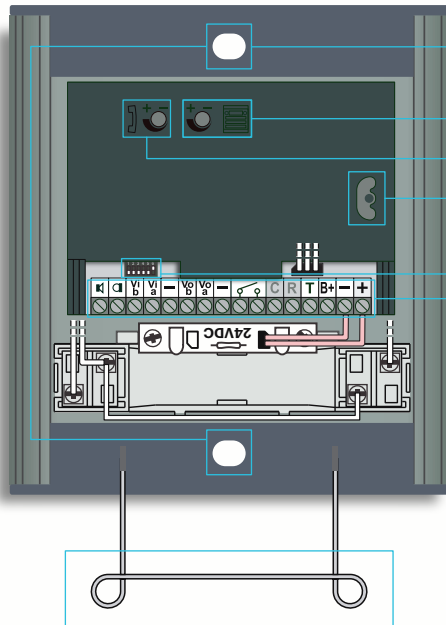

- **Orificios de fijación** Placement holes
- **Volumen de audio en placa** Panel audio volume
- **Volumen de audio en vivienda** Flat audio volume
- **Inclinación vertical de cámara ± 15°** Camera vertical inclination ± 15°
- **ID de placa (binario)** Panel ID (binary)

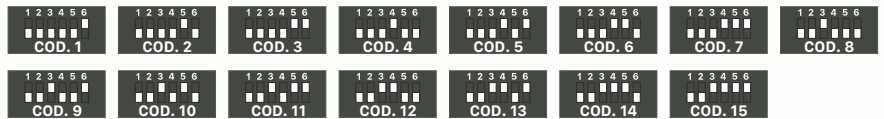

- **Conexiones** Connections

	<b>Altavoz_Datos</b>	Speaker_Data
	<b>Micrófono</b>	Microphone
<b>Vi_b</b>	<b>NO USADO</b>	NOT USED
<b>Vi_a</b>	<b>Video (entrada)</b>	Video (in)
<b>Vo_b</b>	<b>NO USADO</b>	NOT USED
<b>Vo_a</b>	<b>Video (salida)</b>	Video (out)
	<b>Relé libre de tensión N.A. _1A</b>	Free tension N.O. _1A relay
<b>T</b>	<b>Salida +12 Vcc (solo durante la llamada_conversación)</b>	Out +12 Vdc (only during the call_conversation)
<b>B+</b>	<b>Pulsador apertura (entrada -)</b>	Opening button (input -)
<b>-</b>	<b>-24 Vcc (todos iguales)</b>	-24 Vdc (all same)
<b>+</b>	<b>+24 Vcc</b>	+24 Vdc

- **Soporte de apoyo para caja de empotrar** Hook support for mounting box

## Montaje Mounting



Colocar caja de empotrar  
Place mounting box



Colocar caja de superficie  
Place surface box

1

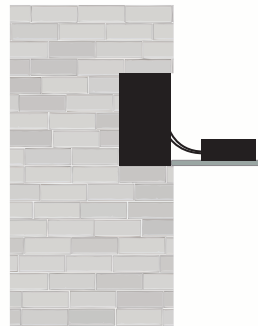

Conectar el cableado  
Connect the wiring

2

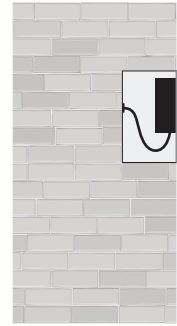

Cerrar la placa realizando una curva inferior con el cableado  
Connect the panel doing a lower curve with the wiring

3

## Colocar información en el tarjetero Place information in the cardholder

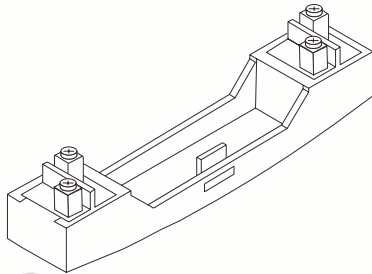

1

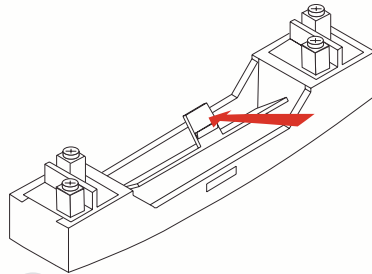

2

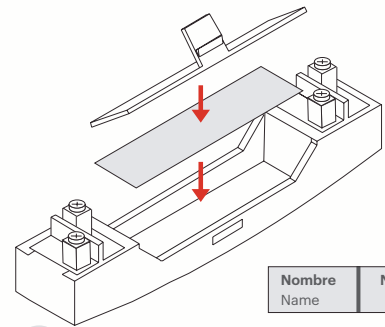

3

Nombre	Nombre
Name	Name

## Instalación Installation

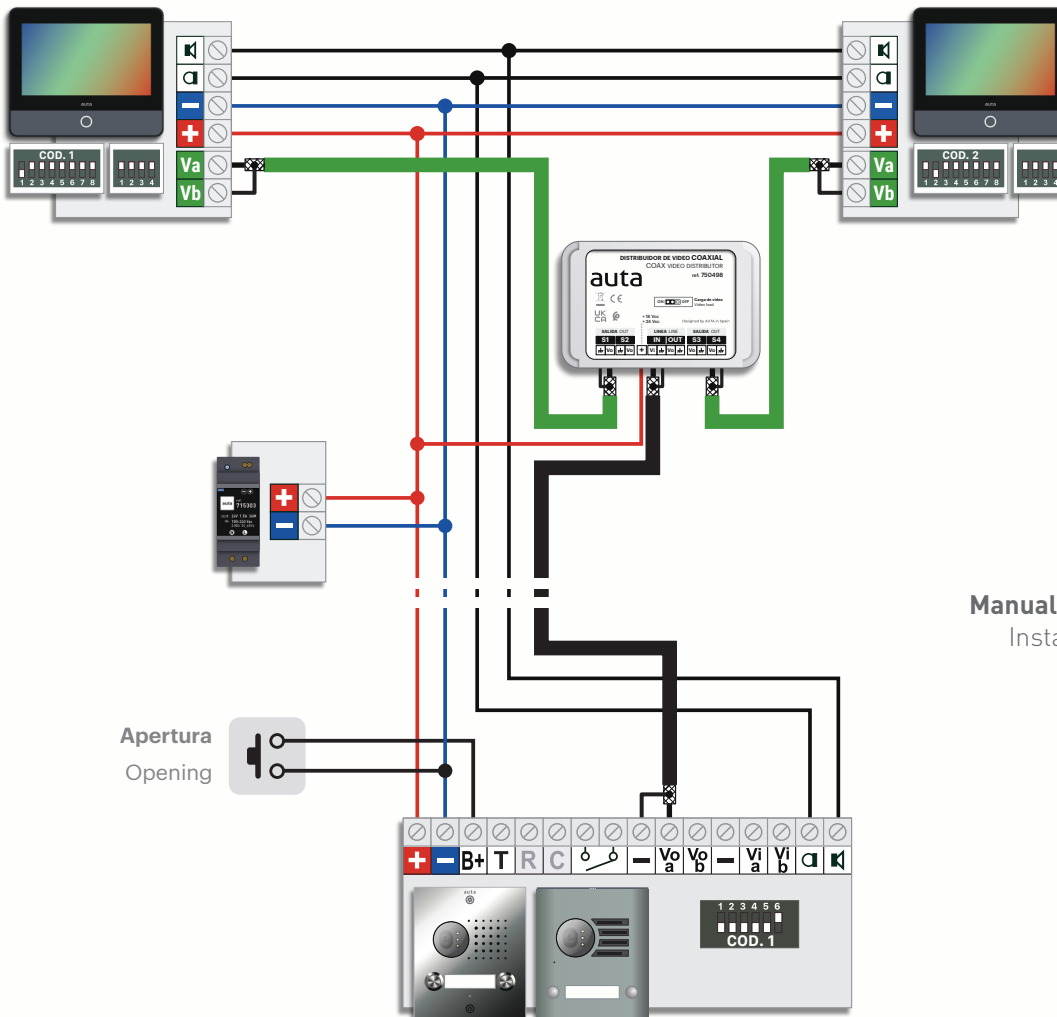



Manual de instalación VIDEO COAXIAL  
Installation manual VIDEO COAX

## Nº MÁXIMO DE ELEMENTOS MAX. NUMBER OF ELEMENTS

ELEMENTOS UNITS	ALV-1.5A (715303)	ALV-2.5A (715703)
 <b>LLAMADA SIMULTANEA</b> SIMULTANEOUS CALL	<b>3</b>	<b>5</b>

## SECCIONES Y CONEXIONES RECOMENDADAS RECOMMENDED SECTIONS AND CONNECTIONS

SECCIONES WIRING SECTIONS	HASTA 100m UP TO 100m	HASTA 200m UP TO 200m
+ -	1mm AWG17	1.5mm AWG15
 	0.5mm AWG20	1mm AWG17
<b>COAXIAL</b>	<b>RG-59 75Ω</b>	
EL CABLEADO NO DEBE PASAR CERCA DE LA LINEA ELÉCTRICA WIRING MUST NOT BE RUN CLOSE TO THE ELECTRICAL LINE		

## GESTIÓN DE ABREPUERTAS DOOR OPENER MANAGEMENT

