

neos

DIGITAL

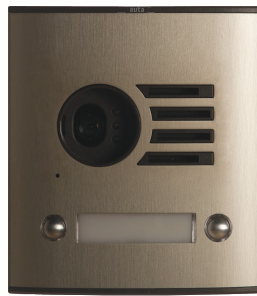

REF. 745102



REF. 745142



REF. 745122



REF. 745162

ES KVD-2 S1 VISUALTECH 5H

EN KVD-2 S1 VISUALTECH 5W

Elementos en el kit Elements in the kit



x1

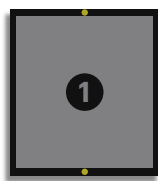

x1

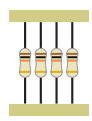

4 x 10K



x2



x2

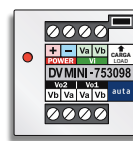

x1



x1



x1

Características Features

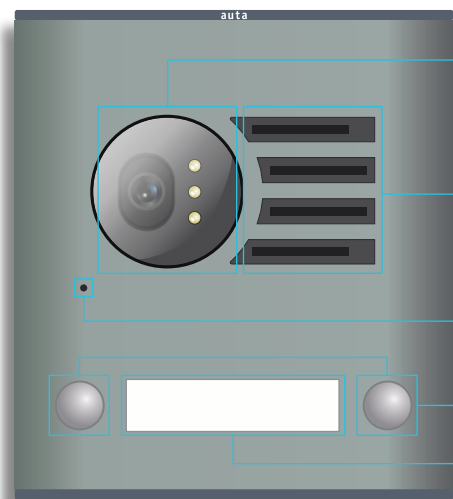

- **Módulo de video** Video module
- **Altavoz** Speaker
- **Micrófono** Microphone
- **Pulsadores de llamada** Call push-buttons
- **Tarjetero de información** Information cardholder

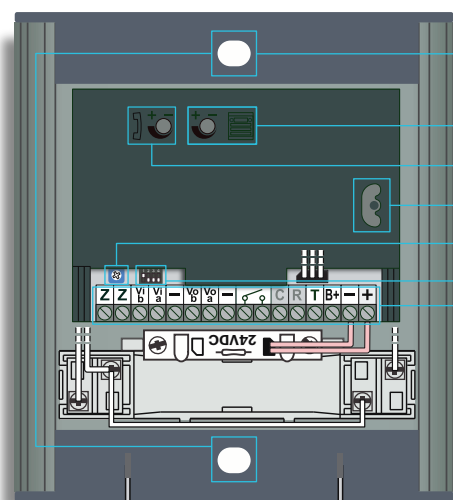

- **Orificios de fijación** Placement holes
- **Volumen de audio en placa** Panel audio volume
- **Volumen de audio en vivienda** Flat audio volume
- **Inclinación vertical de cámara ± 15°** Camera vertical inclination ± 15°
- **Ajuste de balance (elimina acoplamiento en audio)** Balance adjust (removes audio feedback)
- **ID de placa (binario)** Panel ID (binary)



- **Conexiones** Connections

Z	Audio_Datos	Audio_Data
Vi_b	Video - (entrada)	Video - (in)
Vi_a	Video + (entrada)	Video + (in)
Vo_b	Video - (salida)	Video - (out)
Vo_a	Video + (salida)	Video + (out)
⚡	Relé libre de tensión N.A. _1A	Free tension N.O. _1A relay
T	Salida +12 Vcc (solo durante la llamada_conversación)	Out +12 Vdc (only during the call_conversation)
B+	Pulsador apertura (entrada -)	Opening button (input -)
-	-24 Vcc (todos iguales)	-24 Vdc (all same)
+	+24 Vcc	+24 Vdc

- **Soporte de apoyo para caja de empotrar** Hook support for mounting box

Montaje Mounting

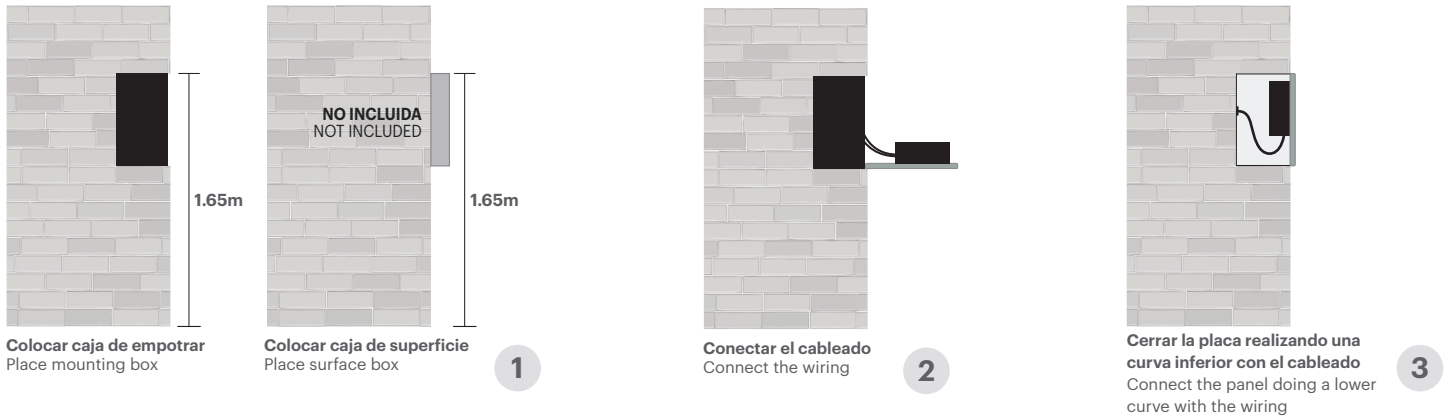

Colocar información en el tarjetero Place information in the cardholder

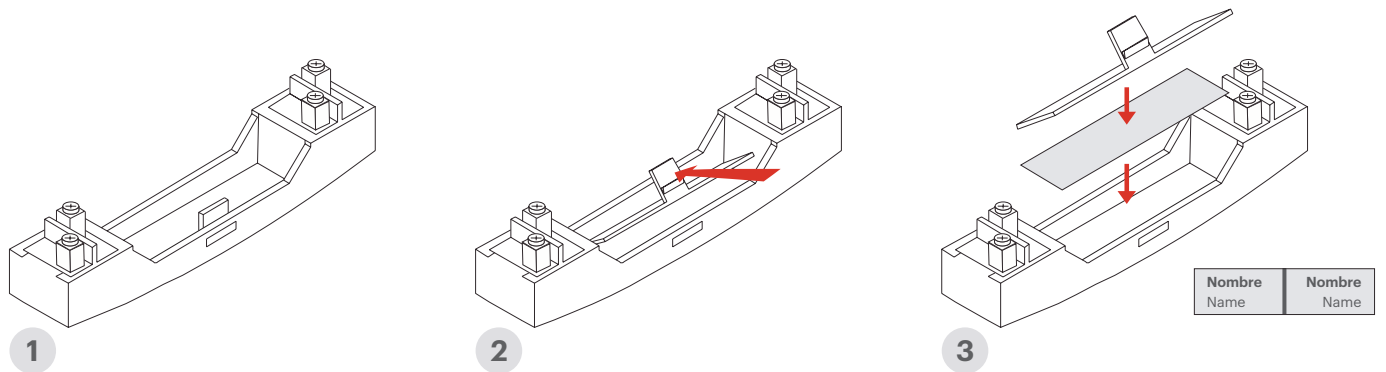

Instalación Installation

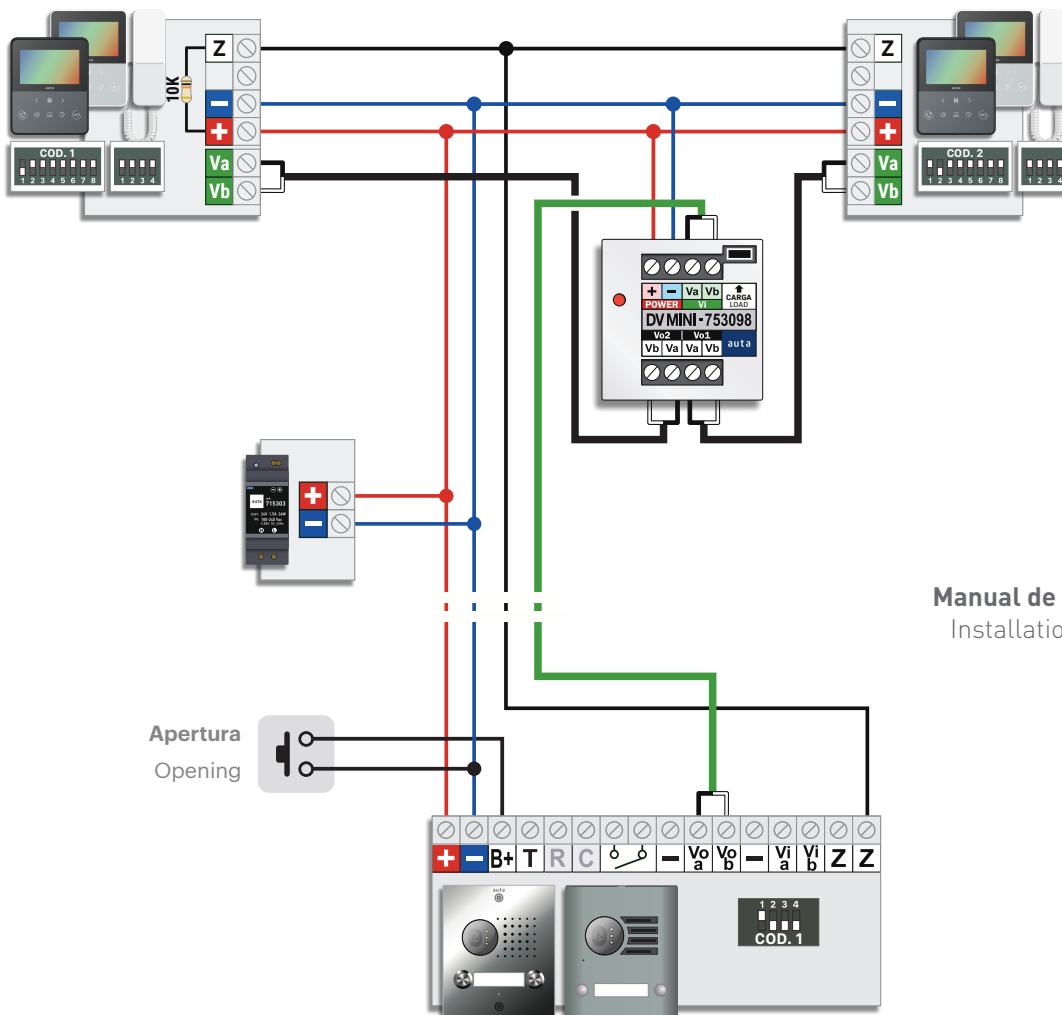





Manual de instalación VIDEO VISUALTECH 5H
Installation manual VIDEO VISUALTECH 5W

Nº MÁXIMO DE ELEMENTOS MAX. NUMBER OF ELEMENTS

ELEMENTOS UNITS	ALV-1.5A (715303)	ALV-2.5A (715703)
 LLAMADA SIMULTANEA SIMULTANEOUS CALL	3	5

SECCIONES Y CONEXIONES RECOMENDADAS RECOMMENDED SECTIONS AND CONNECTIONS

	CAT 5/6/FTP	AUTA
par NARANJA ORANGE pair		+
par VERDE GREEN pair		-
cable AZUL_BLANCO BLUE_WHITE wire		Va
cable AZUL BLUE wire		Vb
par MARRÓN BROWN pair		Z
100% COBRE 100% COPPER		

SECCIONES WIRING SECTIONS	HASTA 100m UP TO 100m
+ - Z Va Vb	0.22mm AWG22
EL CABLEADO NO DEBE PASAR CERCA DE LA LINEA ELÉCTRICA WIRING MUST NOT BE RUN CLOSE TO THE ELECTRICAL LINE	

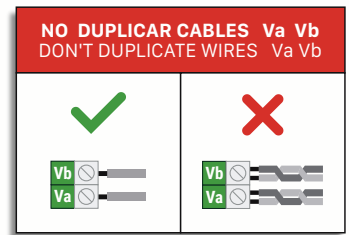

GESTIÓN DE ABREPUERTAS DOOR OPENER MANAGEMENT

