

# neos

## DIGITAL



REF: 743010



REF: 743012



REF: 743040



REF: 743042

ES KVD-2 S1 COAX

EN KVD-2 S1 COAX

auta

Bringing people together

## Desmontaje del perfil Profile disassembly

PARA UNA MAYOR COMODIDAD REALIZAR EL PROCESO USANDO UNA SUPERFICIE DE APOYO.

FOR GREATER COMFORT, PERFORM THE PROCESS USING A SUPPORT SURFACE.

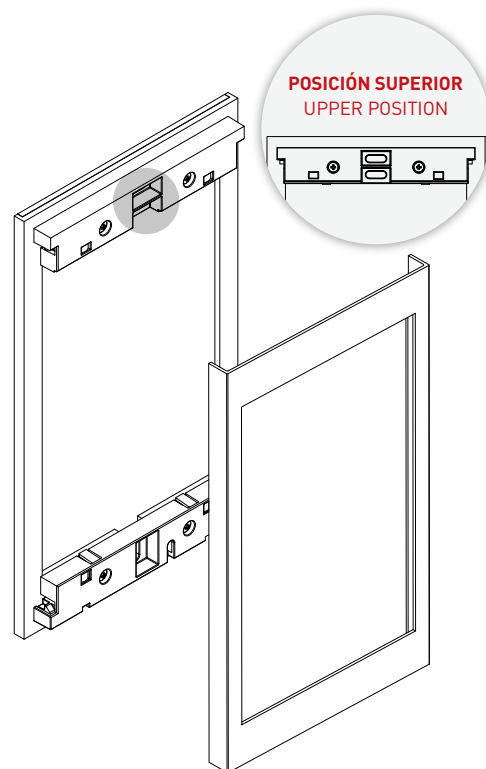
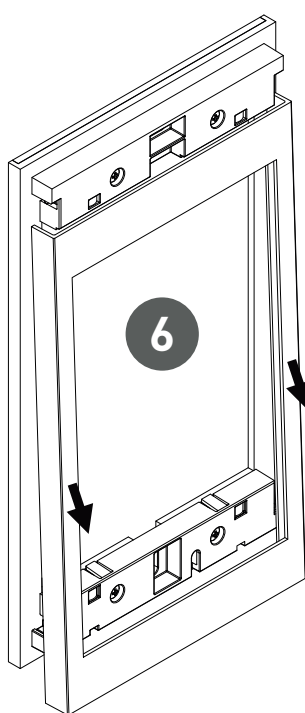
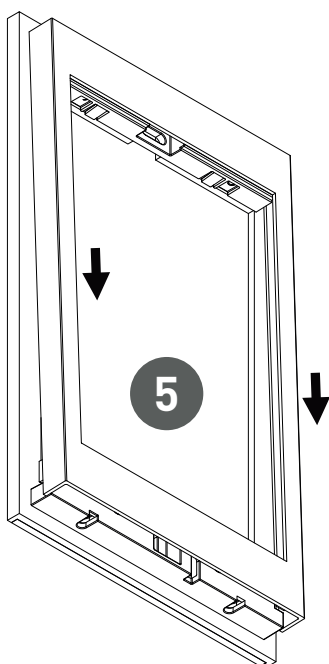
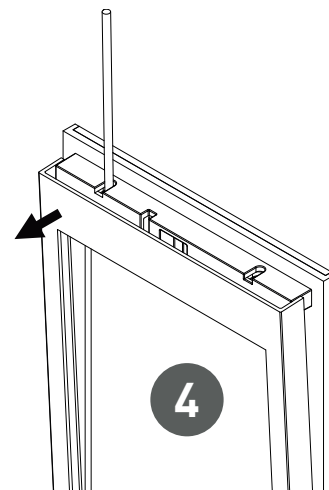
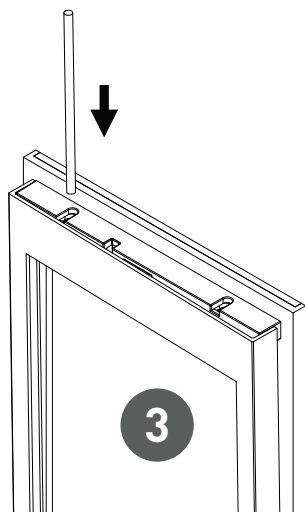
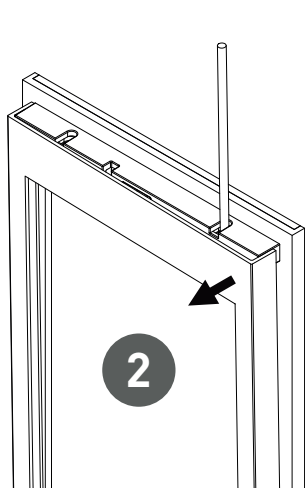
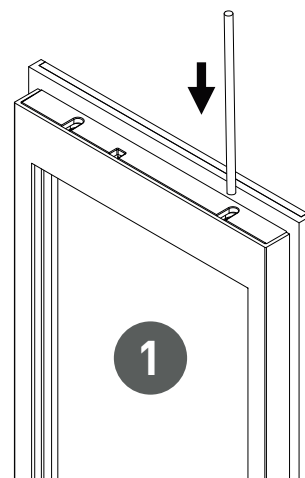
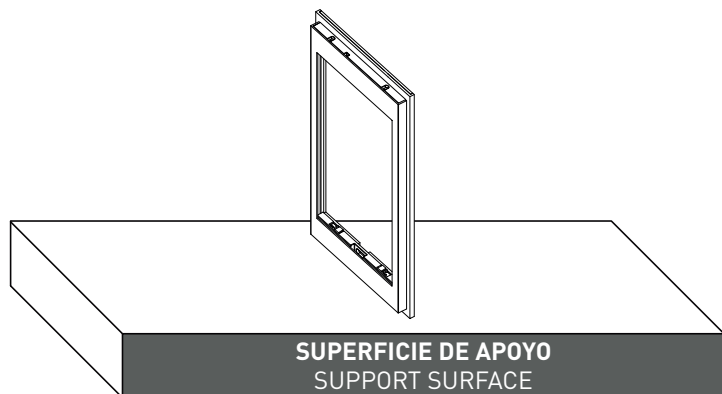

## Elementos en el kit Elements in the kit

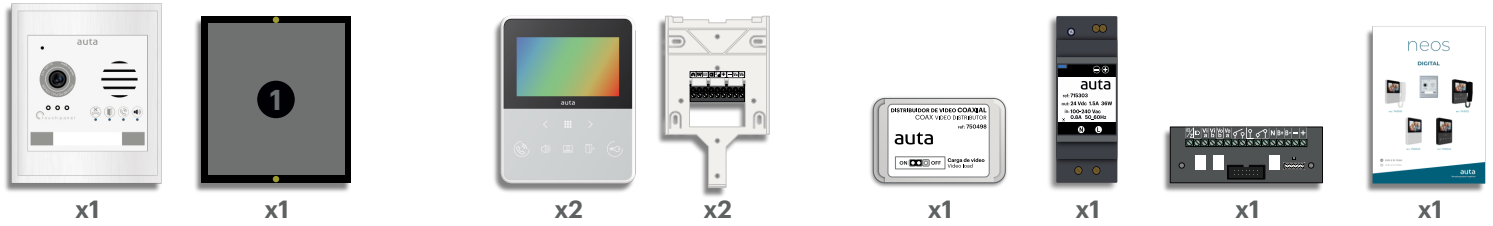

## Colocar información en tarjetero Place information in card holder

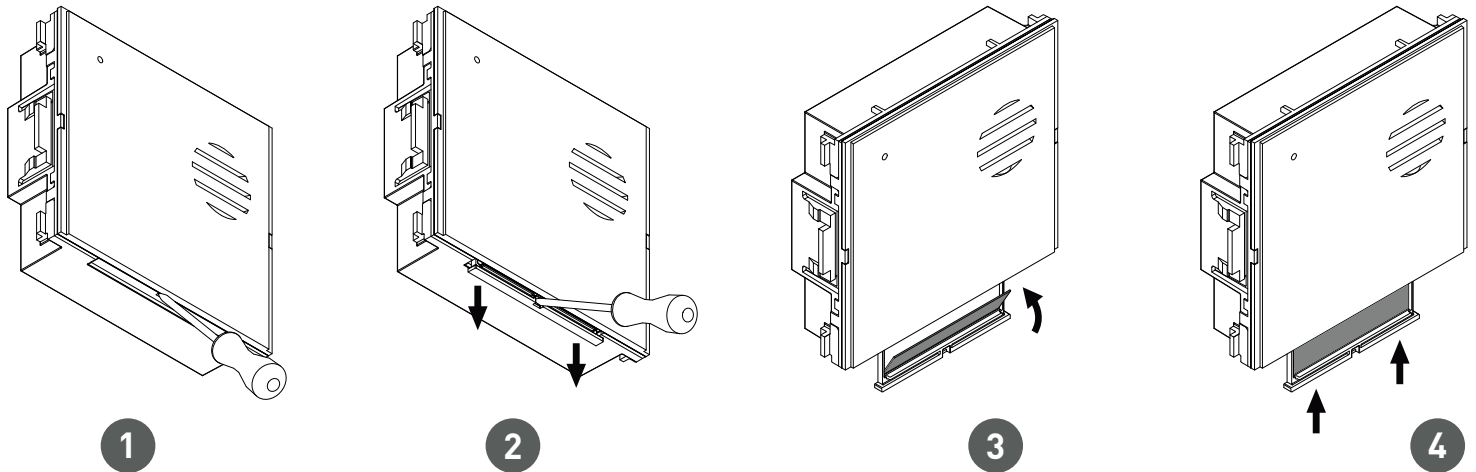

## Descripción Description

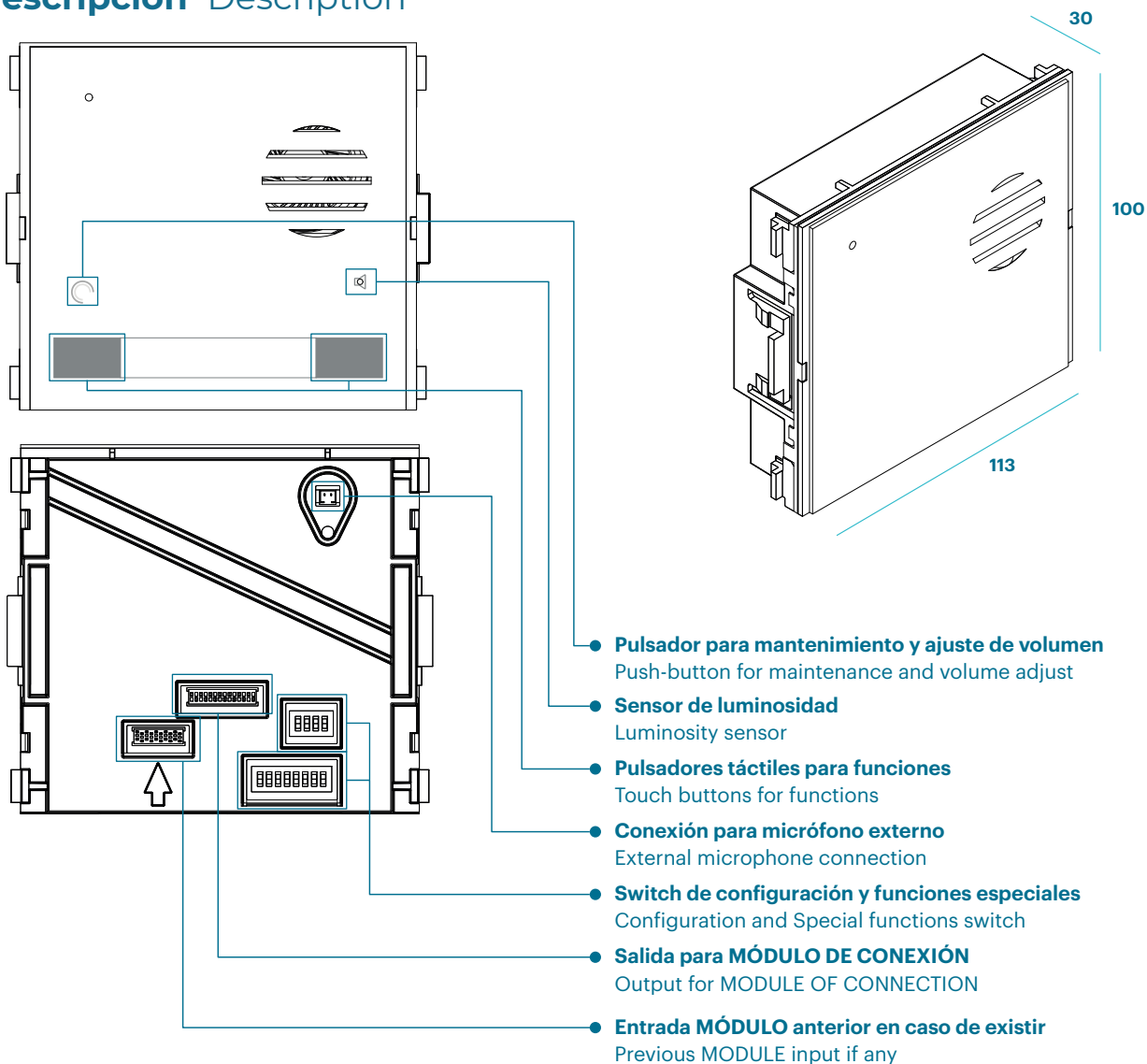

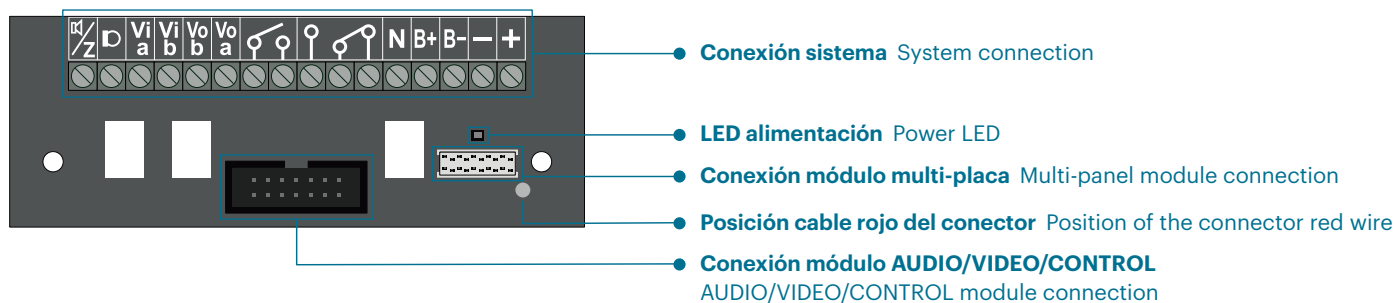

|             |  |  |
|-------------|--|--|
| <b>Z</b>    | <b>Audio_Datos</b>   | Audio_Data   |
| <b>D</b>    | <b>Micrófono (solo sistema digital)</b>                                      | Microphone (only digital system)                                 |
| <b>Vi_a</b> | <b>Video + (entrada)</b>   | Video + (in)   |
| <b>Vi_b</b> | <b>Video - (entrada)</b>   | Video - (in)   |
| <b>Vo_b</b> | <b>Video - (salida)</b>  | Video - (out)  |
| <b>Vo_a</b> | <b>Video + (salida)</b>  | Video + (out)  |
|             | <b>Relé libre de tensión N.A. _1A</b>  | Free tension N.O. _1A relay                                      |
|             | <b>Relé libre de tensión N.A. - N.C. _1A</b>                                 | Free tension N.O. - N.C. _1A relay                               |
| <b>N</b>    | <b>Salida NEGATIVO PARA MANIOBRAS (solo durante la llamada_conversación)</b> | NEGATIVE out for managements (only during the call_conversation) |
| <b>B+</b>   | <b>Pulsador apertura (terminal 1)</b>  | Opening button (terminal 1)                                      |
| <b>B-</b>   | <b>Pulsador apertura (terminal 2)</b>  | Opening button (terminal 2)                                      |
| <b>-</b>    | <b>-24 Vcc</b>   | -24 Vdc  |
| <b>+</b>    | <b>+24 Vcc</b>   | +24 Vdc  |

## Instalación Installation

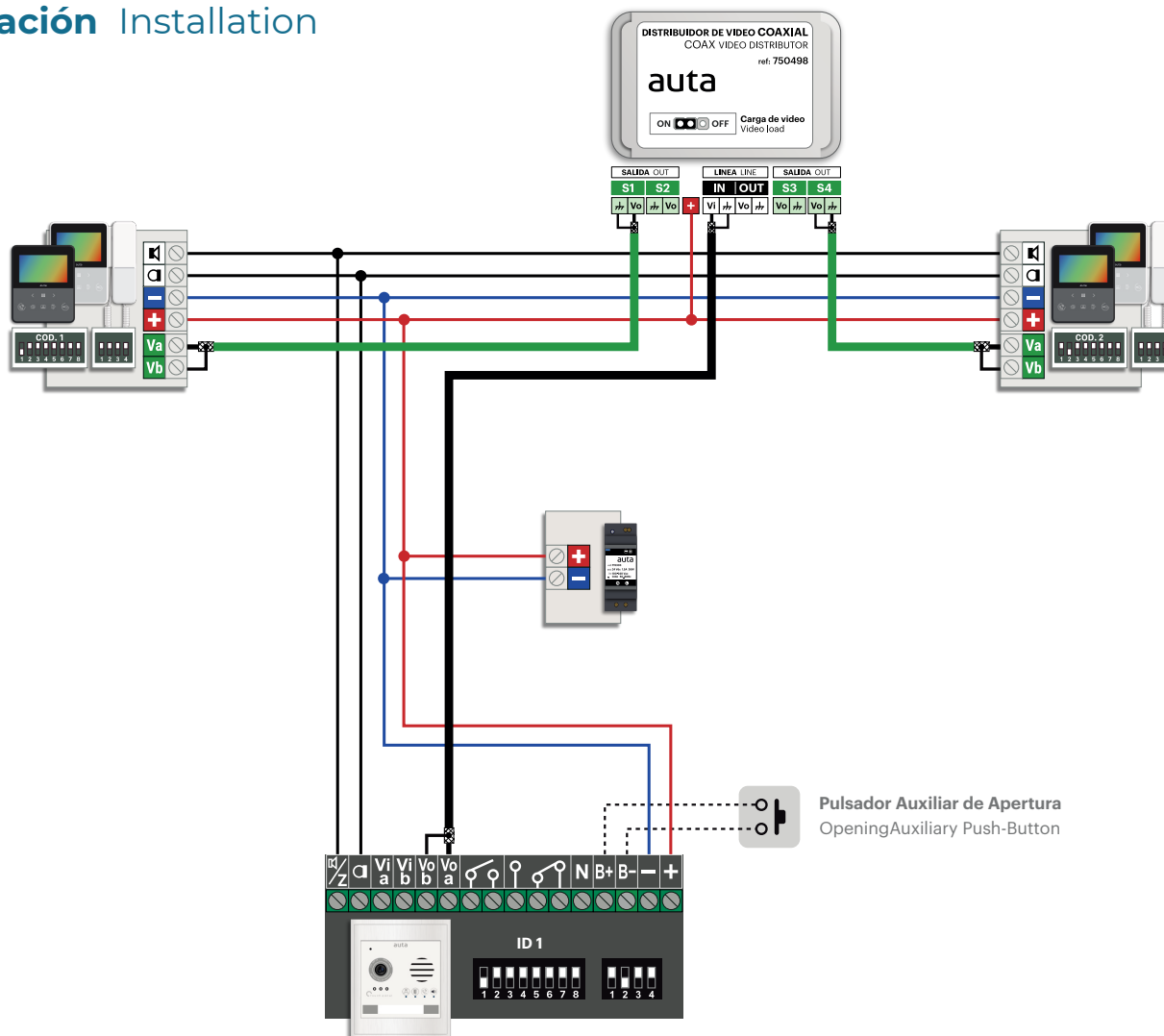

# Configuración Configuration

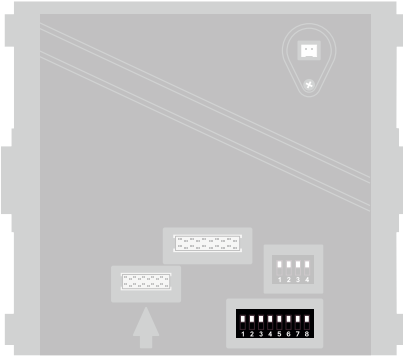

**Configuración de ID de placa**  
Panel ID configuration

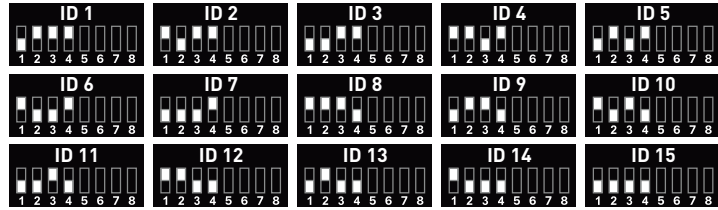

**AUTO-ENCENDIDO a placa**  
SELF-STARTING to panel



**Llamada a CONSERJERÍA**  
Call to CONCIERGE



**Relé 2**  
Relay 2



**Mensaje "PUERTA ABIERTA"**  
"DOOR OPEN" message

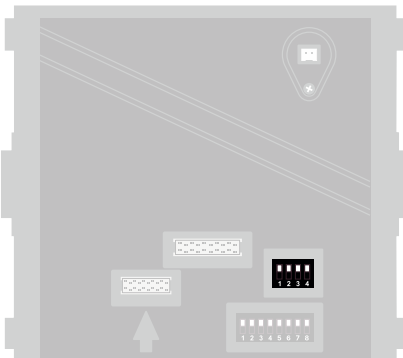

**Selección PRINCIPAL \_ SECUNDARIO**  
MASTER \_ SLAVE selection



**!** Sistema VISUALTECH SIEMPRE OFF  
VISUALTECH system ALWAYS OFF









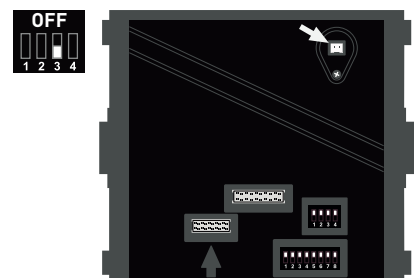
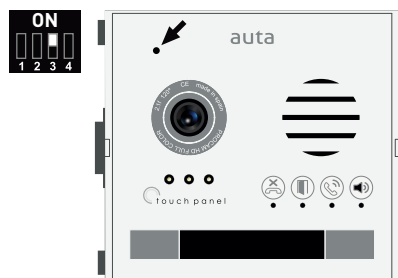





































**Selección de LLAMADA**  
CALL selection



**Selección de MICRÓFONO**  
MICROPHONE selection



## Funciones especiales Special functions

| PASOS<br>STEPS | FUNCIÓN<br>FUNCTION  | BINARIO<br>BINARY  |
|----------------|--|--|
| 1º             | Alimentar el módulo<br>Supply the module   |  |
| 2º             | Anotar configuración del módulo<br>Write down module settings  |  |
| 3º             | Entrar en modo programación<br>Enter in programming mode<br> LEDS ON                          |  LEDS ON   |
| 4º             | Configurar el código o códigos de función (tabla)<br>Set the desired function code or codes (table)  |  |
| 1              | <b>Re-assignar código de llamada pulsador IZQUIERDA (defecto código 1)</b><br>Re-assign calling code to LEFT PUSH-BUTTON (default code 1)                                      |  →  →  →  →  →              |
| 2              | <b>Re-assignar código de llamada pulsador DERECHA</b><br>Re-assign calling code to RIGHT PUSH-BUTTON   |  →  →  →  →  →              |
| 3              | <b>Re-assignar tiempo de apertura 1, vivienda (defecto 2 segundos)</b><br>Re-assign opening time 1, flat (default 2 seconds)   |  →  →  →  →  →  |
| 4              | <b>Re-assignar tiempo de apertura 2, pulsador externo y código (defecto 5 segundos)</b><br>Re-assign opening time 2, external button and code (default 5 seconds)              |  →  →  →  →  →  |
| 6              | <b>Placa configurada como EXTERIOR (bus X SDL) (habilitar llamada a conserjería)</b><br>Panel configured as EXTERNAL (X SDL bus) (activate concierge call)                     |  →  →    |
| 7              | <b>Código de SDL al que llamará P1 (el cod. de vivienda será el asignado en la func. 1)</b><br>SDL code where P1 will call (House code will be the one assigned in function 1) |  →  →  →  →  →  |
| 8              | <b>Código de SDL al que llamará P2 (el cod. de vivienda será el asignado en la func. 2)</b><br>SDL code where P2 will call (House code will be the one assigned in function 2) |  →  →  →  →  →  |
| 9              | <b>Placa configurada como INTERIOR (anula función 6)</b><br>Panel configured as INTERNAL (disable func. 6)   |  →  →    |



## Funciones especiales Special functions

|     |   |  |
|-----|---|--|
| 129 | <b>Mensaje "Puerta abierta" en ESPAÑOL</b><br>"Door open" message in SPANISH      |  |
| 130 | <b>Mensaje "Puerta abierta" en CATALÁN</b><br>"Door open" message in CATALAN      |  |
| 131 | <b>Mensaje "Puerta abierta" en INGLÉS</b><br>"Door open" message in ENGLISH       |  |
| 132 | <b>Mensaje "Puerta abierta" en PORTUGUÉS</b><br>"Door open" message in PORTUGUESE |  |
| 133 | <b>Mensaje "Puerta abierta" en FRANCÉS</b><br>"Door open" message in FRENCH       |  |
| 255 | <b>Valores de fábrica</b><br>Factory settings                                     |  |

5°

Salir del modo programación



Exit of programming mode



6°

Restablecer configuración del módulo (paso 2°)

Restore the module configuration (step 2°)

## Ajuste de volumen Volume adjust

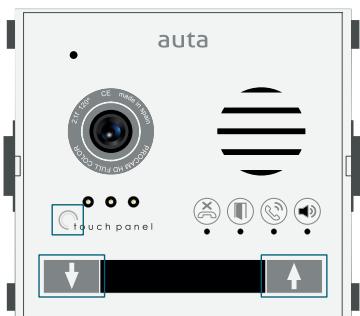

### Entrar en modo ajuste de volumen Enter in volume adjust mode

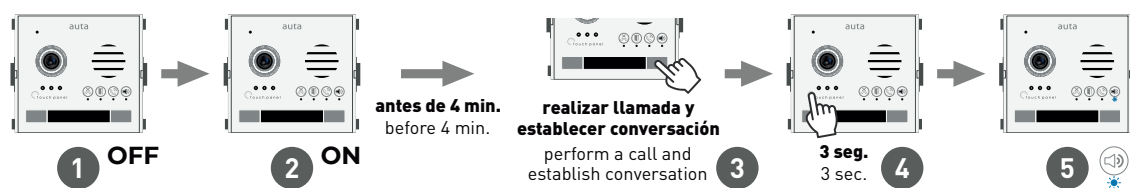

Existen 3 parámetros en los que podemos realizar ajustes de volumen:

1. Volumen de AUDIO en PLACA
2. Volumen de AUDIO en VIVIENDA
3. Volumen de AUDIO en mensaje "PUERTA ABIERTA"

Disponemos de 8 niveles de audio seleccionables, representados por 4 LEDS azules. Cada led indica 2 niveles.

There are 3 parameters in which we can make volume adjustments:

1. AUDIO volume at PANEL
2. AUDIO volume at HOUSING
3. AUDIO volume for "DOOR OPEN" message

We have 8 selectable audio levels, represented by 4 blue LEDs. Each led indicates 2 levels.



## Modo mantenimiento Maintenance mode

El modo mantenimiento es un modo en el que la placa desactiva todos sus módulos conectados por seguridad, así se pueden realizar procedimientos tales como limpieza o la colocación de información en los tarjeteros de los pulsadores, con total seguridad.

El tiempo máximo en el que la placa permanece en modo mantenimiento es de 4 minutos. Pasado este tiempo se deberá re-armar.

The maintenance mode is a mode in which the panel deactivates all its connected modules for safety reasons, so procedures such as cleaning or placing information in the button card holders, can be carried out in complete safety.

The maximum time that the panel remains in maintenance mode is 4 minutes. After this time, it must be re-armed.

### Entrar en modo mantenimiento Enter in maintenance mode

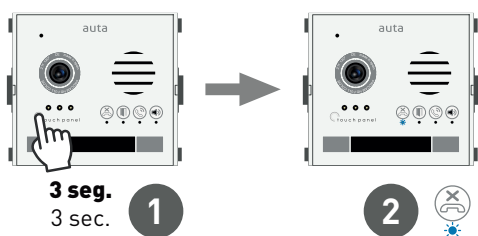



## Montaje Mounting

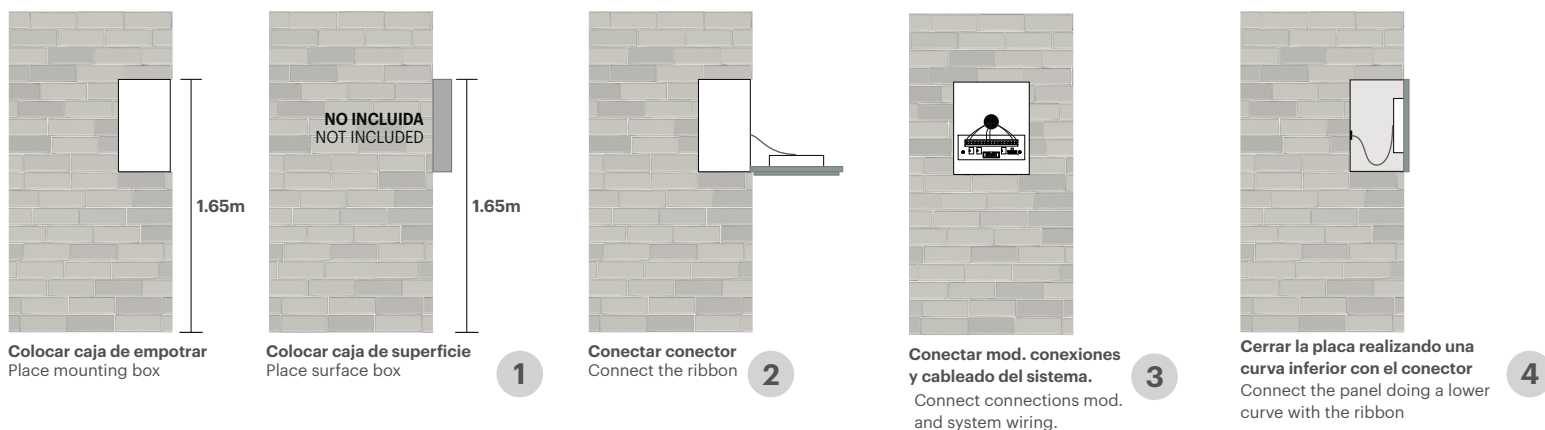

## Montaje del perfil Profile assembly

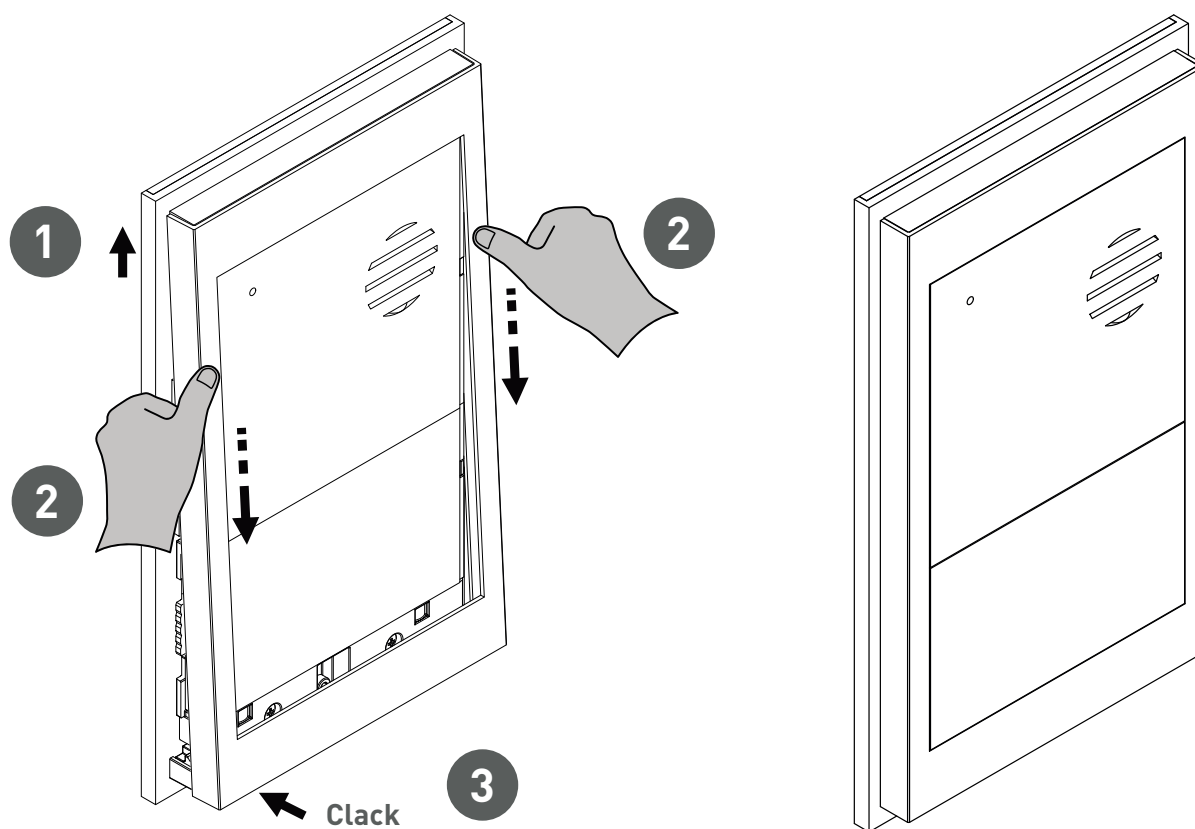

| ELEMENTOS UNITS                      | ALV-1.5A (715303) | ALV-2.5A (715703) |
|--------------------------------------|-------------------|-------------------|
|                                      | 30                | 30                |
|                                      | 50                | 100               |
| LLAMADA SIMULTANEA SIMULTANEOUS CALL | 3                 | 5                 |

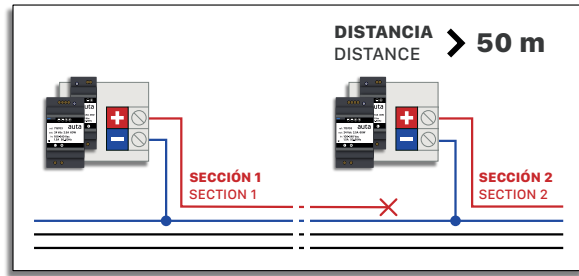

SECCIONES RECOMENDADAS RECOMMENDED SECTIONS



SI EL CABLEADO ESTÁ A MENOS DE 20cm DE LA LÍNEA ELÉCTRICA SE RECOMIENDA QUE SEA APANTALLADO. SE UNIRÁN TODAS LAS PANTALLA ENTRE SI Y SE CONECTARÁN, EN UN PUNTO INTERMEDIO, A TOMA DE TIERRA (VERDE-AMARILLO).

IF THE WIRING IS LESS THAN 20cm FROM THE ELECTRICAL LINE, IS RECOMMENDED IT TO BE SHIELDED. ALL THE SHIELDS WILL BE LINKED TO EACH OTHER AND CONNECTED, AT AN INTERMEDIATE POINT, TO GROUND (GREEN-YELLOW).

| SECCIONES CABLE WIRE SECTIONS |             |
|-------------------------------|-------------|
| + -                           | 1mm AWG17   |
| COAXIAL                       | RG-59 75Ω   |
| 100% COBRE                    | 100% COPPER |

CONFIGURACIÓN DE VIDEO VIDEO CONFIGURATION

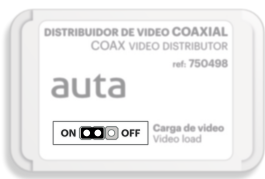

COLOCAR LA CARGA "OFF" EN TODOS LOS DISTRIBUIDORES DE LA MISMA LINEA EXCEPTO EN EL ÚLTIMO.

SET THE LOAD "OFF" AT ALL VIDEO DISTRIBUTORS IN THE SAME LINE EXCEPT AT LAST ONE.

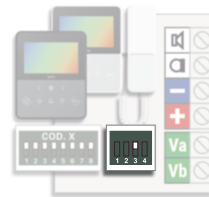

EN SISTEMAS CON DISTRIBUCION EN CASCADA COLOCAR EL SWITCH 3 ABAJO (OFF) EN TODOS LOS MONITORES DE LA MISMA LINEA EXCEPTO EN EL ÚLTIMO.

AT SYSTEMS WITH SERIAL DISTRIBUTION SET THE SWITCH 3 DOWN (OFF) AT ALL MONITORS IN THE SAME LINE EXCEPT AT THE LAST ONE.

GESTIÓN DE ABREPUERTAS DOOR OPENER MANAGEMENT

