

# slim

## DIGITAL

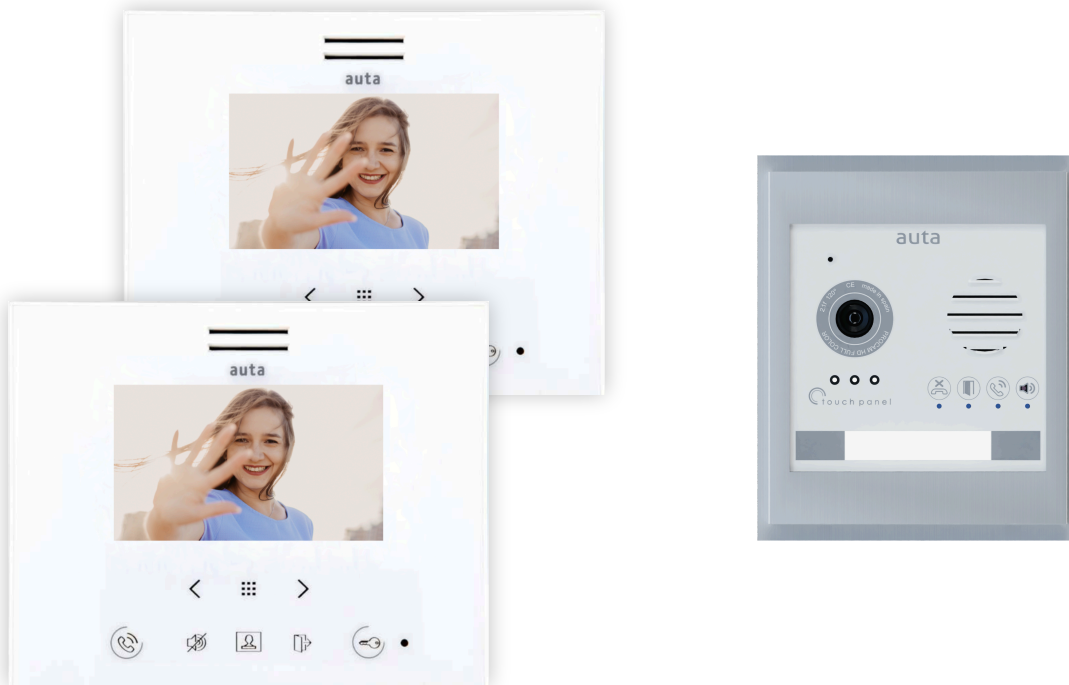

REF: 743066

**ES** KVD-2 S1 VISUALTECH 5H

**EN** KVD-2 S1 VISUALTECH 5W

**auta**

Bringing people together

## Desmontaje del perfil Profile disassembly

PARA UNA MAYOR COMODIDAD REALIZAR EL PROCESO USANDO UNA SUPERFICIE DE APOYO.

FOR GREATER COMFORT, PERFORM THE PROCESS USING A SUPPORT SURFACE.

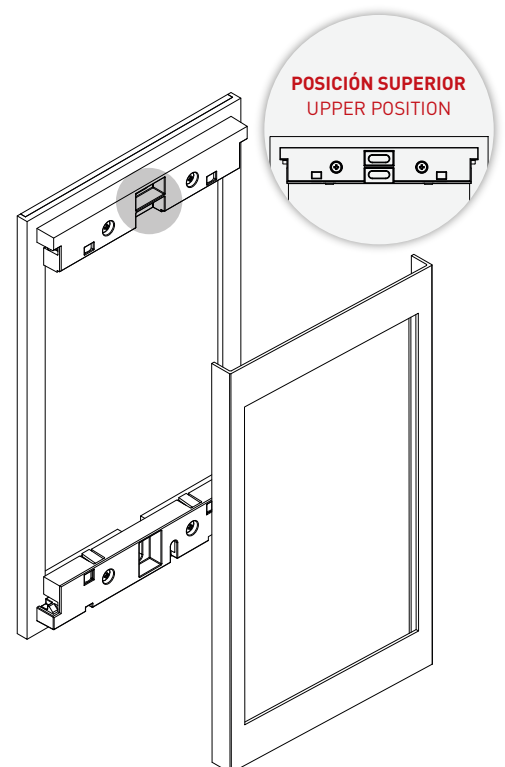
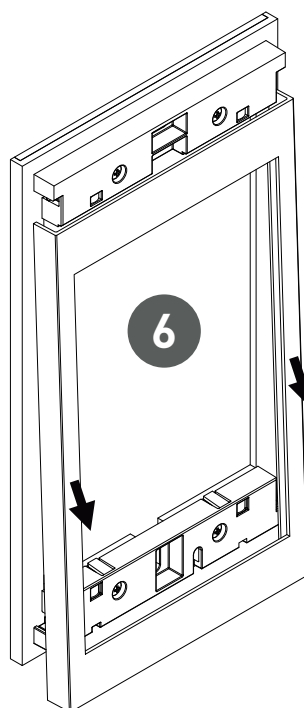
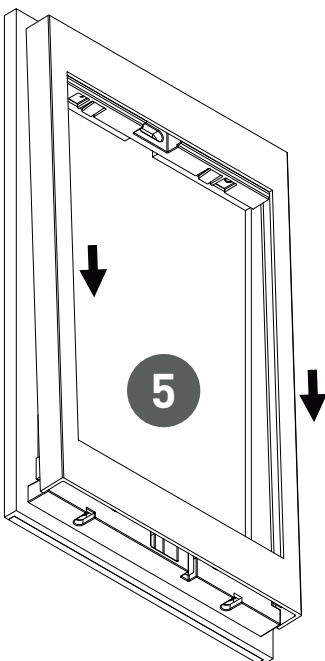
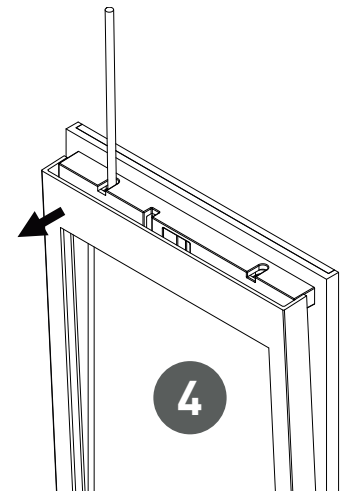
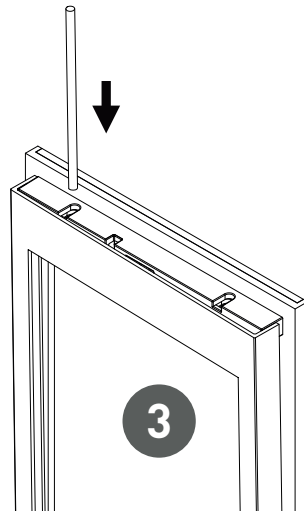
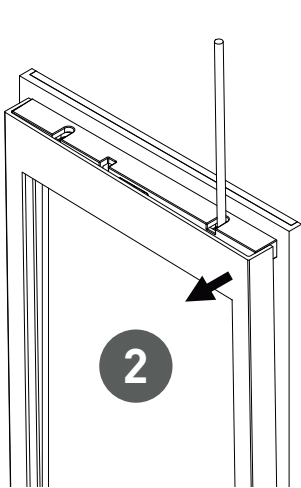
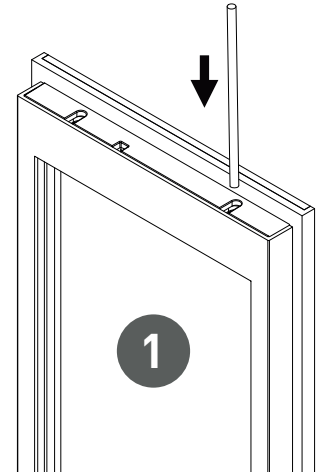
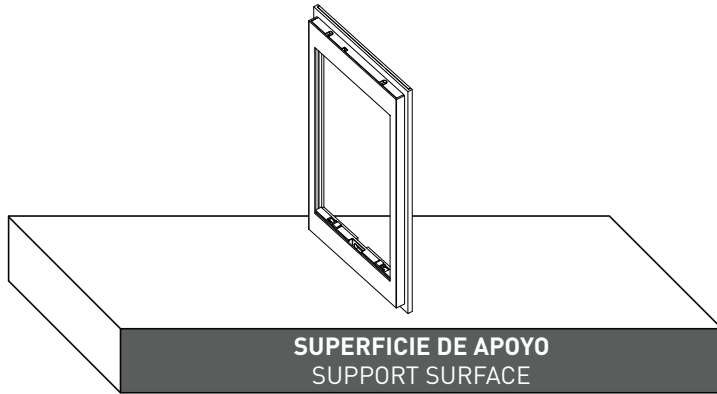

## Elementos en el kit Elements in the kit

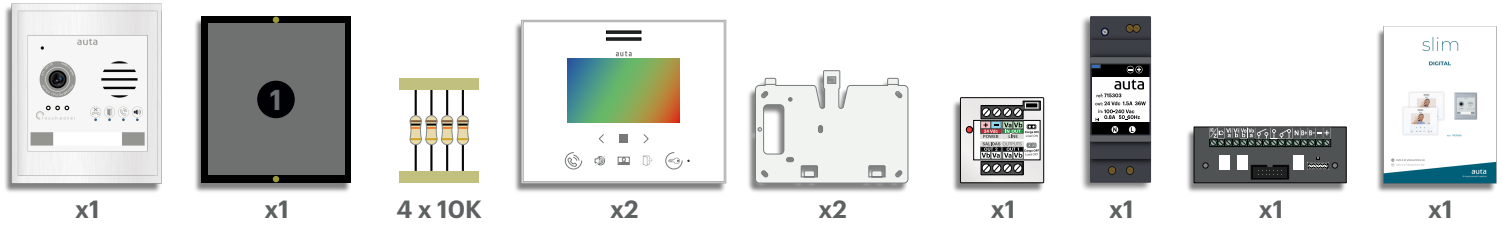

## Colocar información en tarjetero Place information in card holder

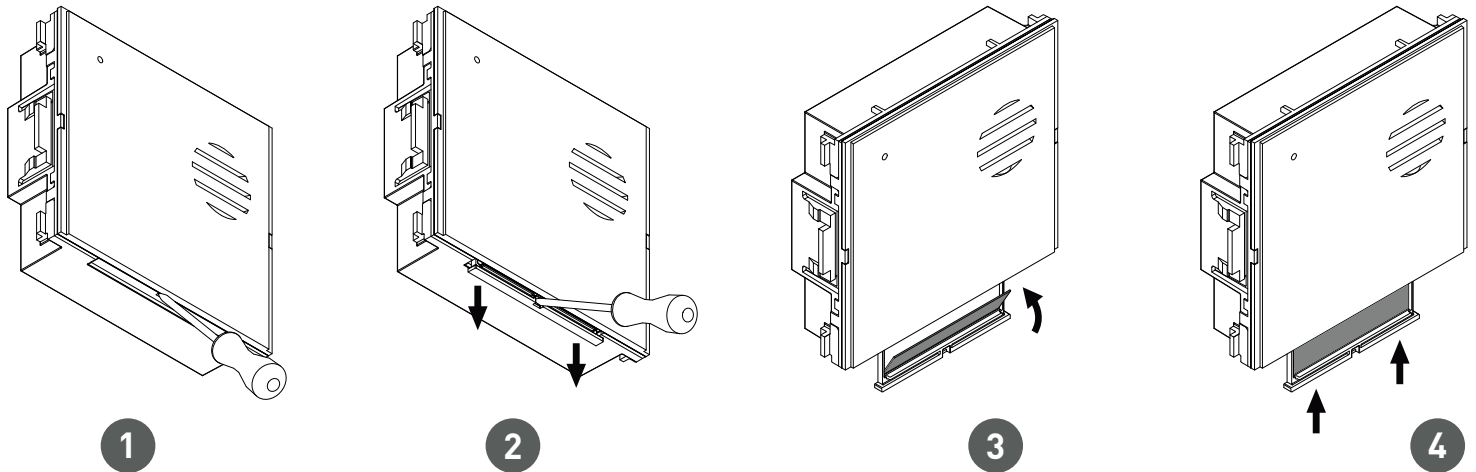

## Descripción Description

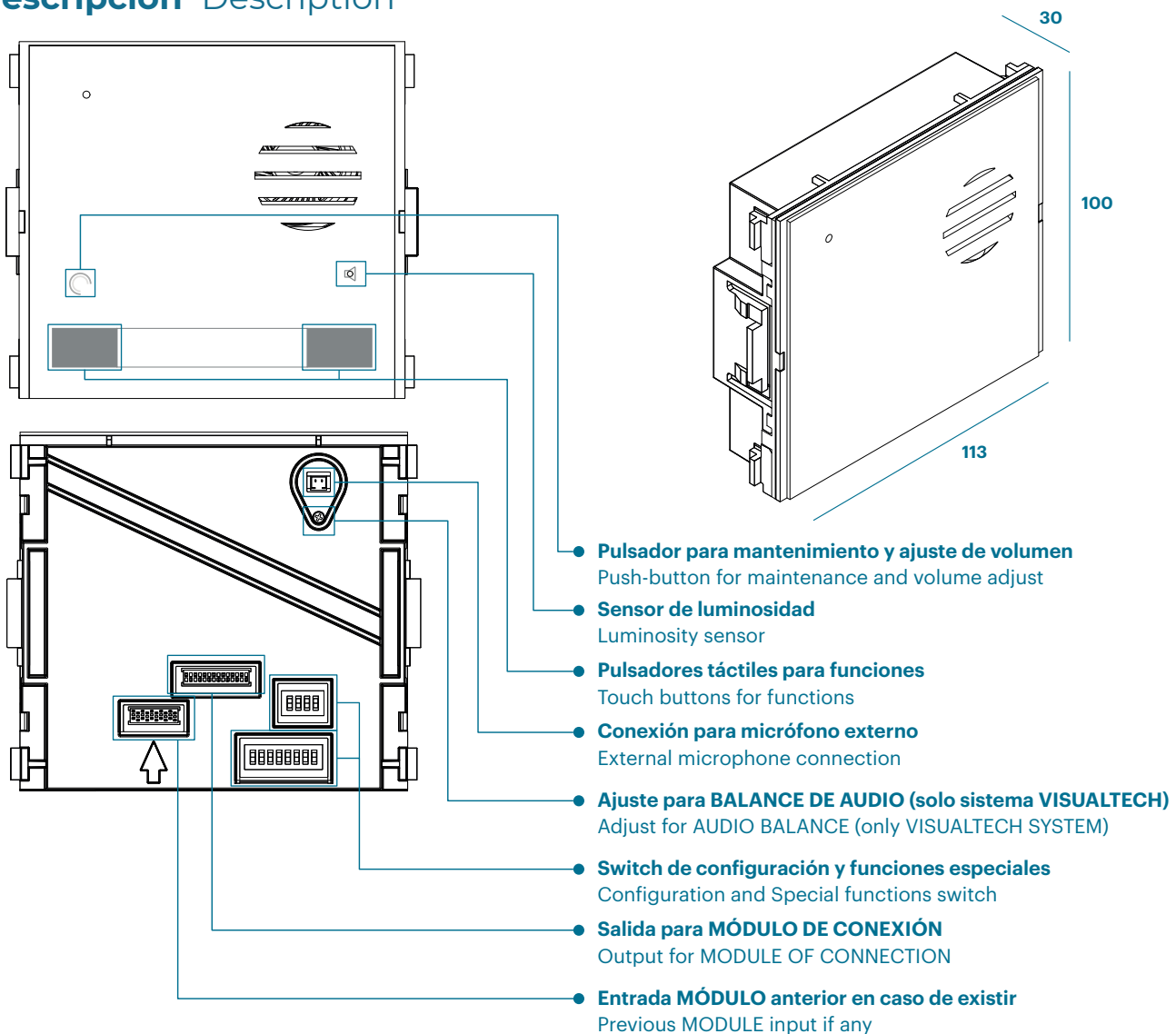

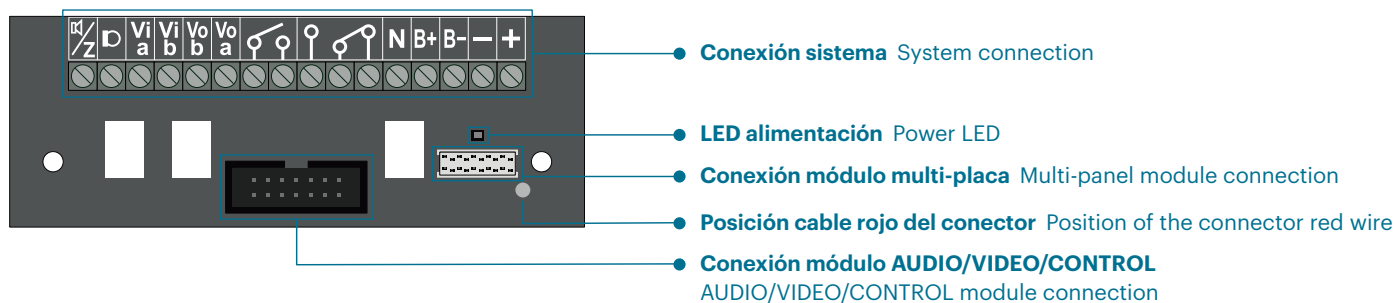

Z	Audio_Datos	Audio_Data
D	Micrófono (solo sistema digital)	Microphone (only digital system)
Vi_a	Video + (entrada)	Video + (in)
Vi_b	Video - (entrada)	Video - (in)
Vo_b	Video - (salida)	Video - (out)
Vo_a	Video + (salida)	Video + (out)
Relé libre de tensión N.A. _1A	Free tension N.O. _1A relay	
Relé libre de tensión N.A. - N.C. _1A	Free tension N.O. - N.C. _1A relay	
N	Salida NEGATIVO PARA MANIOBRAS (solo durante la llamada_conversación)	NEGATIVE out for managements (only during the call_conversation)
B+	Pulsador apertura (terminal 1)	Opening button (terminal 1)
B-	Pulsador apertura (terminal 2)	Opening button (terminal 2)
-	-24 Vcc	-24 Vdc
+	+24 Vcc	+24 Vdc

## Instalación Installation

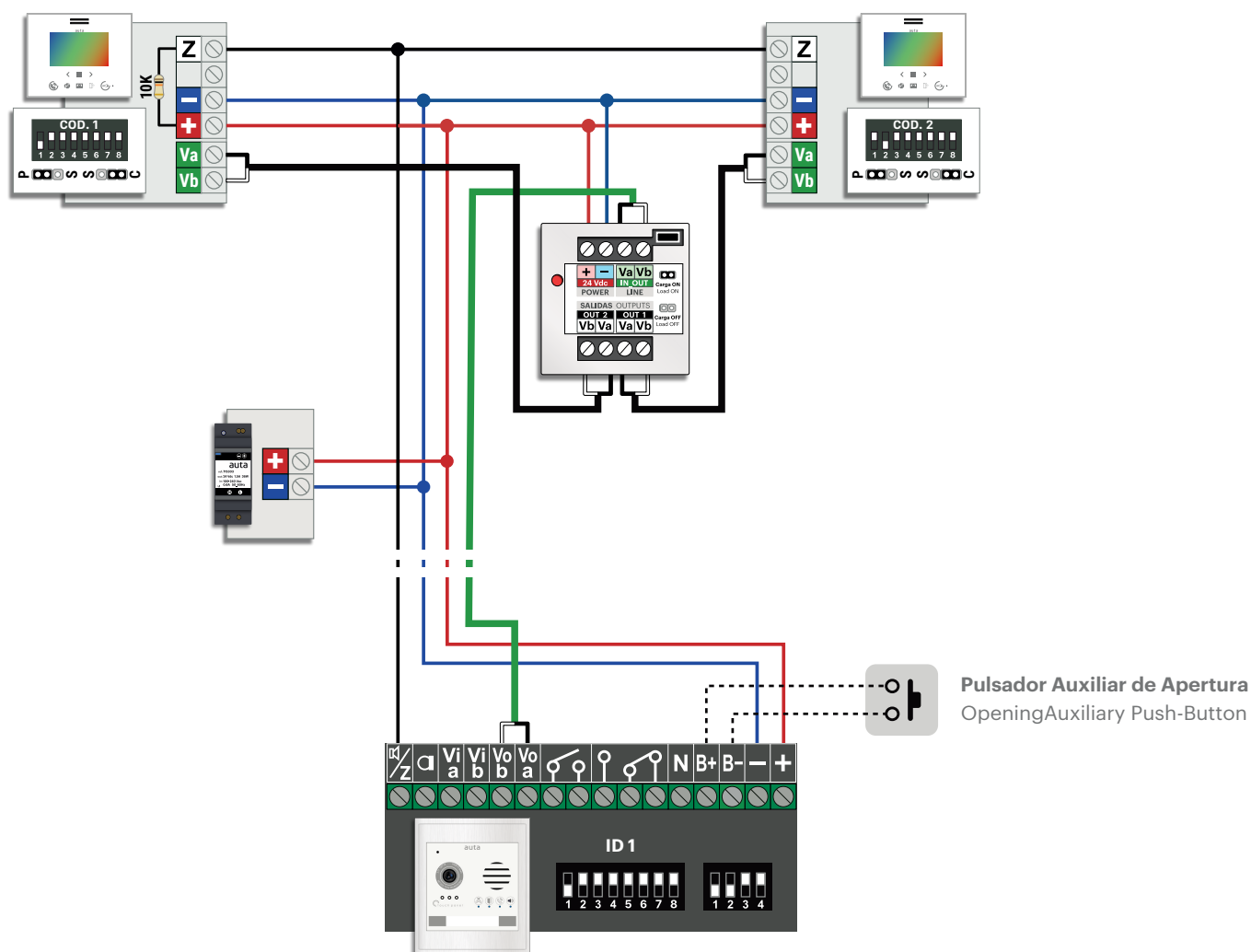

# Configuración Configuration

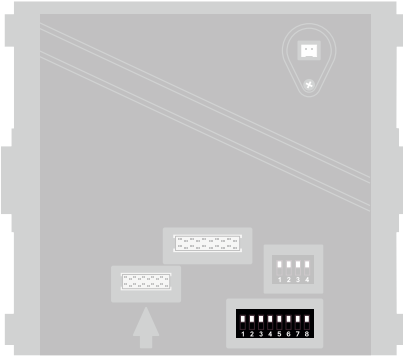

## Configuración de ID de placa Panel ID configuration

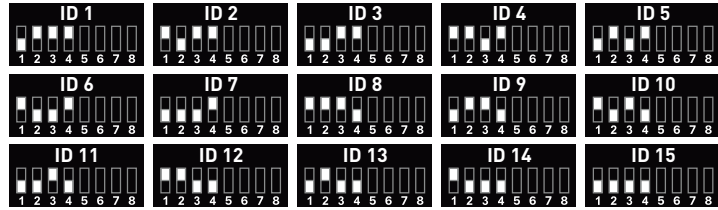

## AUTO-ENCENDIDO a placa SELF-STARTING to panel



## Llamada a CONSERJERÍA Call to CONCIERGE



## Relé 2 Relay 2



## Mensaje "PUERTA ABIERTA" "DOOR OPEN" message

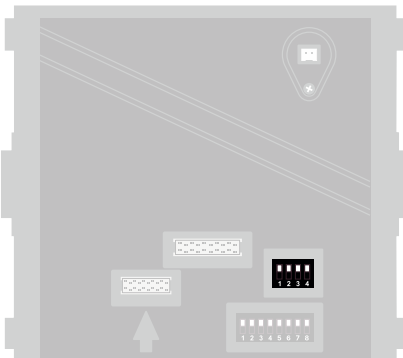

## Selección PRINCIPAL \_ SECUNDARIO MASTER \_ SLAVE selection



**!** Sistema VISUALTECH SIEMPRE OFF  
VISUALTECH system ALWAYS OFF









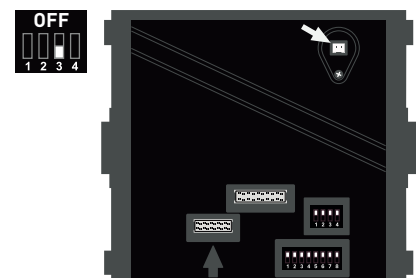
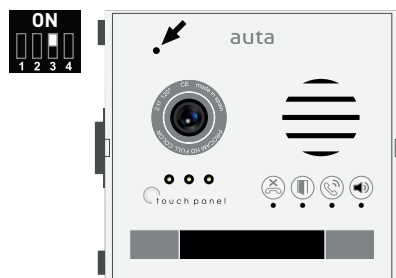





































## Selección de LLAMADA CALL selection



## Selección de MICRÓFONO MICROPHONE selection



## Funciones especiales Special functions

PASOS STEPS	FUNCIÓN FUNCTION	BINARIO BINARY
1º	Alimentar el módulo Supply the module	
2º	Anotar configuración del módulo Write down module settings	
3º	Entrar en modo programación Enter in programming mode  LEDS ON	 LEDS ON
4º	Configurar el código o códigos de función (tabla) Set the desired function code or codes (table)	
1	<b>Re-assignar código de llamada pulsador IZQUIERDA (defecto código 1)</b> Re-assign calling code to LEFT PUSH-BUTTON (default code 1)	 →  →  →  →  → 
2	<b>Re-assignar código de llamada pulsador DERECHA</b> Re-assign calling code to RIGHT PUSH-BUTTON	 →  →  →  →  → 
3	<b>Re-assignar tiempo de apertura 1, vivienda (defecto 2 segundos)</b> Re-assign opening time 1, flat (default 2 seconds)	 →  →  →  →  → 
4	<b>Re-assignar tiempo de apertura 2, pulsador externo y código (defecto 5 segundos)</b> Re-assign opening time 2, external button and code (default 5 seconds)	 →  →  →  →  → 
6	<b>Placa configurada como EXTERIOR (bus X SDL) (habilitar llamada a conserjería)</b> Panel configured as EXTERNAL (X SDL bus) (activate concierge call)	 →  → 
7	<b>Código de SDL al que llamará P1 (el cod. de vivienda será el asignado en la func. 1)</b> SDL code where P1 will call (House code will be the one assigned in function 1)	 →  →  →  →  → 
8	<b>Código de SDL al que llamará P2 (el cod. de vivienda será el asignado en la func. 2)</b> SDL code where P2 will call (House code will be the one assigned in function 2)	 →  →  →  →  → 
9	<b>Placa configurada como INTERIOR (anula función 6)</b> Panel configured as INTERNAL (disable func. 6)	 →  → 



## Funciones especiales Special functions

129	<b>Mensaje "Puerta abierta" en ESPAÑOL</b> "Door open" message in SPANISH	
130	<b>Mensaje "Puerta abierta" en CATALÁN</b> "Door open" message in CATALAN	
131	<b>Mensaje "Puerta abierta" en INGLÉS</b> "Door open" message in ENGLISH	
132	<b>Mensaje "Puerta abierta" en PORTUGUÉS</b> "Door open" message in PORTUGUESE	
133	<b>Mensaje "Puerta abierta" en FRANCÉS</b> "Door open" message in FRENCH	
255	<b>Valores de fábrica</b> Factory settings	

5°

Salir del modo programación



Exit of programming mode



6°

Restablecer configuración del módulo (paso 2°)

Restore the module configuration (step 2°)

## Ajuste de volumen Volume adjust

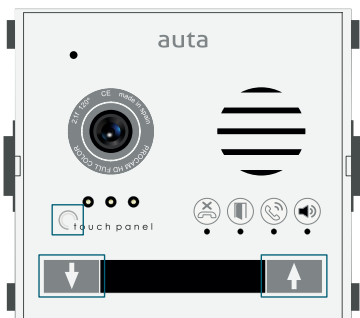

### Entrar en modo ajuste de volumen Enter in volume adjust mode

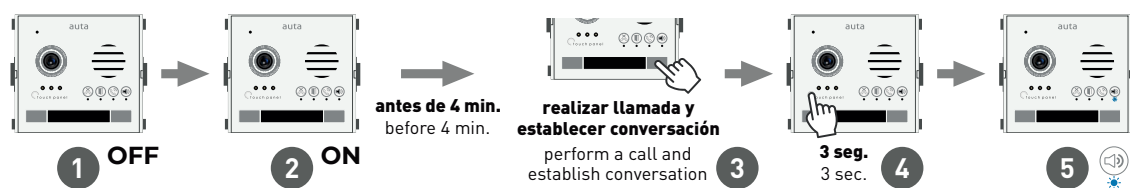

Existen 3 parámetros en los que podemos realizar ajustes de volumen:

1. Volumen de AUDIO en PLACA
2. Volumen de AUDIO en VIVIENDA
3. Volumen de AUDIO en mensaje "PUERTA ABIERTA"

Disponemos de 8 niveles de audio seleccionables, representados por 4 LEDS azules. Cada led indica 2 niveles.

There are 3 parameters in which we can make volume adjustments:

1. AUDIO volume at PANEL
2. AUDIO volume at HOUSING
3. AUDIO volume for "DOOR OPEN" message

We have 8 selectable audio levels, represented by 4 blue LEDs. Each led indicates 2 levels.

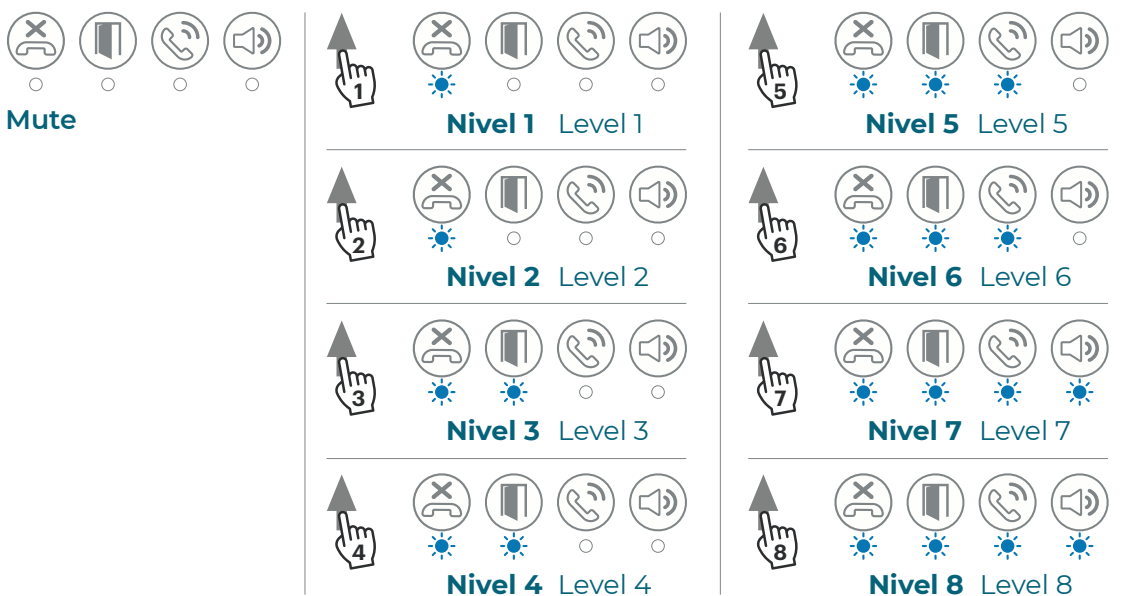

## Modo mantenimiento Maintenance mode

El modo mantenimiento es un modo en el que la placa desactiva todos sus módulos conectados por seguridad, así se pueden realizar procedimientos tales como limpieza o la colocación de información en los tarjeteros de los pulsadores, con total seguridad.

El tiempo máximo en el que la placa permanece en modo mantenimiento es de 4 minutos. Pasado este tiempo se deberá re-armar.

The maintenance mode is a mode in which the panel deactivates all its connected modules for safety reasons, so procedures such as cleaning or placing information in the button card holders, can be carried out in complete safety.

The maximum time that the panel remains in maintenance mode is 4 minutes. After this time, it must be re-armed.

### Entrar en modo mantenimiento Enter in maintenance mode

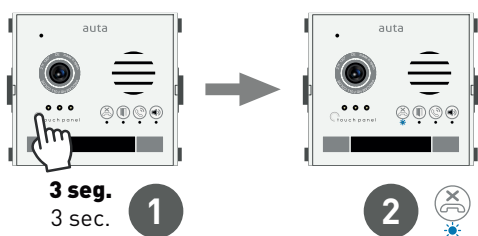



## Ajuste de balance Balance adjust

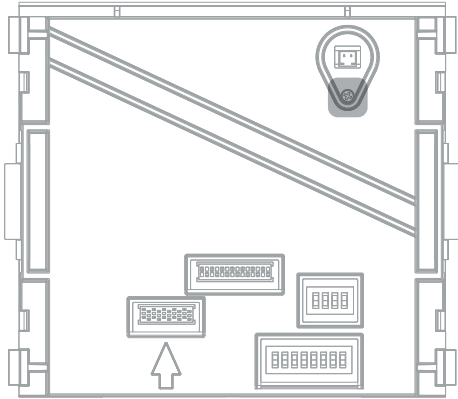

### Ajuste de balance de audio.

Girar ligeramente hacia la derecha o izquierda hasta que el sonido de acoplamiento desaparezca.

Cada vez que se ajusta el volumen de audio hacia vivienda o hacia placa, se deberá re-ajustar de nuevo el balance general.

### Audio balance adjustment.

Rotate slightly to the right or left until the coupling sound disappears.

Each time the audio volume towards the home or the panel is adjusted, the general balance must be re-adjusted again.

## Montaje Mounting

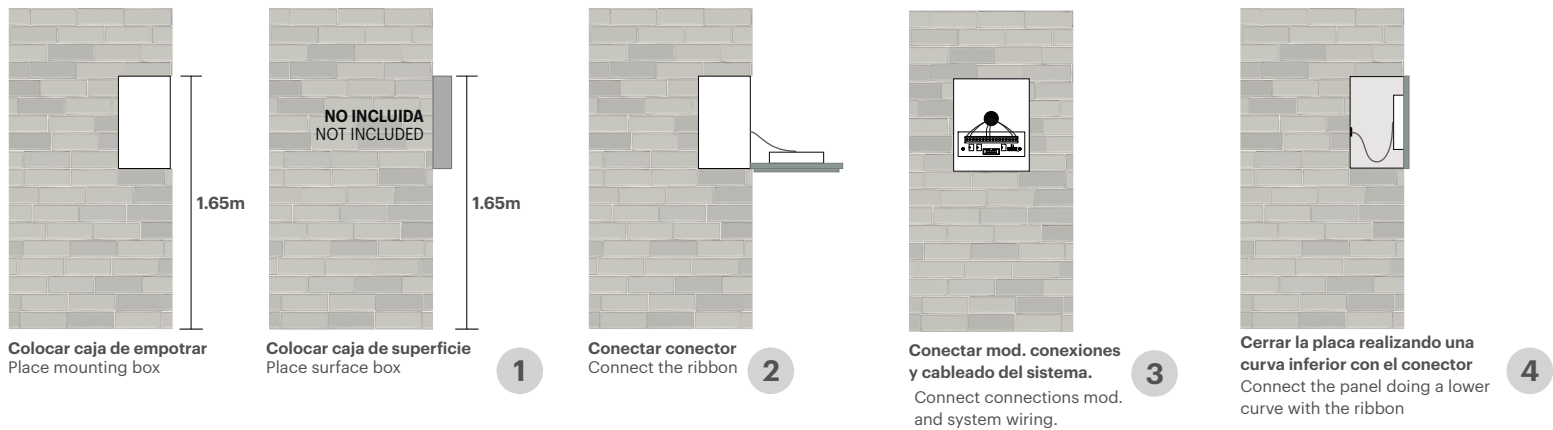



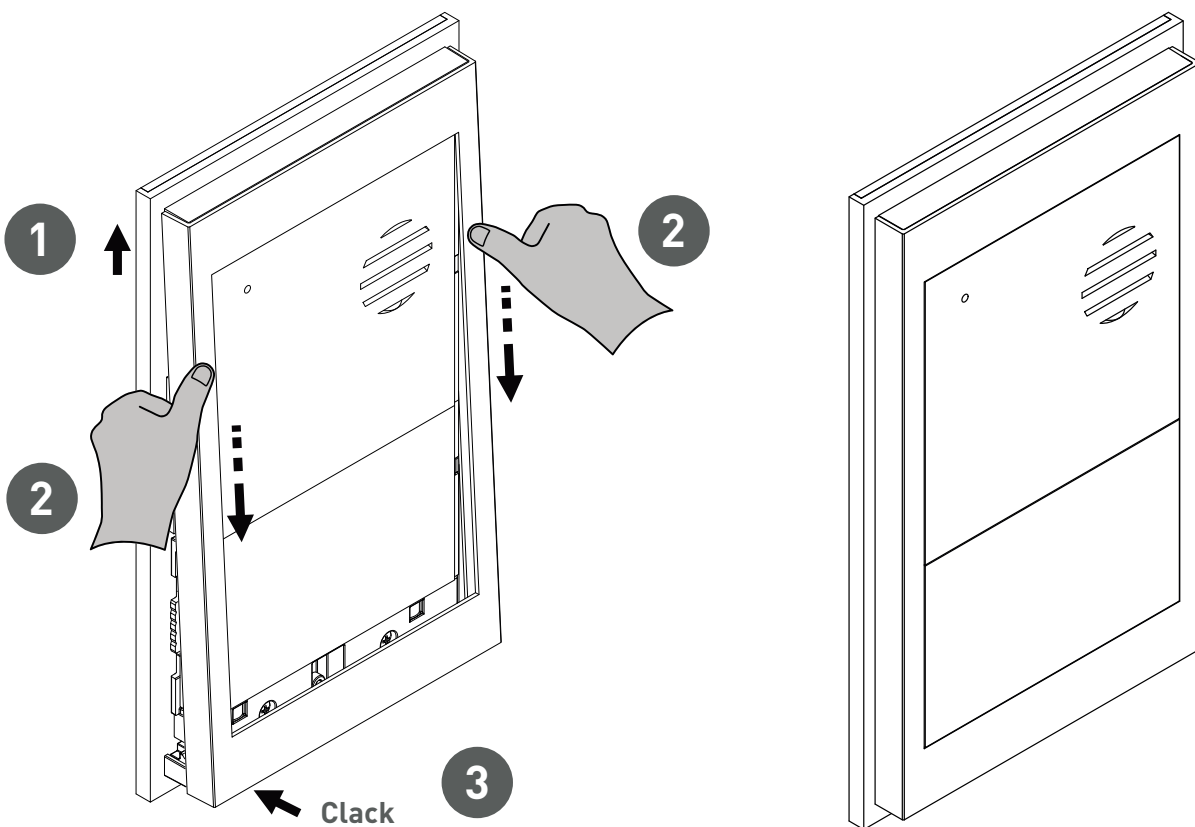

## Montaje del perfil Profile assembly



**Nº MÁXIMO DE ELEMENTOS** MAX. NUMBER OF ELEMENTS

ELEMENTOS UNITS	ALV-1.5A (715303)	ALV-2.5A (715703)
 LLAMADA SIMULTANEA SIMULTANEOUS CALL	<b>3</b>	<b>5</b>

**SECCIONES Y CONEXIONES RECOMENDADAS** RECOMMENDED SECTIONS AND CONNECTIONS

	CAT 5/6/FTP	AUTA
par NARANJA ORANGE pair		<b>+</b>
par VERDE GREEN pair		<b>-</b>
cable AZUL_BLANCO BLUE_WHITE wire		<b>Va</b>
cable AZUL BLUE wire		<b>Vb</b>
par MARRÓN BROWN pair		<b>Z</b>
	<b>100% COBRE</b> 100% COPPER	

SECCIONES WIRING SECTIONS	HASTA 100m UP TO 100m
<b>+ - Z Va Vb</b>	<b>0.22mm AWG22</b>
EL CABLEADO NO DEBE PASAR CERCA DE LA LINEA ELÉCTRICA WIRING MUST NOT BE RUN CLOSE TO THE ELECTRICAL LINE	

NO DUPLICAR CABLES Va Vb  
DON'T DUPLICATE WIRES Va Vb



Vb  
Va



Vb  
Va

**GESTIÓN DE ABREPUERTAS** DOOR OPENER MANAGEMENT

