

neos

DIGITAL



ES KVD- 3_12 NO-COAX

EN KVD- 3_12 COAXLESS

auta

Bringing people together

Elementos en el kit Elements in the kit



Características Features

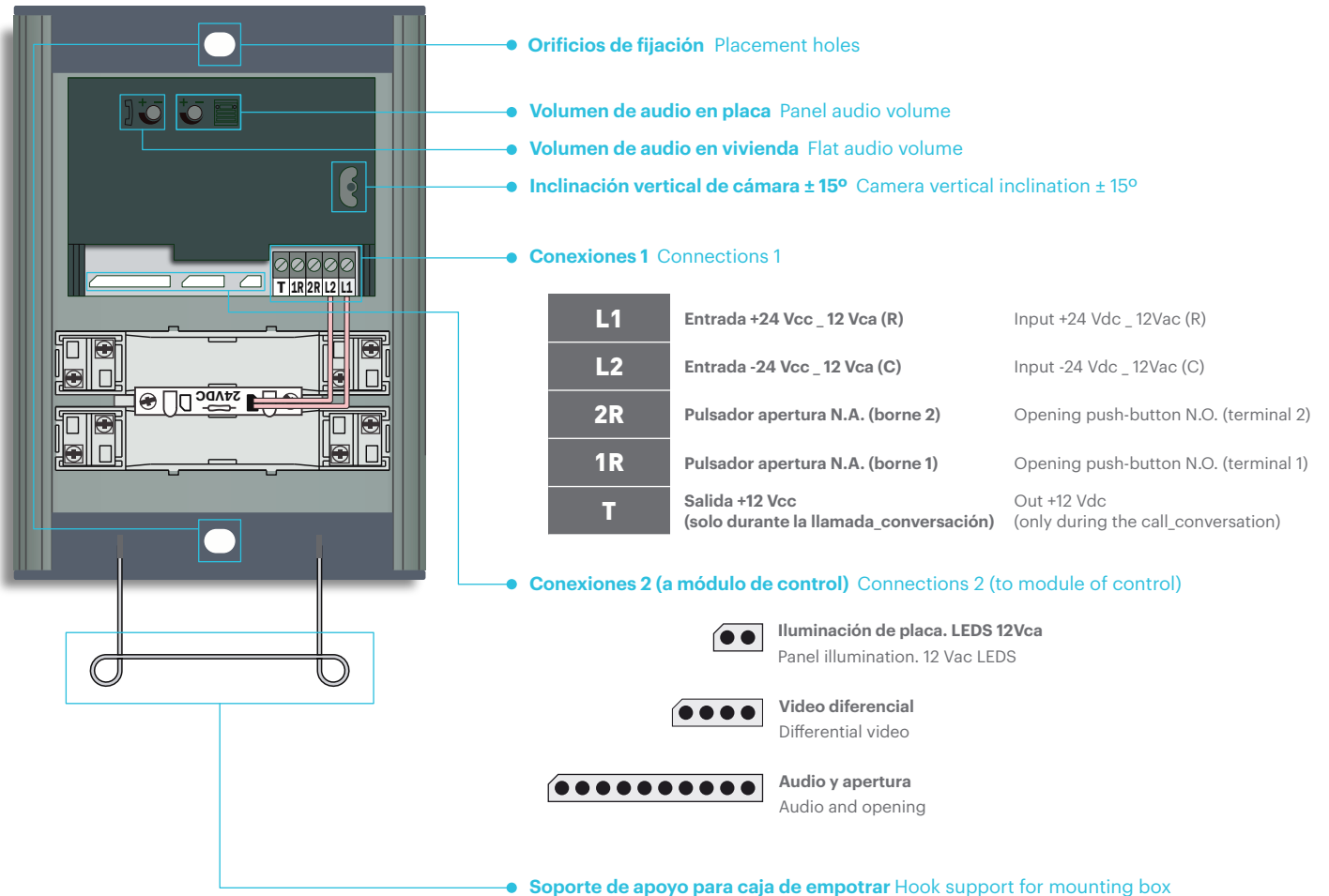
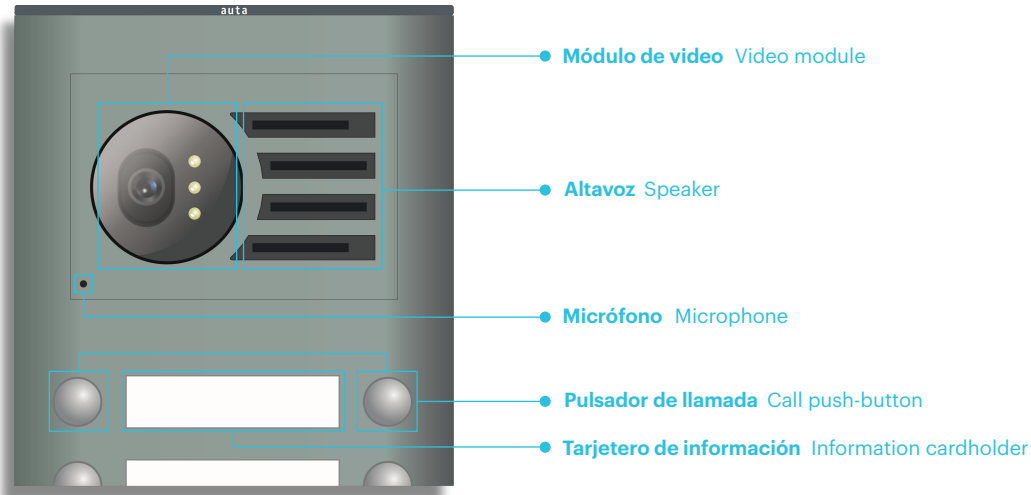

Montaje Mounting

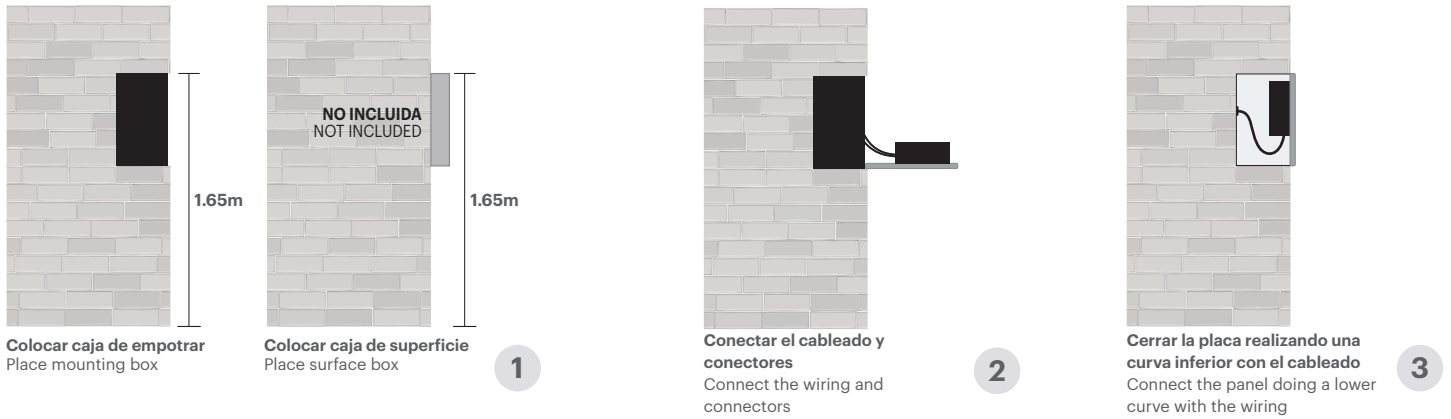

Colocar información en el tarjetero Place information in the cardholder

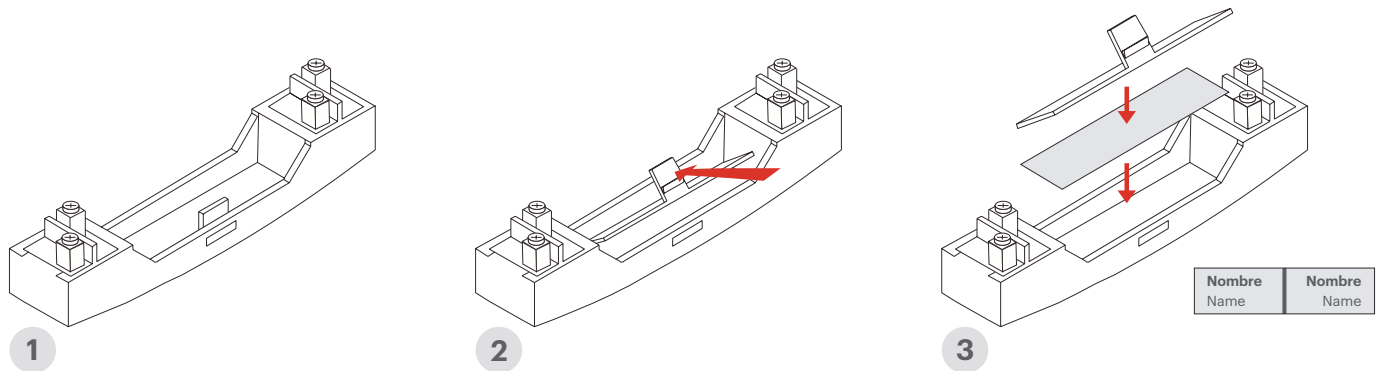

Conexión Connection

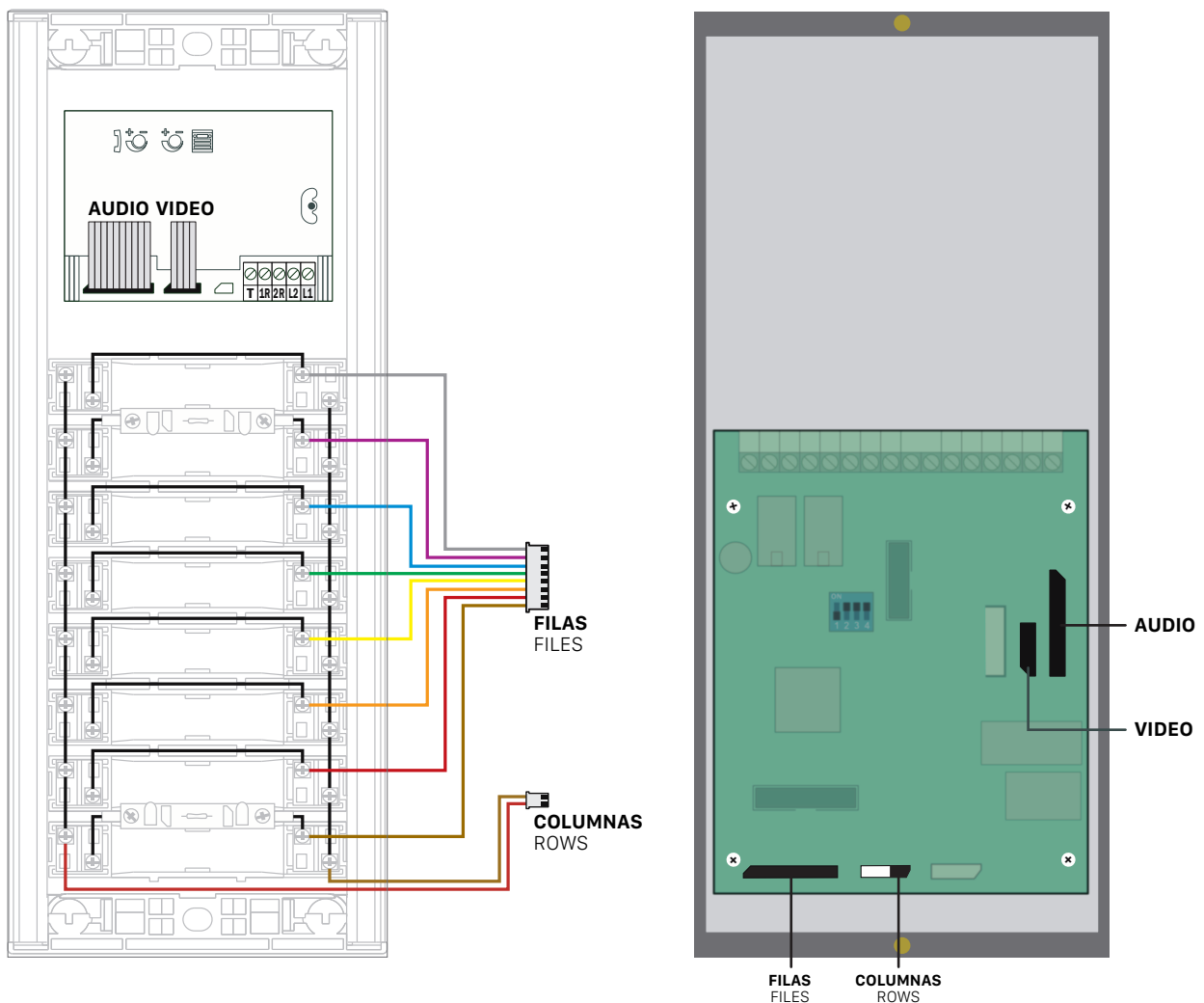

Instalación Installation

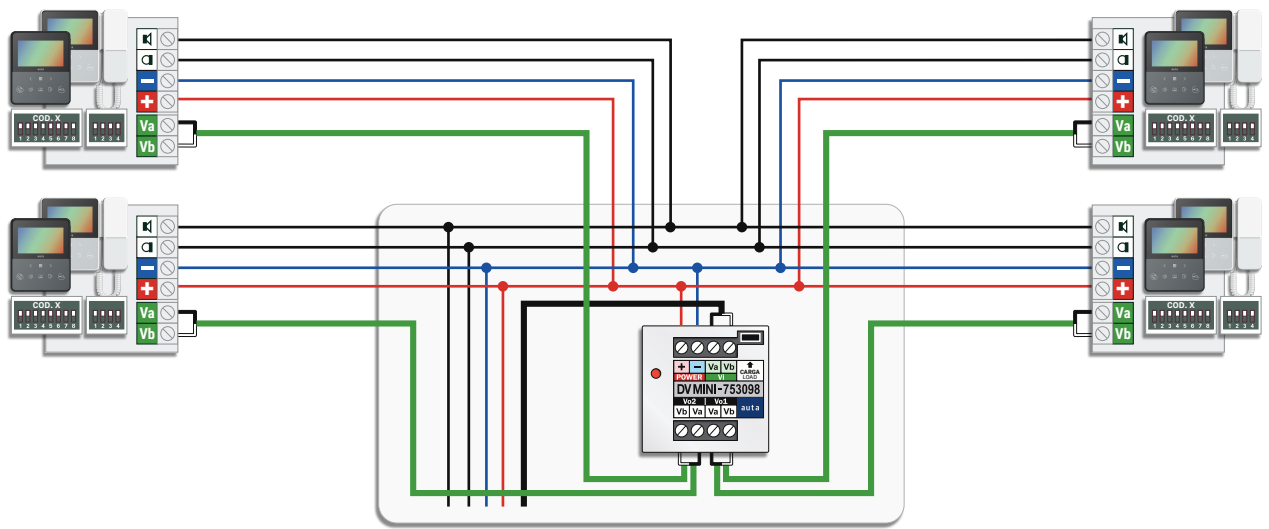

ULTIMA PLANTA
LAST FLOOR

PLANTAS INTERMEDIAS
INTERMEDIATE FLOORS

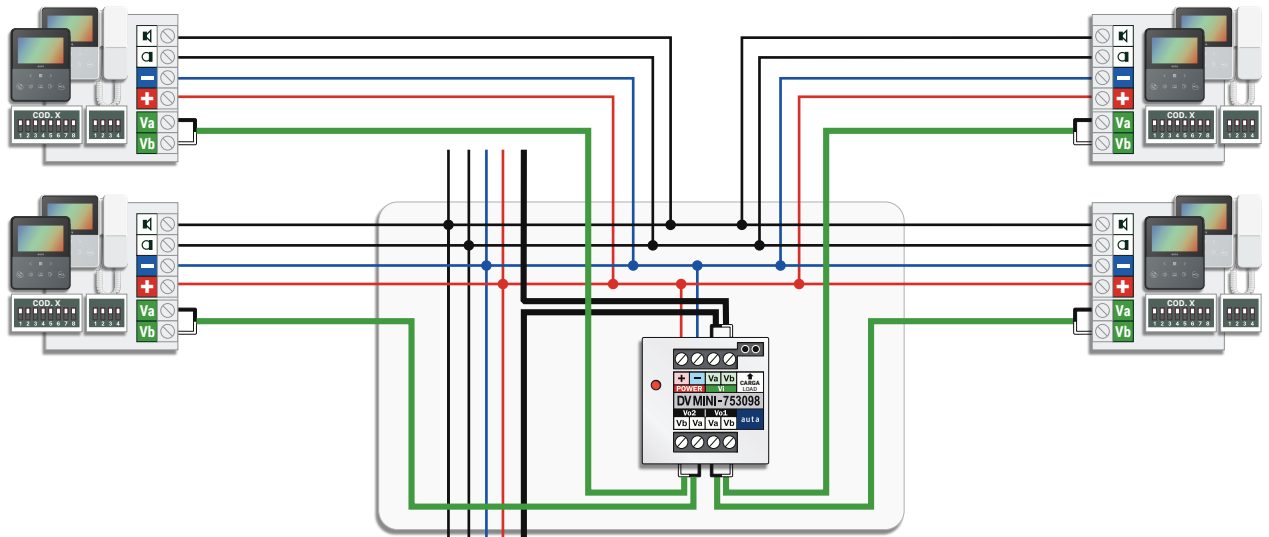

PLANTA 1
FLOOR 1



Apertura
Opening

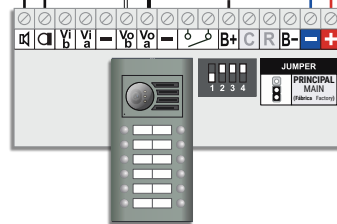

Manual de instalación VIDEO NO-COAX
Installation manual VIDEO COAXLESS

Codificación de monitores Monitors codification

CÓDIGO QUE GENERA CADA PULSADOR CODE THAT GENERATES EVERY PUSH-BUTTON

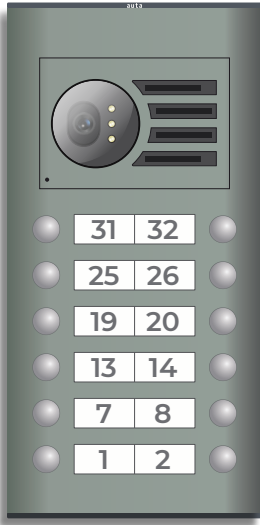

Seleccionar solo los pulsadores que posea nuestra placa.
Select only the push-buttons our panel has.

EJEMPLO 1
EXAMPLE 1



EJEMPLO 2
EXAMPLE 2





CONVERSIÓN DE CÓDIGOS A BINARIO CONVERSION OF CODES TO BINARY

COD. 31 1 2 3 4 5 6 7 8	COD. 32 1 2 3 4 5 6 7 8
COD. 25 1 2 3 4 5 6 7 8	COD. 26 1 2 3 4 5 6 7 8
COD. 19 1 2 3 4 5 6 7 8	COD. 20 1 2 3 4 5 6 7 8
COD. 13 1 2 3 4 5 6 7 8	COD. 14 1 2 3 4 5 6 7 8
COD. 7 1 2 3 4 5 6 7 8	COD. 8 1 2 3 4 5 6 7 8
COD. 1 1 2 3 4 5 6 7 8	COD. 2 1 2 3 4 5 6 7 8

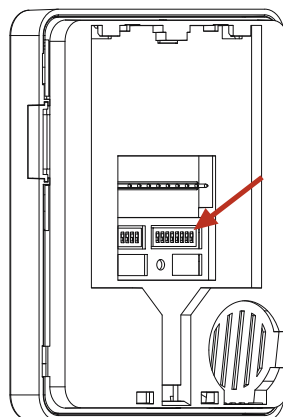
CODIFICACIÓN DE LOS MONITORES CODIFICATION OF MONITORS



ELEMENTOS UNITS	ALV-1.5A (715303)	ALV-2.5A (715703)
	20 ----- 50	40 ----- 100
 LLAMADA SIMULTANEA SIMULTANEOUS CALL	3	5

CONFIGURACIÓN DE VIDEO VIDEO CONFIGURATION



QUITAR EL JUMPER DE CARGA EN TODOS LOS DISTRIBUIDORES DE LA MISMA LINEA EXCEPTO EN EL ÚLTIMO.



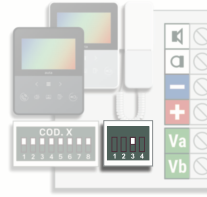





REMOVE THE LOAD JUMPER IN ALL VIDEO DISTRIBUTORS OF THE SAME LINE EXCEPT IN THE LAST ONE.



EN SISTEMAS CON DISTRIBUCION EN CASCADA COLOCAR EL SWITCH 3 ABAJO (OFF) EN TODOS LOS MONITORES DE LA MISMA LINEA EXCEPTO EN EL ÚLTIMO.

AT SYSTEMS WITH SERIAL DISTRIBUTION SET THE SWITCH 3 DOWN (OFF) IN ALL MONITORS OF THE SAME LINE EXCEPT IN THE LAST ONE.

SECCIONES Y CONEXIONES RECOMENDADAS RECOMMENDED SECTIONS AND CONNECTIONS

	CAT 5/6/FTP	AUTA
par NARANJA ORANGE pair		+
par VERDE GREEN pair		-
cable AZUL_BLANCO BLUE_WHITE wire		Va
cable AZUL BLUE wire		Vb
cable MARRÓN_BLANCO BROWN_WHITE wire		
cable MARRÓN BROWN wire		
	100% COBRE	100% COPPER

SECCIONES WIRING SECTIONS	HASTA 100m UP TO 100m	HASTA 200m UP TO 200m
+ -	1mm AWG17	1.5mm AWG15
 	0.5mm AWG20	1mm AWG17
Va Vb	2 x 0.22mm AWG22	
EL CABLEADO NO DEBE PASAR CERCA DE LA LINEA ELÉCTRICA WIRING MUST NOT BE RUN CLOSE TO THE ELECTRICAL LINE		

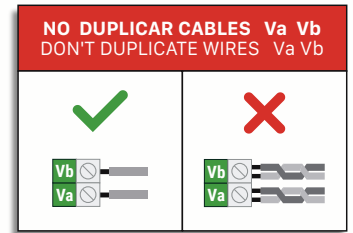

GESTIÓN DE ABREPUERTAS DOOR OPENER MANAGEMENT

