

neos

DIGITAL



REF: 751924

REF: 751934

ES VISUALTECH 5H

EN VISUALTECH 5W

auta

Bringing people together

Descripción Description

Monitor digital VISUALTECH 5H. Permite ser instalado, mediante 5 cables, en cualquier sistema Auta Visualtech. Incorpora una pantalla panorámica LCD COLOR 7", tecnología táctil, audio manos libres, salidas auxiliares multi-función, selección de melodías, funciones especiales.

VISUALTECH 5H digital monitor. It can be installed, using 5 wires, on any Auta Visualtech system. It incorporates a widescreen LCD COLOUR 7", touch technology, hands-free audio, auxiliary multi-function outputs, selection of melodies, special functions.

Características Features

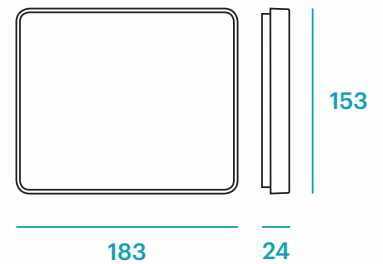
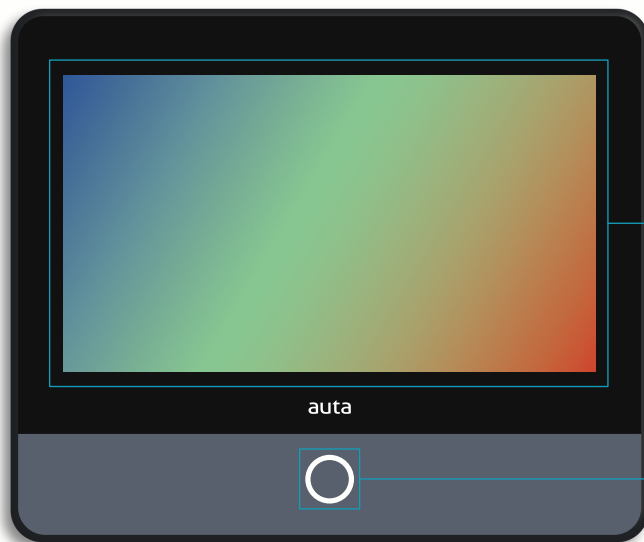

- **Pantalla LCD táctil** Touch LCD screen
- **Pulsador táctil multi-función**
Activación de la pantalla al recibir llamada como SECUNDARIO
Multi-function touch button
Screen activation when receive a call as SLAVE

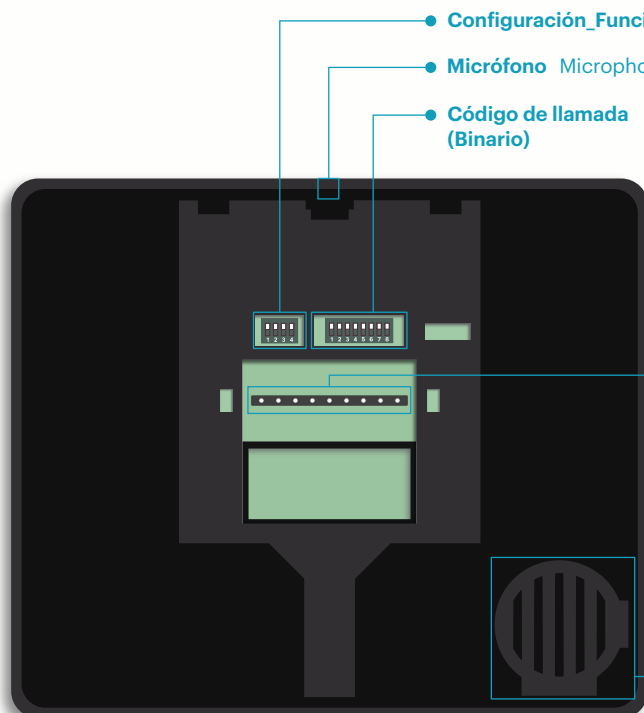

- **Configuración_Funciones especiales** Configuration_Special functions
- **Micrófono** Microphone
- **Código de llamada (Binario)** Call code (Binary)

- **Conexiones** Connections
- **Altavoz** Speaker

Montaje Mounting

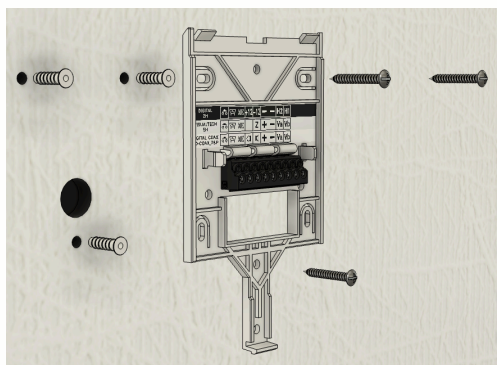

Soporte NO INCLUIDO
Bracket NOT INCLUDED

1

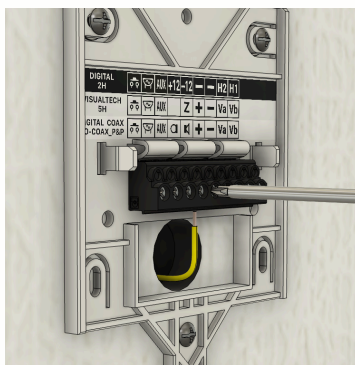

2



2 (click)

3

Instalación Installation

Monitor como principal Monitor as main

Monitor como secundario Monitor as secondary

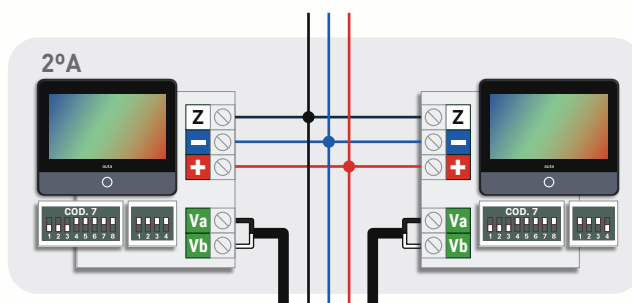
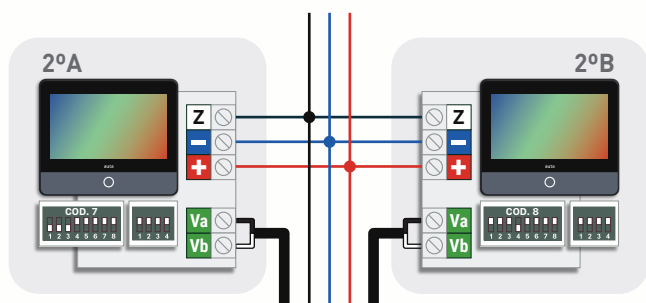

Manual de instalación VIDEO VISUALTECH 5H
Installation manual VIDEO VISUALTECH 5W

Configuración Configuration

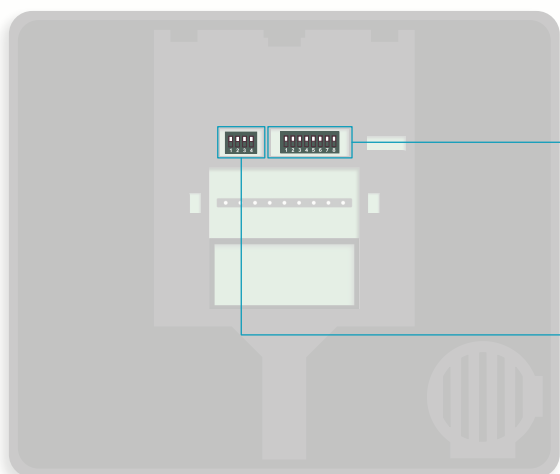

Configuración del sistema digital
Digital system configuration



Principal
Main



Secundario
Secondary



Carga video ON
Video load ON



Carga video OFF
Video load OFF

Pantalla de información Information screen

Dejar presionado . Para salir volver a pulsar o esperar 30 segundos.

Leave pressed . To exit we will press again or wait 30 seconds.

WEB NEOS NEOS WEB



5 V 1.0
1 9 1 1 1 3
0 0 1 0 4
4 0 0 0

Tecnología, 2 (2 Hilos) 5 (Visualtech 5H) 6 (Digital) -- Versión Technology, 2 (2 Wires) 5 (Visualtech 5W) 6 (Digital) -- Version
Versión de la compilación Build version
ID binario_Verde (Principal) Rojo (Secundario) -- Última ID placa Binary ID_Green (Main) Red (Secondary) -- Last panel ID
Nº de tonos de llamada -- Funciones especiales programadas No. of call tones -- Special functions programmed

Funcionamiento

ES

activación del monitor

EN REPOSO, para prevenir pulsaciones indeseadas, el monitor incorpora un sistema de seguridad en el que la pantalla táctil permanece bloqueada hasta que se presiona el pulsador .

menú de usuario

Al presionar el pulsador de activación  el monitor nos ofrece 4 opciones.

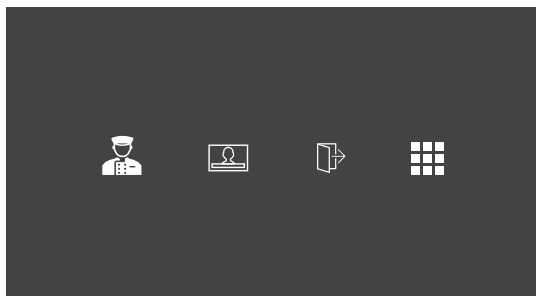

Al presionar podemos realizar una llamada a central de conserjería. Si no existe o no está disponible escucharemos un tono de error.



Al presionar podemos realizar un autoencendido sobre la última Placa_DRP almacenada. Pulsando de nuevo cambiaremos entre Placas_DRP's si existe más de una.



Al presionar accionaremos la salida auxiliar del monitor.



Al presionar accederemos al menú de configuración de melodías y volumen del tono de llamada.

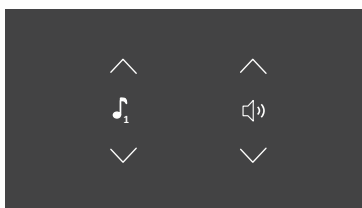

Seleccionaremos los ajustes presionando las flechas arriba y abajo. Pulsando en el icono escucharemos la selección.

El icono  indicará modo "Silencio".

opciones durante la conversación o llamada

Cuando se recibe una llamada o se establece comunicación con una Placa_DRP, las siguientes opciones estarán disponibles.



Al presionar podemos accionar la apertura del elemento que estemos viendo en pantalla.



Al presionar podemos cambiar entre Placas_DRP's si existe más de uno. Si solo existe una Placa al presionar el monitor pasará a reposo.



Al presionar abriremos el canal de comunicación.



Al presionar finalizaremos la conversación en curso y el monitor pasará a reposo.



Al presionar accionaremos la salida auxiliar del monitor.



Al presionar accederemos al menú de ajuste de imagen, brillo, color y contraste. Cada pulsación nos mostrará un ajuste diferente. Deslizando la barra o presionando en un punto determinado de la misma cambiará los valores.

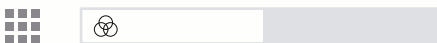

Pulsar para cambiar de menú

Functioning



monitor activation

AT STANDBY, to prevent unwanted keystrokes, the monitor incorporates a security system in which the touch screen remains locked until the button is pressed.

user menu

By pressing the activation button , the monitor offers us 4 options.

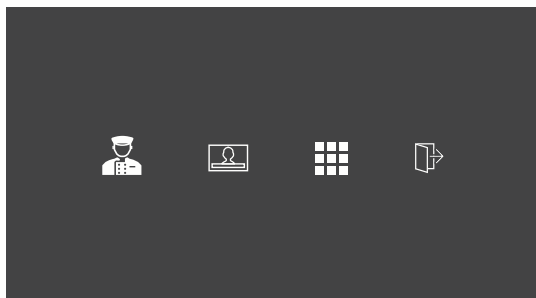

Press to make a call to the concierge unit. If it does not exist or is not available we will hear an error tone.



Press to perform a self-starting on the last stored DRP_Panel. Pressing again we will change between Panels_DRP's if there is more than one.



Press to activate the auxiliary output of the monitor.



Press to access the melodies and ringtone volume settings menu.

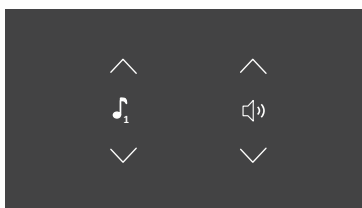

We will select the settings by pressing the up and down arrows. By pressing on the icon we will hear the selection.

The icon will indicate "Silent" mode.

options during conversation or call

When a call is received or communication is established with a Panel_DRP, the following options will be available.



Press to activate the opening of the element that we are seeing on the screen.



Press to switch between Panels_DRP's if there is more than one. If there is only one Panel by pressing, the monitor will go to standby.



Press to open the communication channel.



Press to end the conversation in progress and the monitor will go to sleep.



Press to activate the auxiliary output of the monitor.



Press to access the image brightness, colour and contrast adjustment menu. Each press will show us a different setting. Sliding the bar or pressing at a certain point on it will change the values.



Press to change the menu

Funciones especiales Special functions

Programación de funciones especiales Programming of special functions

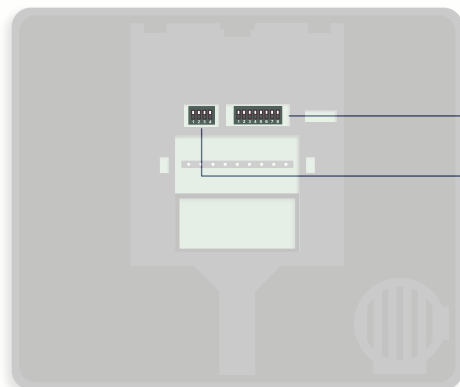

1°	Alimentar el monitor	Supply the monitor
2°	Anotar configuración del monitor	Write down monitor settings
3°	Entrar en modo programación. Led ON	Enter in programming mode. Led ON
4°	Configurar el código de función (tabla)	Set the desired function code (template)
5°	Validar código	Validate the code
6°	Salir del modo programación. Led OFF	Exit of programming mode. Led OFF
7°	Restablecer configuración del monitor	Restore the monitor configuration

Tabla de funciones especiales Special functions table

FUNCIÓN FUNCTION		BINARIO BINARY			
1, 2, 3, 4	Nº de tonos de llamada Nº of calling tones				
		1 tono 1 tone	2 tonos 2 tones	3 tonos 3 tones	4 tonos 4 tones
5	Modo silencio, la salida se activa tantas veces como el Nº de tonos Silent mode, the output is activated as many times as the Nº of tones				
6	La salida se activa durante 30 segundos al recibir una llamada The output is activated during 30 seconds when a call is received				
7	Salida AUX configurada en modo pulso (1 seg.), fábrica, o modo conmutador (ON_OFF) AUX output set as pulse mode (1 sec.), factory, or in toggle mode (ON_OFF)				
9	La entrada pasa a ser entrada remota de apertura de puerta. Input becomes in remote door release input.				
13	Monitor configurado como secundario muestra imagen automáticamente durante la llamada. Monitor configured as secondary shows image automatically during the call.				
255	Valores de fábrica Factory settings				