

neos

DIGITAL



REF: 751810



REF: 751820

ES VISUALTECH 5H

EN VISUALTECH 5W

auta

Bringing people together

Descripción Description

Monitor digital VISUALTECH 5H. Permite ser instalado, mediante 5 cables, en cualquier sistema Auta Visualtech. Incorpora una pantalla panorámica LCD COLOR 4.3", tecnología táctil, audio DUAL (manos libres y auricular), salidas auxiliares multi-función, selección de melodías, funciones especiales.

VISUALTECH 5H digital monitor. It can be installed, using 5 cables, on any Auta Visualtech system. It incorporates a widescreen LCD COLOUR 4.3 ", touch technology, DUAL audio (hands-free and handset), auxiliary multi-function outputs, selection of melodies, special functions.

Características Features

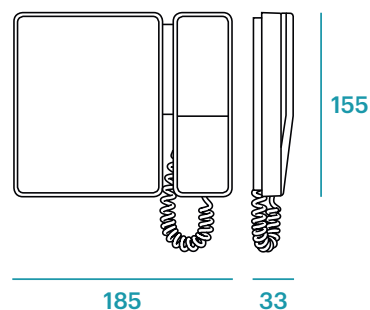
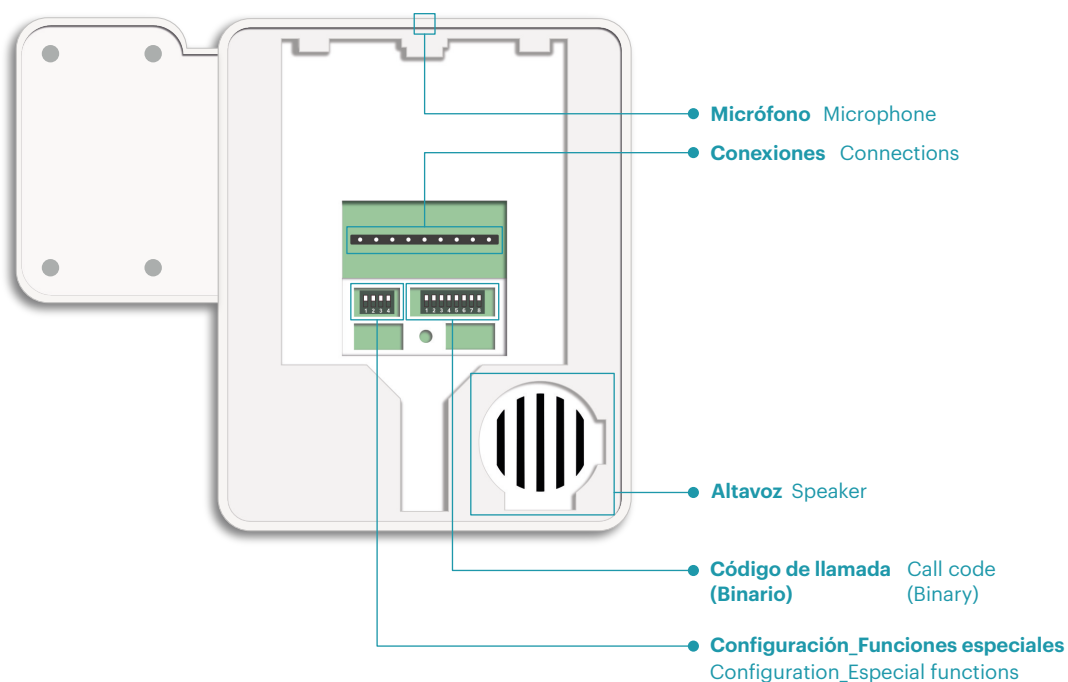
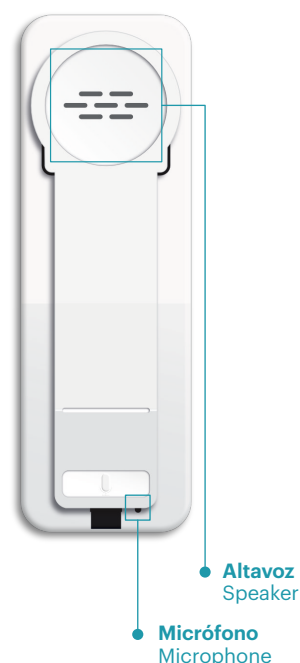

Montaje Mounting

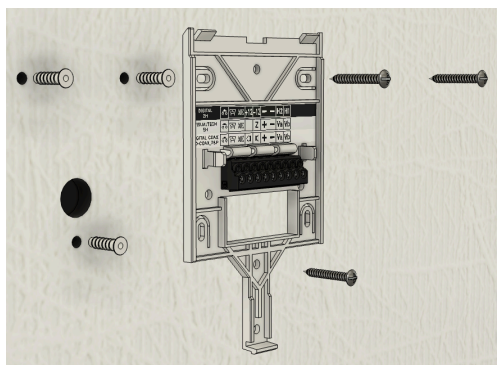

1 Soporte NO INCLUIDO
Bracket NOT INCLUDED

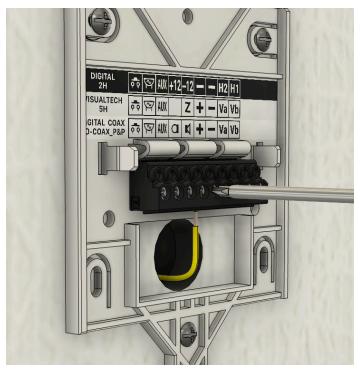

2



3

Instalación Installation

Monitor como principal Monitor as main

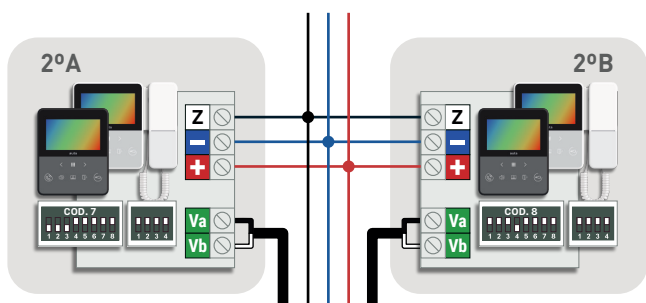

Monitor como secundario Monitor as secondary

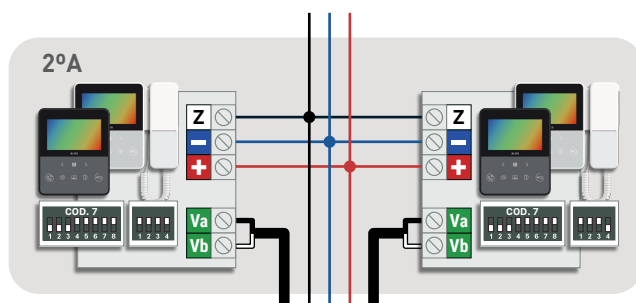

Manual de instalación VIDEO VISUALTECH 5H
Installation manual VIDEO VISUALTECH 5W

Configuración Configuration

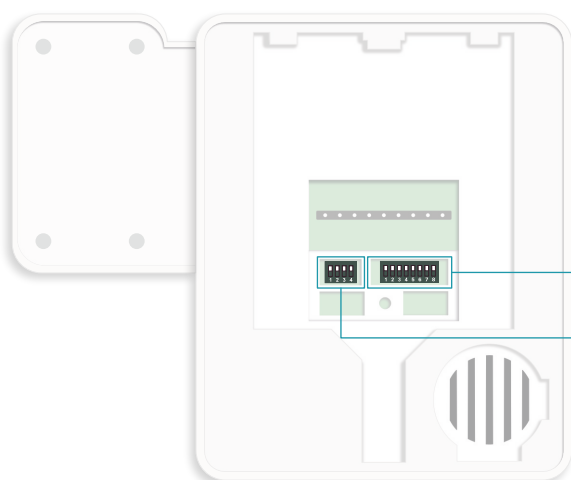

Configuración del sistema digital
Digital system configuration



Principal
Main



Secundario
Secondary



Carga video ON
Video load ON



Carga video OFF
Video load OFF

Pantalla de información Information screen

Pulsar para activar el teclado, seguidamente dejar presionado . Para salir volver a pulsar o esperar 30 segundos.

Press to activate the keypad, then leave pressed . To exit we will press again or wait 30 seconds.

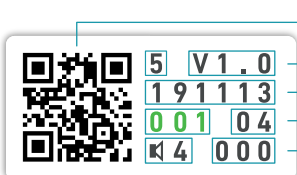

WEB NEOS NEOS WEB

5 V1.0 Tecnología, 2 (2 Hilos) 5 (Visualtech 5H) 6 (Digital) -- Versión Technology, 2 (2 Wires) 5 (Visualtech 5W) 6 (Digital) -- Version
1 9 1 1 1 3 Versión de la compilación Build version
0 0 1 0 4 ID binario_Verde (Principal) Rojo (Secundario) -- Última ID placa Binary ID_Green (Main) Red (Secondary) -- Last panel ID
4 0 0 0 N° de tonos de llamada -- Funciones especiales programadas No. of call tones -- Special functions programmed





Funcionamiento_ES

activación del teclado en reposo

EN REPOSO, para prevenir pulsaciones indeseadas, el monitor incorpora un sistema de seguridad en el que el teclado táctil permanece bloqueado hasta que se presiona el pulsador 

llamada y conversación

Cuando se recibe una llamada desde placa de calle el monitor comienza a sonar durante un tiempo máximo de 30 segundos. De forma estándar efectúa 4 timbrados con intervalos de 4 segundos entre cada uno de ellos.

Durante el periodo de llamada la imagen aparece en la pantalla, el usuario podrá abrir directamente, presionando el pulsador , o establecer una conversación, en modo manos libres, presionando , o en modo privado simplemente descolgando el auricular . La conversación tiene un máximo de 90 segundos. Si se desea continuar con la conversación se deberá activar el teclado y presionar el pulsador 

función audio dual



En todo momento el usuario puede alternar entre el modo "manos libres" y el modo "privado", indefinidamente, durante el tiempo que dure la conversación.

Si el monitor se encuentra en modo "manos libres", tan solo se deberá descolgar el auricular  y el sistema pasará a modo "privado" de forma automática.

Si el monitor se encuentra en modo "privado", tan solo se deberá presionar el pulsador , y el sistema pasará a modo "manos libres". Posteriormente el usuario podrá colgar el auricular sin perder la comunicación.

auto-encendido

Activando el teclado y presionando el pulsador  el usuario podrá establecer comunicación con la PLACA DE CALLE / CÁMARA CCTV que desee en el caso de existir más de una en la instalación.

Con cada pulsación  el sistema conmutará automáticamente al siguiente dispositivo, mostrando imagen y permitiendo la apertura de este presionando el pulsador 

llamada a conserje

Si estando el monitor en reposo se activa el teclado y se presiona el pulsador  se efectuará una llamada a central de conserjería. Si el sistema no cuenta con ninguna central instalada el monitor emitirá un aviso de error.

selección de melodías y volumen de llamada

Estando el monitor en reposo, se activa el teclado y se presiona el pulsador . Con cada pulsación seleccionaremos una melodía y un volumen de llamada diferente.

Existen 4 melodías de llamada y 2 niveles de volumen para cada una (MEDIO - ALTO)

ajuste de imagen

El monitor permite el ajuste de los niveles de brillo, color y contraste. Cuando aparezca la imagen en pantalla, se deberá presionar el pulsador . Cada pulsación alterna entre los 3 ajustes disponibles.

Para ajustar el valor deseado presionar los pulsadores < >





función ding dong

El monitor permite prescindir del timbre interior de la vivienda, integrando así las dos llamadas (placa exterior y vivienda) en un solo dispositivo. Se diferenciarán automáticamente dichas llamadas con melodías y destellos diferentes. Para disponer de esta función tan solo se ha de conectar el pulsador de la vivienda interior al monitor.

función vigilancia cctv

El monitor permite el control de placas y cámaras CCTV automáticamente. Se activa el teclado y se presiona el pulsador . Cada pulsación activará un dispositivo diferente. Para ello se ha de instalar cada cámara CCTV junto a un interface Auta digital.

función privacidad

El monitor incorpora un modo privacidad en el que se silencian los tonos de llamada durante un tiempo determinado. Si el modo privacidad está activo el monitor muestra mediante destellos la franja de tiempo seleccionada (1 destello - **2 horas**, 2 destellos - **4 horas**, 3 destellos - **6 horas**, 4 destellos - **8 horas**). Pasada la franja horaria seleccionada el monitor vuelve automáticamente a funcionamiento estándar. Para activar el modo privacidad activar el teclado y presionar el pulsador  durante 4 segundos ( comenzará a parpadear), seleccionaremos la franja horaria deseada presionando el pulsador . Con cada pulsación se activará una franja horaria distinta entre las 4 disponibles. Validaremos la franja horaria deseada pulsando la tecla 

funciones externas

El monitor dispone de 1 pulsador  que permiten realizar maniobras auxiliares, como el accionamiento de puertas de garaje, encendido de luces, riego, etc...

Para ello se usará un relé auxiliar Auta conectado al circuito de maniobra que se desee controlar.





Functioning_EN

keypad activation at standby

IN STANDBY, to prevent unwanted presses, the monitor incorporates a security system in which the touch keyboard remains locked until the push button  is pressed.

calling and conversation

When a call is received from the entrance panel, the monitor starts ringing for a maximum of 30 seconds. As standard, it performs 4 rings with intervals of 4 seconds between each of them.

During the call period the image appears on the screen, the user can open directly, pressing the button , or establish a conversation, in "handsfree mode", pressing the button , or in "private mode" just picking up the handset . The conversation has a maximum of 90 seconds. If you want to continue with the conversation, activate the keypad and press the button .

dual audio function



At any time the user can alternate between the "hands-free" mode and the "private" mode, indefinitely, during the duration of the conversation.

If the monitor is in "hands-free" mode, you just have to pick up the handset  and the system will go into "private" mode automatically.

If the monitor is in "private" mode, all you have to do is press the button  and the system will go into "hands-free" mode. Afterwards, the user can hang up the headset without losing communication.

self-starting

Activating the keypad and by pressings the button  the user can establish communication with the PANEL / CCTV CAMERA that he wishes in the case of more than one is present in the installation.

With each press  the system will automatically switch to the next device, showing the image and allowing the opening of it by pressing the button .

calling to concierge

If the monitor is in standby, activating the keypad and by pressing the button , a call will be made to the concierge unit. If the system does not have a concierge unit installed, the monitor will emit an error beep.

melody selection and adjust of the calling volume

If the monitor is in standby, activate the keypad and press . With each press will select a different melody and a different calling volume.

There is 4 call melodies and 2 volume levels for each one (MEDIUM and HIGH)

image adjustment

The monitor allows adjustment of brightness, colour and contrast levels. When the image appears on the screen, you must press the button . Each press alternates between the 3 available settings.

To adjust the desired value press the push buttons  





ding dong function

The monitor allows to replace the interior bell of the house, this integrates the two calls (outside panel and house bell) in a single device. These calls will be differentiated with different melodies and flashes automatically. In order to have this function, you only have to connect the button of the house bell to the monitor.

cctv surveillance function

The monitor allows the control of panels and CCTV cameras automatically. We activate the keypad and then press the button . Each press on the button will activate a different device. To do this, each CCTV camera must be installed with an Auta digital interface.

privacy function

The monitor incorporates a privacy mode in which the ringing tones are muted for a selected time. If the privacy mode is active, the monitor shows by flashes the selected period of time (1 flash - **2 hours**, 2 flashes - **4 hours**, 3 flashes - **6 hours**, 4 flashes - **8 hours**). After the selected period of time finished, the monitor automatically returns to standard mode. To enable the privacy mode activate the keypad and press the button  for 4 seconds ( start to blink), select the desired period of time by pressing the button . Each press will activate a different period of time between the 3 available ones. Validate the selection by pressing the button .

external functions

The monitor has 1 push-button  that allow auxiliary functions, such as garage doors, lights, irrigation, etc ... To do this, an Auta auxiliary relay must be connected to the control circuit we want to control.

Funciones especiales Special functions

Programación de funciones especiales Programming of special functions

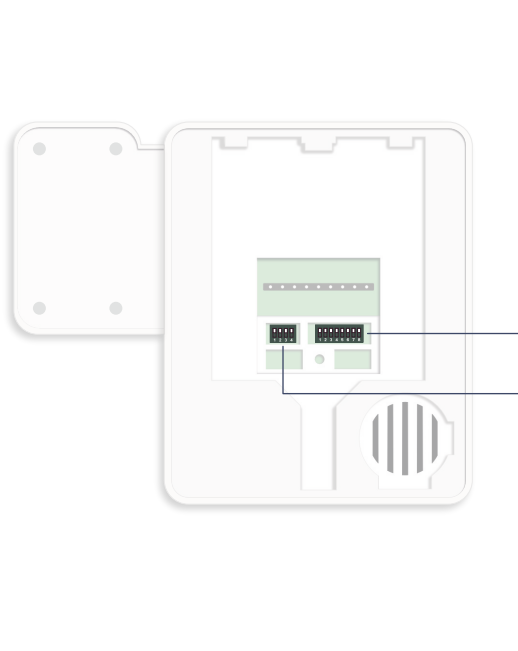

1°	Alimentar el monitor	Supply the monitor
2°	Anotar configuración del monitor	Write down monitor settings
3°	Entrar en modo programación. Led ON	Enter in programming mode. Led ON
4°	Configurar el código de función (tabla)	Set the desired function code (template)
5°	Validar código	Validate the code
6°	Salir del modo programación. Led OFF	Exit of programming mode. Led OFF
7°	Restablecer configuración del monitor	Restore the monitor configuration

Tabla de funciones especiales Special functions table

FUNCIÓN FUNCTION		BINARIO BINARY			
1, 2, 3, 4	Nº de tonos de llamada Nº of calling tones				
5	Modo silencio, la salida se activa tantas veces como el Nº de tonos Silent mode, the output is activated as many times as the Nº of tones				
6	La salida se activa durante 30 segundos al recibir una llamada The output is activated during 30 seconds when a call is received				
7	Salida AUX configurada en modo pulso (1 seg.), fábrica, o modo conmutador (ON_OFF) AUX output set as pulse mode (1 sec.), factory, or in toggle mode (ON_OFF)				
8*	La cerradura de placa se activa de forma automática cuando el monitor recibe una llamada (la función se deberá re-armar cada 4 horas) Electrical lock is activated automatically when the monitor receives a call (the function must be re-enabled every 4 hours)				
9	La entrada pasa a ser entrada remota de apertura de puerta. Input becomes in remote door release input.				
13	Monitor configurado como secundario muestra imagen automáticamente durante la llamada. Monitor configured as secondary shows image automatically during the call.				
14	El pulsador activa el relé 2 de placa Xenia (JULIO 2023 en adelante) The button activates the relay 2 in Xenia panel (JULY 2023 onwards)				
255	Valores de fábrica Factory settings				

* Re-armado: Presionar , presionar 4 segundos. Validar presionando (activado, parpadeo lento)
Re-enable: Press , press for 4 seconds. Validate by pressing (activated, slow blink)