

onex

DIGITAL



REF: 751945

REF: 751955

ES SISTEMA COAX

EN COAX SYSTEM

auta

Bringing people together

Descripción Description

Monitor digital COAX con tecnología Wi-Fi. Puede ser instalado, mediante 4 cables + COAX, en cualquier sistema Auta digital. Incorpora una pantalla panorámica LCD COLOR 7", tecnología táctil, audio manos libres, captura de imágenes durante la llamada, salidas auxiliares multi-función, selección de melodías, funciones especiales. Permite su gestión remota a través de uno o varios dispositivos móviles y nuestra APP **Auta ONEX Wi-Fi**, tanto dentro de la vivienda como en el exterior vía 3G, 4G o 5G.

COAX digital monitor with Wi-Fi technology. It can be installed, using 4 wires + COAX, in any Auta digital system. It incorporates a 7" COLOR LCD panoramic screen, touch technology, hands-free audio, capture images during the call, multi-function auxiliary outputs, melody selection, special functions. It allows remote management through one or several mobile devices and our **Auta ONEX Wi-Fi APP**, both inside the home and outside by 3G, 4G or 5G.

Características Features

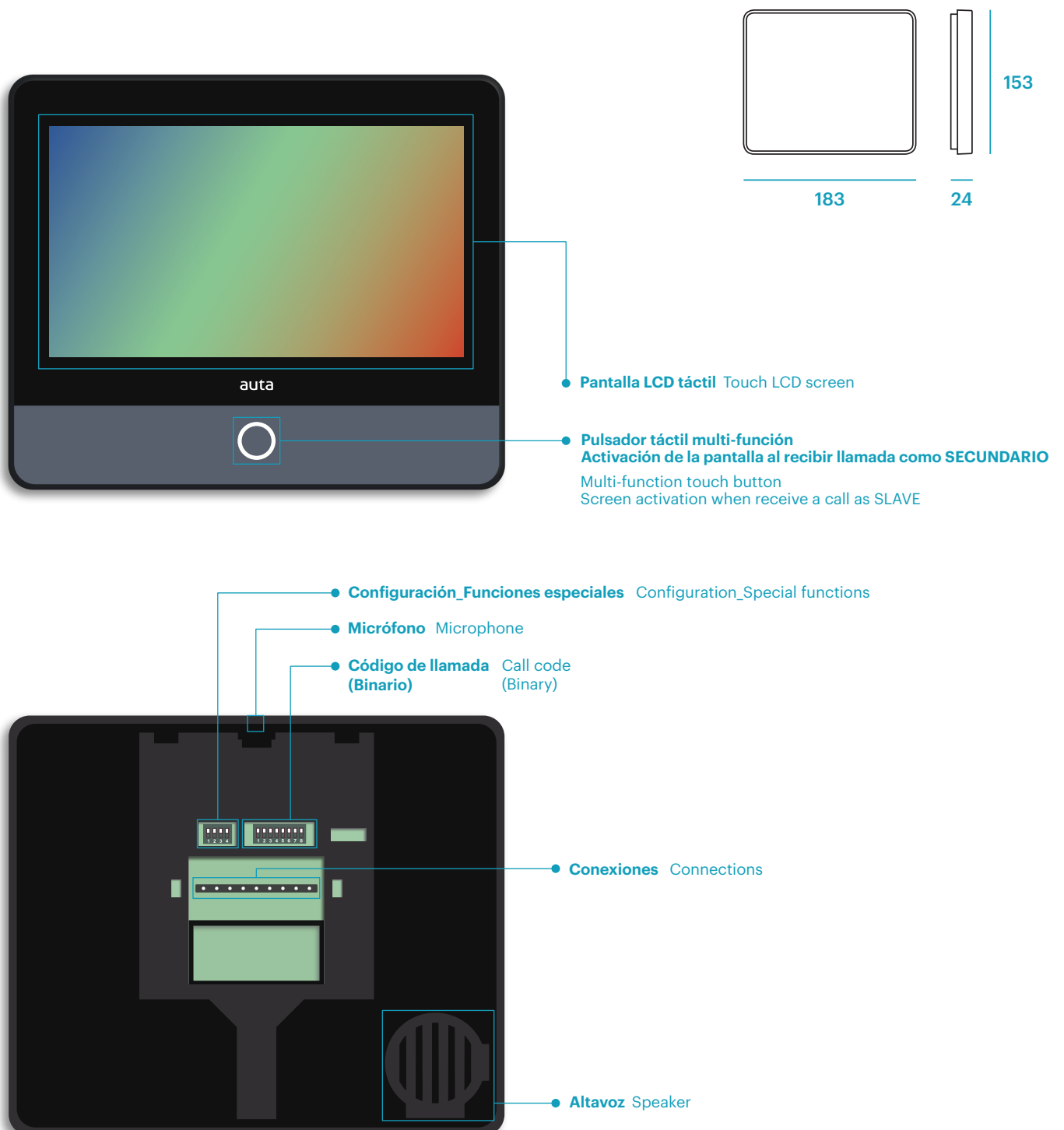

Montaje Mounting

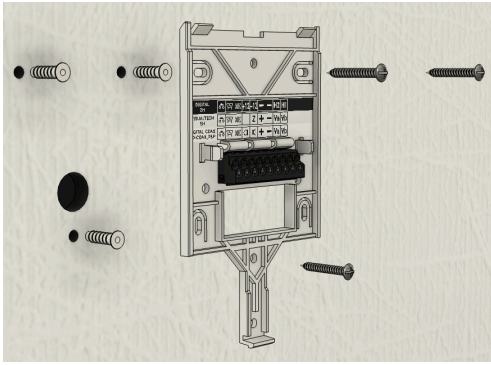

Soporte NO INCLUIDO
Bracket NOT INCLUDED

1

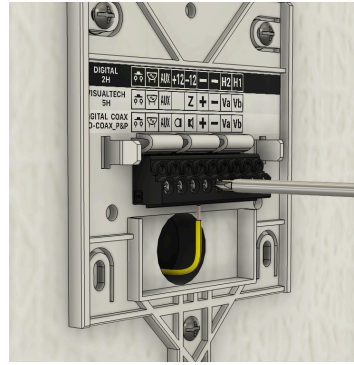

2



3

Instalación Installation

Monitor como principal Monitor as main

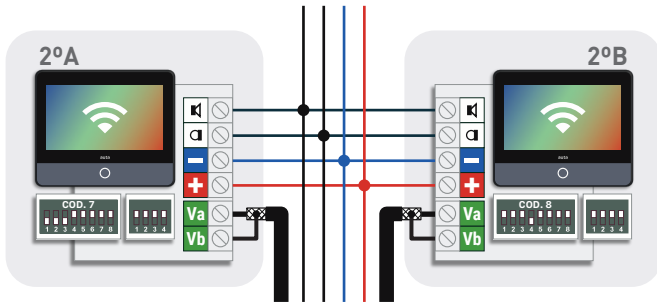

Monitor como secundario Monitor as secondary

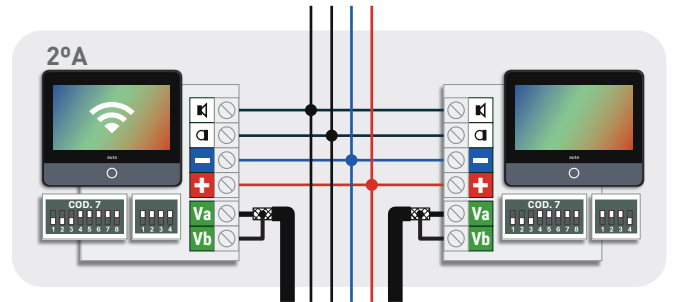

Manual de instalación VIDEO COAX
Installation manual VIDEO COAX

Configuración Configuration

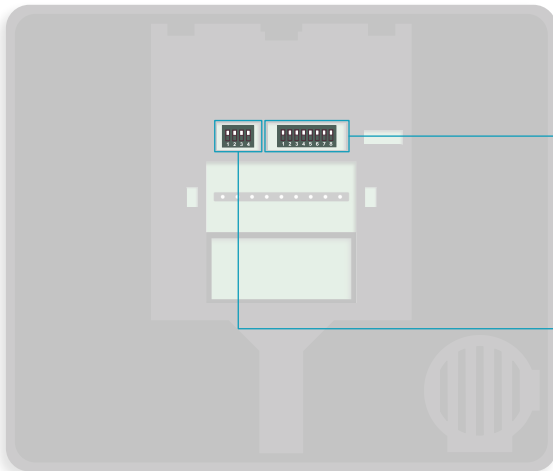

Configuración del sistema digital
Digital system configuration



Principal
Main



Secundario
Secondary



Carga video ON
Video load ON



Carga video OFF
Video load OFF

Funcionamiento Functioning

activación del monitor activation of the monitor

EN REPOSO, para prevenir pulsaciones indeseadas, el monitor incorpora un sistema de seguridad en el que la pantalla táctil permanece bloqueada hasta que se presiona el pulsador . Si se presiona durante 10 segundos el monitor se re-iniciará.

IN STANDBY, to prevent unwanted keystrokes, the monitor incorporates a security system in which the touch screen remains locked until the button  is pressed. If it is pressed for 10 seconds the monitor will restart.

menú de usuario user menu

Al presionar el pulsador de activación  el monitor nos ofrece 4 opciones en pantalla e iconos activos en su barra de estado.

By pressing the activation button  the monitor offers us 4 options in screen and active icons in its status bar.

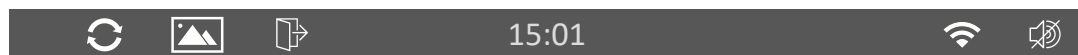

 **Actualización disponible. Presionar.**
Available update. Press.

 **Llamadas perdidas. Presionar.**
Miss calls. Press.

 **Función apertura automática disponible. Consultar ajustes avanzados.**
(versión uP: V1-230419_uC: V1-230419 y posterior)
Automatic opening function available. Consult advanced settings.
(version uP: V1-230419_uC: V1-230419 and later)

 **Apertura desactivada. Presionar para activar**
Opening disabled. Press to activate.

 **Apertura activa (durante 4 horas)**
Opening active (during 4 hours)

15:01 Hora sincronizada de forma automática por nuestros servidores.
Time automatically synchronized by our servers.

 **Indicador multi-estado de conexión Wi-Fi.**
Multi-state indicator for Wi-Fi connection.

 **Módulo Wi-Fi conectado.** Wi-Fi module connected.

 **Módulo Wi-Fi desconectado.** Wi-Fi module disconnected.

 **Llamada a terminal móvil activa.** Call to mobile terminal active.

 **Indicador de estado para los tonos de llamada. Presionar.**
State indicator for the calling tones. Press.

 **Modo estándar, tonos de llamada activos.**
Standard mode, calling tones active.

 **Modo "No molestar".** Mode "Not disturb".

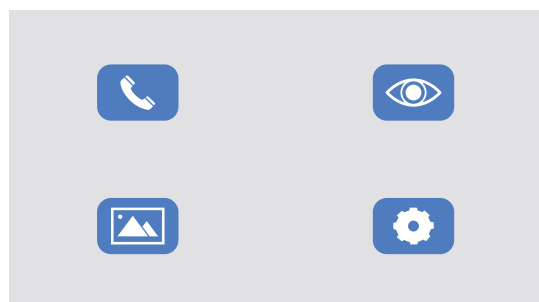

 **Al presionar accedemos al menú de llamadas.**
By pressing we access to the calls menu.

 **Llamada a conserjería**
Call to concierge

 **Llamada monitor a móvil**
Call monitor to mobile
(Próximamente. Coming soon)

 **Llamada monitor a monitor**
Call monitor to monitor
(Próximamente. Coming soon)

 **Auxiliar**
Auxiliary

 **Presionando accedemos a la placa o cámara en la que estemos vinculados.**
By pressing we access to the Panel_Camera in which we are linked.

 **Presionando accedemos a la galería de imágenes almacenadas. Podremos elegir la Placa_Cámara cuyas imágenes queremos visualizar.**
By pressing we access to the gallery of stored images. We can choose the Panel_Camera whose images we want to visualize.

 **Presionando accedemos al menú de configuración del monitor.**
By pressing we access to the monitor configuration menu.

 **Ajuste de volumen y melodías**
Melody and Volume settings

 **Gestión de Wi-Fi**
Wi-Fi management

 **Vinculación del monitor**
Monitor pairing.
APP Auta ONEX Wi-Fi

 **Información de sistema. Descarga de aplicaciones.**
System info. Download APP's

 **Ajustes avanzados**
Contraseña: **1234**
Advanced settings
Password: **1234**

 **Ajuste de franja horaria**
Defecto: **España**
Time zone setting
Default: **Spain**

 **Actualizar monitor**
Monitor update



Guía rápida APP
APP quick guide



opciones durante la llamada

Cuando se recibe una llamada desde una Placa_Conserje, las siguientes opciones estarán disponibles.



Al presionar podemos accionar la apertura del dispositivo que estemos viendo en pantalla.



Al presionar abriremos el canal de comunicación.



Al presionar finalizaremos la conversación en curso y el monitor pasará a reposo.



Al presionar podemos accionar la apertura del dispositivo que estemos viendo en pantalla.



Al presionar accionaremos la salida auxiliar del monitor.



Al presionar accederemos al menú de ajuste de imagen, brillo, color y contraste. Para salir del menú deberemos presionar el botón de guardar.

Pulsar para cambiar de menú

opciones durante la conversación

Cuando se establece una conversación con una Placa_Conserje_Cámara, las siguientes opciones estarán disponibles.



Al presionar podemos accionar la apertura del dispositivo que estemos viendo en pantalla.



Al presionar podemos visualizar y recorrer las placas o cámaras en la que estemos enlazados.



Al presionar finalizaremos la conversación en curso y el monitor pasará a reposo.



Al presionar podemos silenciar el audio que emite el monitor. Ofreciendo así privacidad siempre que se desee.



Al presionar accionaremos la salida auxiliar del monitor.



Al presionar accederemos al menú de ajuste de imagen, brillo, color y contraste. Para salir del menú deberemos presionar el botón de guardar.

Pulsar para cambiar de menú

options during the call

When a call is received from a Concierge_Panel, the following options will be available.



By pressing we can activate the opening of the device that we are seeing on the screen.



By pressing we will open the communication channel.



Pressing will end the conversation in progress and the monitor will go to standby.



By pressing we can activate the opening of the device that we are seeing on the screen.



When pressing we will activate the auxiliary output of the monitor.



By pressing we will access the image, brightness, color and contrast adjustment menu. To exit the menu we must press the save button.

Press to change the menu

options during the conversation

When establishing a conversation with a Panel_Concierge_Camera, the following options will be available.



By pressing we can activate the opening of the device that we are seeing on the screen.



By pressing we can visualize and go through the panel or cameras in which we are linked.



Pressing will end the conversation in progress and the monitor will go to standby.



By pressing we can mute the audio emitted by the monitor. Thus offering privacy whenever desired.



When pressing we will activate the auxiliary output of the monitor.



By pressing we will access the image, brightness, color and contrast adjustment menu. To exit the menu we must press the save button.

Press to change the menu