

onex

IP

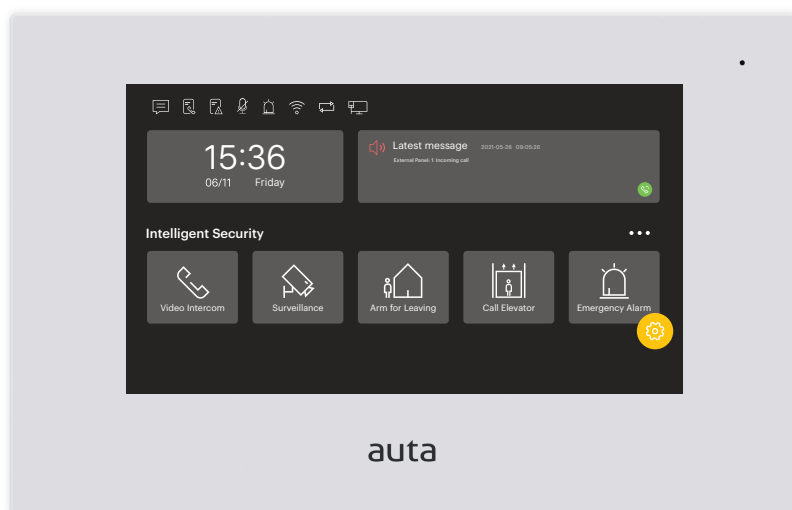

REF: 751004

ES MONITOR ONEX IP Wi-Fi

EN Wi-Fi ONEX IP MONITOR

PT MONITOR ONEX IP Wi-Fi

FR MONITOR ONEX IP Wi-Fi

auta

Bringing people together

General

ES

Descripción	2
Características	2
Elementos	2
Dimensiones	2

Funcionamiento

MENU	3
CONTRASEÑAS	3
ADMINISTRADOR	
CONFIGURACIÓN	

NOTA DE APLICACIÓN

Enlazar placa ONEX IP PULSADOR	10
Agregar monitor a Tuya SMART	11

General

EN

Description	4
Characteristics	4
Elements	4
Dimensions	4

Functioning

MENU	5
PASSWORDS	5
ADMINISTRATOR	
CONFIGURATION	

APPLICATION NOTE

Link ONEX IP PUSHBUTTON panel	10
Add monitor to Tuya SMART	11

Geral

PT

Descrição	6
Características	6
Elementos	6
Dimensões	6

Funcionamento

MENU	7
SENHAS	7
ADMINISTRADOR	
CONFIGURAÇÃO	

NOTA DE APLICAÇÃO

Link placa ONEX IP BOTÃO	10
Adicionar monitor ao Tuya SMART	11

Général

FR

Description	8
Caractéristiques	8
Éléments	8
Dimensions	8

Fonctionnement

MENU	9
MOTS DE PASSE	9
ADMINISTRATEUR	
RÉGLAGE	

NOTE D'APPLICATION

Lier la plaque ONEX IP BOUTON	10
Ajouter un moniteur à Tuya SMART	11

General

Descripción

Monitor Autá ONEX IP. Permite ser instalado en cualquier sistema IP Autá. Compatible con tecnología IP Clase A. Incorpora sistema de comunicación manos libre Full DUPLEX y pantalla táctil.

Características

Pantalla: LCD 7" con tecnología táctil

Audio: Sistema manos libres Full DUPLEX

Alimentación: 24 Vcc, 350 mA PoE 48V

Temperatura: - 10 °C + 55 °C

Controles: tecnología capacitiva de alta precisión

Sistema operativo: Android 6.0.1

Elementos

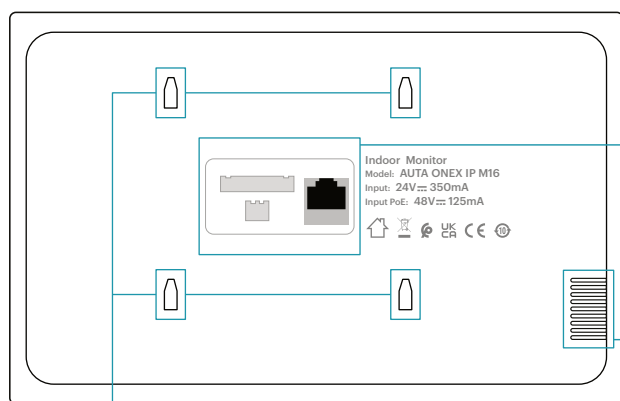
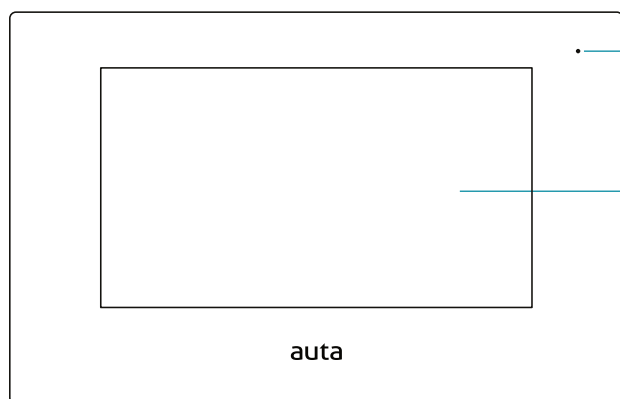

● **Micrófono**

● **Pantalla**

● **Conexiones**

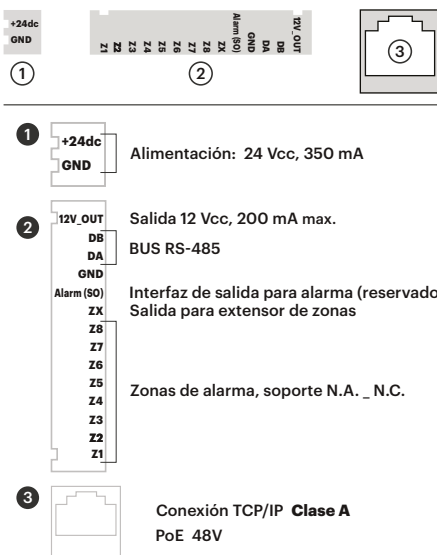

● **Altavoz**

● **Fijación para soporte de pared**

Dimensiones

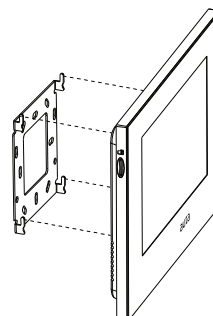
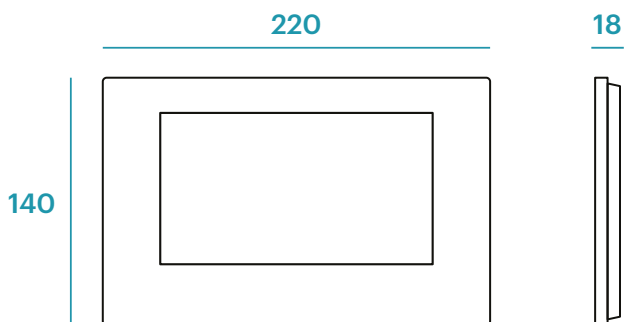

Funcionamiento

CONTRASEÑAS

ADMINISTRADOR



CONFIGURACIÓN



MENU

• **Iconos de acceso rápido e información**

- Mensajes
- Llamadas
- Alarmas
- Silenciar micrófono
- Activar alarma
- Desvío de llamadas
- Conexión Wi-Fi
- Estado de la red

• **Listado de eventos**

• **Todas las funciones**

• **Ajustes del sistema**

Pulsadores de acceso rápido



En esta sección podremos establecer comunicación con una Vivienda o Casa, un monitor interior de nuestra propia vivienda o con Conserjería.



En esta sección podremos activar cualquier cámara, tanto de una placa como cctv, presente en la instalación.



En esta sección podremos gestionar el sistema de seguridad de nuestra vivienda en caso de haberlo vinculado con el monitor Onex IP M16.

1 detector por zona

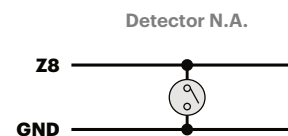
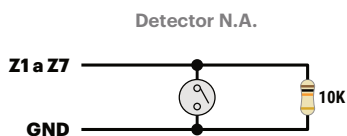
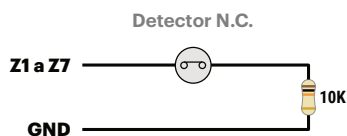

Varios detectores por zona

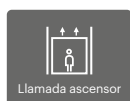
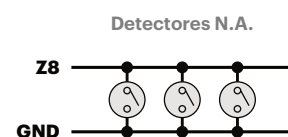
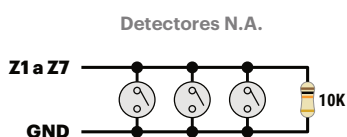
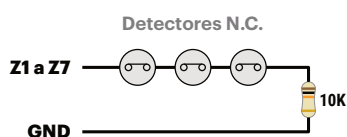

En esta sección podremos gestionar el sistema de ascensor de nuestro edificio en caso de haberlo vinculado con el monitor Onex IP M16.



Realizando un pulsación prolongada podremos realizar una llamada de emergencia a la central de conserjería.

General

Description

Auta ONEX IP monitor. It can be installed in any Autata IP system. Compatible with IP Class A technology. It incorporates a Full DUPLEX hands-free communication system and a touch screen.

Characteristics

Screen: LCD 7" with touch technology

Audio: Full DUPLEX hands-free system

Supply: 24 Vdc, 350 mA PoE 48V

Temperature: - 10 °C + 55 °C

Controls: high precision capacitive technology

Operating system: Android 6.0.1

Elements

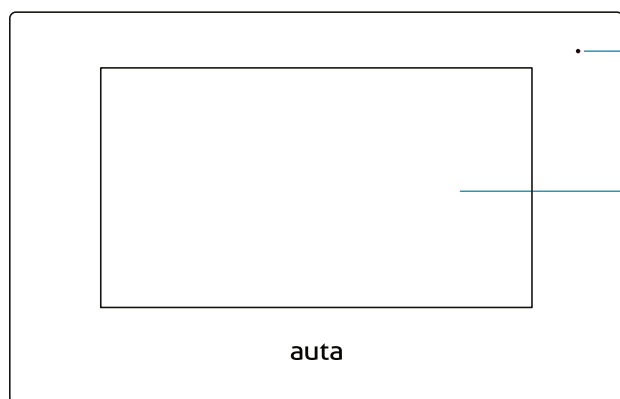

• Microphone

• Screen

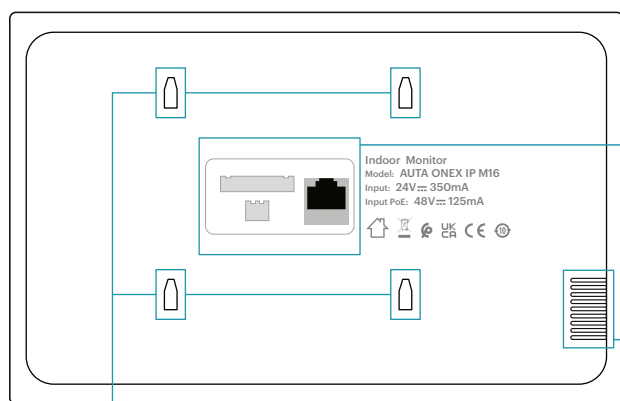

Indoor Monitor
Model: AUTA ONEX IP M16
Input: 24V \pm 350mA
Input PoE: 48V \pm 125mA

Connections

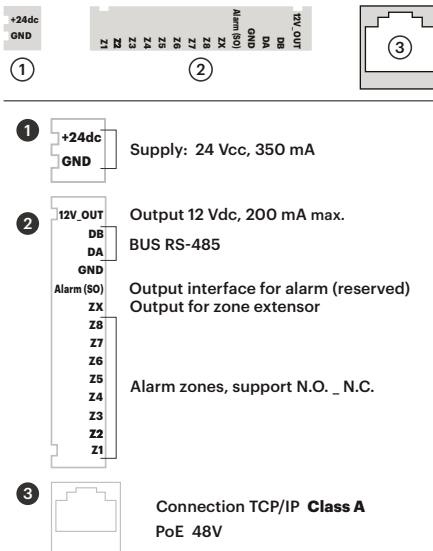

• Speaker

• Fixing for wall bracket

Dimensions

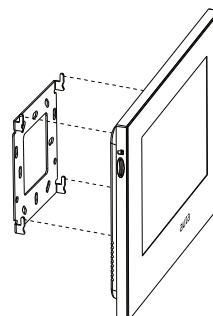
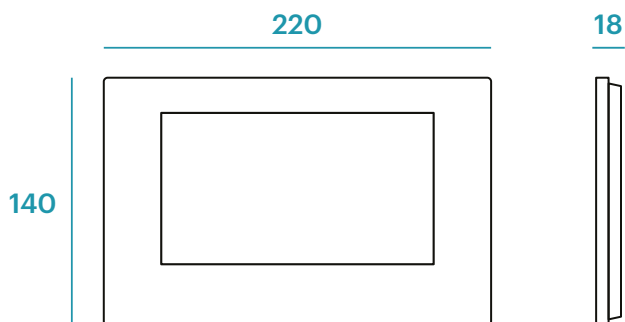

Functioning

PASSWORDS

ADMINISTRATOR



CONFIGURATION



MENU

• Icons quick access and information

- Messages
- Alarm activation
- Calls
- Calls divert
- Alarms
- Wi-Fi connection
- Silence microphone
- Network state

• Events list

• All functions

• System settings

Quick access push-buttons

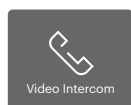

In this section we can establish communication with a Housing or Villa, an interior monitor of our own housing or with a Concierge.



In this section we will be able to activate any camera, from a panel or cctv, present in the installation.



In this section we can manage the security system of our home if it has been linked to the Onex IP M16 monitor.

1 detector by zone

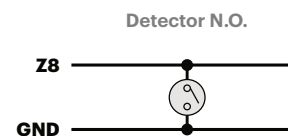
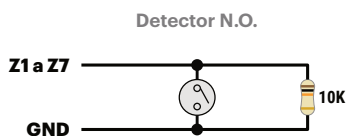
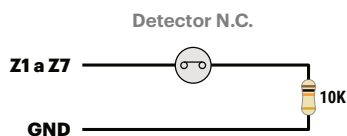

Several detectors by zone

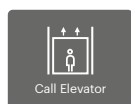
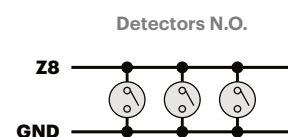
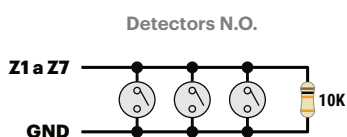
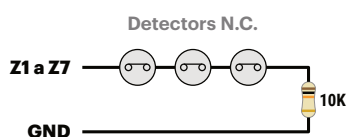

In this section we will be able to manage the elevator system of our building if it has been linked to the Onex IP M16 monitor.



With a long press we can make an emergency call to the concierge.

Geral

Descrição

Monitor Auta ONEX IP. Pode ser instalado em qualquer sistema Auta IP. Compatível com a tecnologia IP Classe A. Incorpora um sistema de comunicação mãos-livres Full DUPLEX e um ecrã táctil.

Características

Tela: LCD 7" com tecnologia de toque

Audio: Sistema mãos-livres Full DUPLEX

Alimentação: 24 Vcc, 350 mA PoE 48V

Temperatura: - 10 °C + 55 °C

Controles: tecnologia capacitiva de alta precisão

Sistema operacional: Android 6.0.1

Elementos

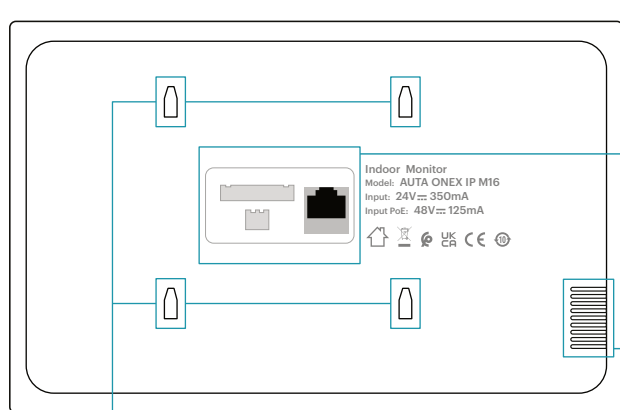
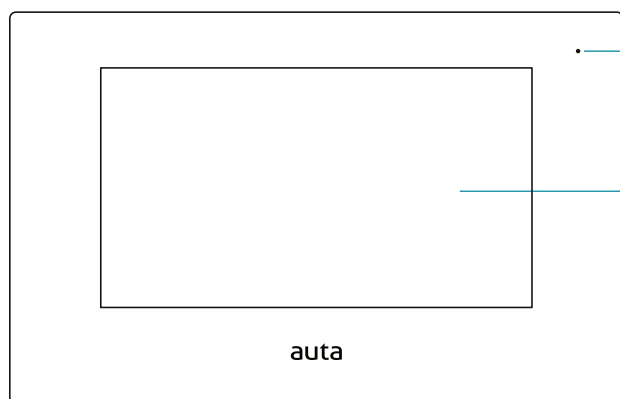

Conexões

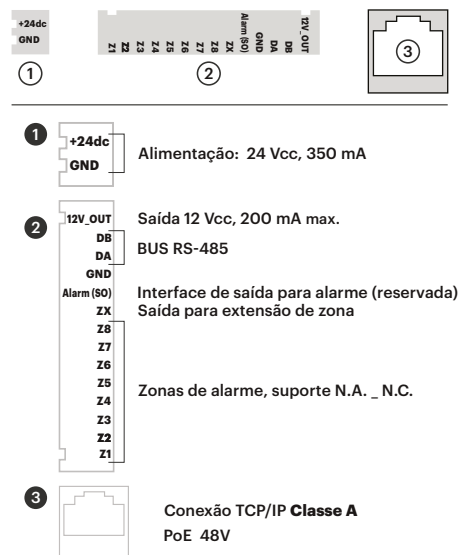

Alto-falante

Fixação para suporte de parede

Dimensões

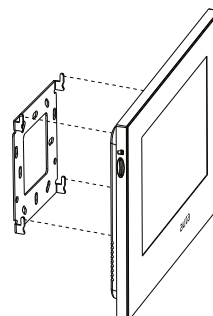
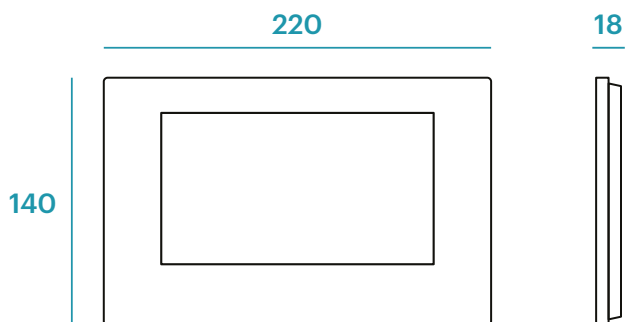

Funcionamento

SENHAS

ADMINISTRADOR



CONFIGURAÇÃO



MENU

Acesso rápido e ícones de informação

- Mensagens
- Chamadas
- Alarmes
- Microfone mudo
- Ativar alarme
- Desvio de chamada
- Conexão Wi-Fi
- Status da rede

Lista de eventos

Todas as funções

Configurações do sistema

Botões de acesso rápido



Nesta seção, podemos estabelecer comunicação com uma Habitação ou Casa, um monitor interno de nossa própria casa ou com um Concierge.



Nesta seção poderemos ativar qualquer câmera, tanto de placa como de cctv, presente na instalação.



Nesta seção, podemos gerenciar o sistema de segurança da nossa casa se ele estiver conectado ao monitor Onex IP M16.

1 detector por zona

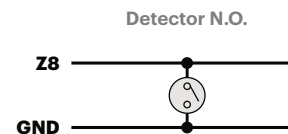
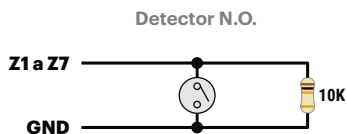
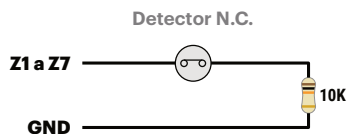

Vários detectores por zona

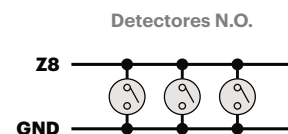
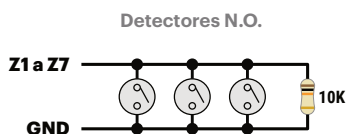
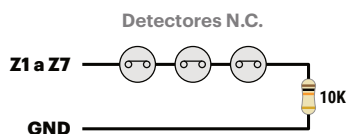

Nesta seção, seremos capazes de gerenciar o sistema de elevador de nosso prédio se ele estiver conectado ao monitor Onex IP M16.



Com um toque longo, podemos fazer uma chamada de emergência para o concierge.

Général

Description

Moniteur Auta ONEX IP. Il peut être installé dans n'importe quel système IP Auta. Compatible avec la technologie IP Classe A. Il intègre un système de communication mains libres Full DUPLEX et un écran tactile.

Caractéristiques

Écran: Écran LCD de 10,1 po avec technologie tactile

Audio: Système mains libres Full DUPLEX

Alimentation: 24 Vcc, 300 mA PoE 48V

Température: - 10 °C + 55 °C

Contrôles: technologie capacitive de haute précision

Système opératif: Android 6.0.1

Éléments

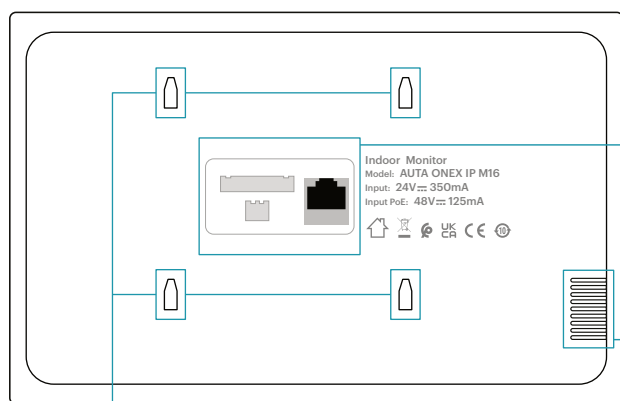
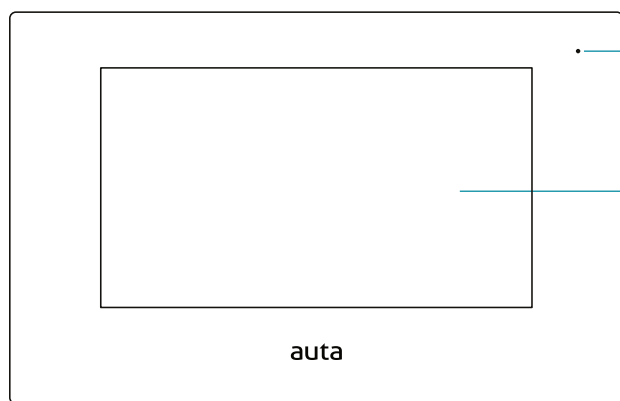

● Microphone

● Écran

Connexions

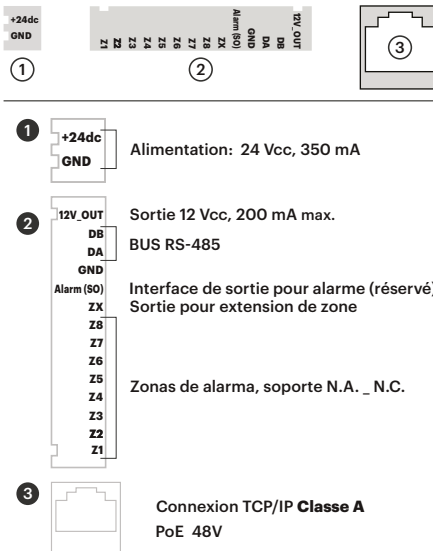

● Haut-parleur

● Fixation pour support mural

Dimensions

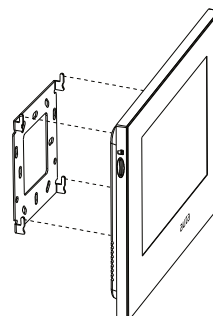
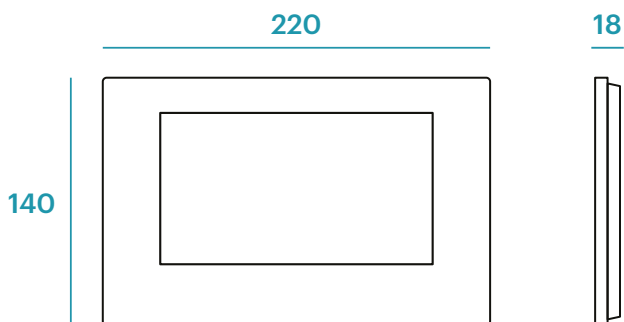

Fonctionnement

MOTS DE PASSE

ADMINISTRATEUR



RÉGLAGE



MENU

• Icônes d'accès rapide et d'information

- Messages
- Appels
- Alarmes
- Couper le micro
- Activer l'alarme
- Renvoi d'appel
- Connexion Wi-Fi
- L'état du réseau

• Liste des événements

• Toutes les fonctions

• Les paramètres du système

Boutons d'accès rapide



Dans cette section, nous pouvons établir une communication avec une Logement ou une Maison, un moniteur d'intérieur de notre propre maison ou avec un concierge.

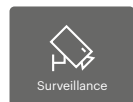

Dans cette section, nous pourrions activer n'importe quelle caméra, à la fois à partir d'une plaque et de vidéosurveillance, présente dans l'installation.



Dans cette section, nous pouvons gérer le système de sécurité de notre maison s'il a été lié au moniteur Onex IP M16.

1 détecteur par zone

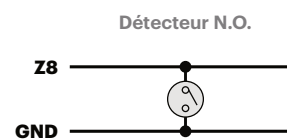
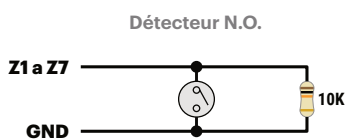
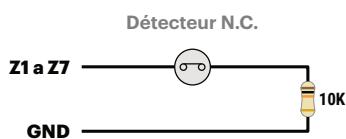

Plusieurs détecteurs par zone

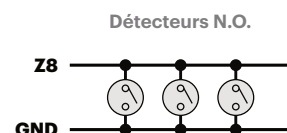
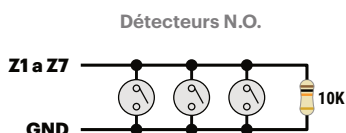
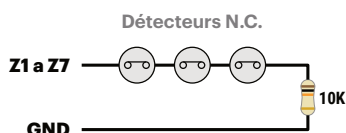

Dans cette section, nous pourrions gérer le système d'ascenseur de notre bâtiment s'il a été relié au moniteur Onex IP M16.



Avec un appui long, nous pouvons faire un appel d'urgence à la conciergerie.

1

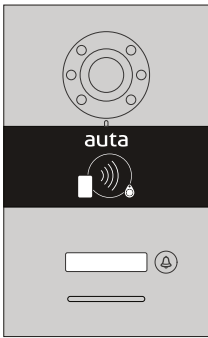

Configurar la placa ONEX IP PULSADOR en modo programación (manual de la placa).

Configure the ONEX IP PUSH-BUTTON panel in programming mode (panel manual).

Configure a placa ONEX IP BOTÃO em modo de programação (manual da placa).

Configurer la carte ONEX IP BUTTON en mode programmation (manuel de la plaque).

2

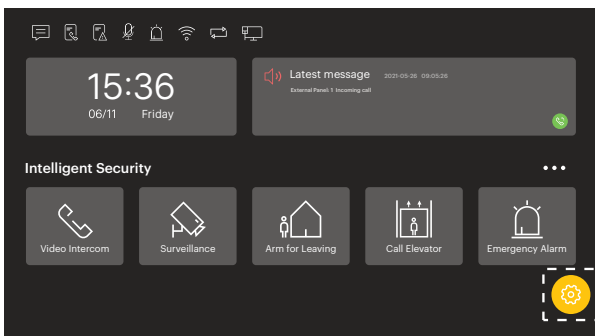

Ajustes

Settings

Configurações

Paramètres

3

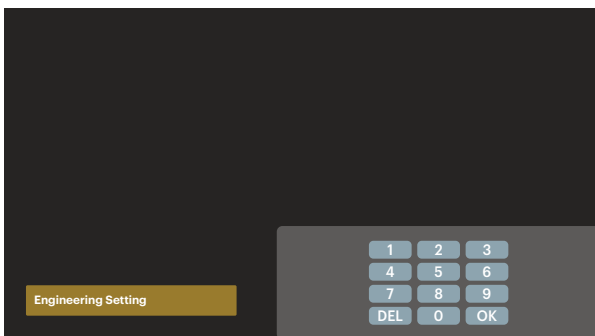

Configuración de ingeniería (contraseña por defecto 801801)

Engineering setting (default password 801801)

Configuração de engenharia (senha padrão 801801)

Réglage d'ingénierie (mot de passe par défaut 801801)

4

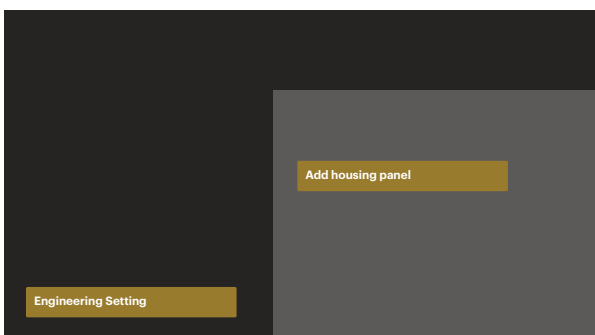

Seleccionamos "Añadir Placa de Vivienda"

We select "Add Housing Panel"

Selecionamos "Adicione a Placa de Habitação"

Nous sélectionnons "Ajouter une Plaque de Logement"

5

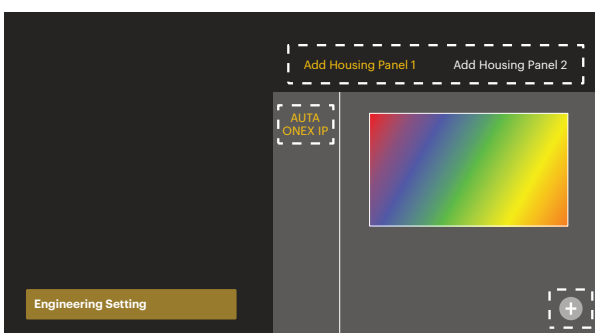

Seleccionamos la posición de memoria (Placa 1 o Placa 2). El monitor detectará la placa en modo programación. La seleccionaremos y la imagen aparecerá. Si es nuestra placa, pulsaremos "+" para vincular con nuestro monitor.

We select the memory position (Panel 1 or Panel 2). The monitor will detect the board in programming mode. We will select it and the image will appear. If it is our panel, we will press "+" to link with our monitor.

Selecionamos a posição da memória (Placa 1 ou Placa 2). O monitor detectará a placa no modo de programação. Iremos selecioná-lo e a imagem aparecerá. Se for a nossa placa, pressionaremos "+" para vincular ao nosso monitor.

Nous sélectionnons la position mémoire (Plaque 1 ou Plaque 2). Le moniteur détectera la plaque en mode programmation. Nous le sélectionnerons et l'image apparaîtra. S'il s'agit de notre plaque, nous appuierons sur "+" pour établir la liaison avec notre moniteur.

1



751004

Añadir monitor ONEX IP Wi-Fi (751004) en APP Tuya Smart.

Add ONEX IP Wi-Fi monitor (751004) in the Tuya Smart APP.

Adicione o monitor ONEX IP Wi-Fi (751004) no Tuya Smart APP.

Ajoutez le moniteur Wi-Fi IP ONEX (751004) dans l'application Tuya Smart.



2

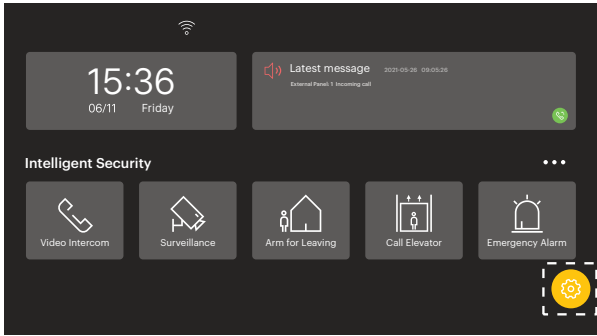

Ajustes → WLAN, conectamos el terminal a nuestro Wi-Fi.

Settings → WLAN, connect the device to our Wi-Fi.

Configurações → WLAN, conectar o terminal ao nosso Wi-Fi.

Paramètres → WLAN, connecter le terminal à notre Wi-Fi.

3

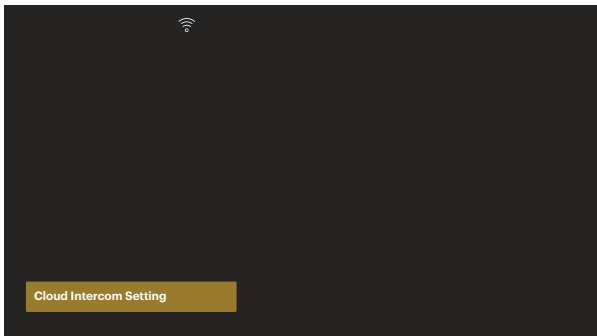

Ajustes → Configuración nube → Servidor EU, esperamos a que el monitor reinicie.

Settings → Cloud Intercom Setting → EU server, we wait for the monitor to restart.

Configurações → Configuração da nuvem → Servidor da UE, esperamos o monitor reiniciar.

Paramètres → Paramètres Cloud Intercom → Serveur EU, nous attendons que le moniteur redémarre.

4

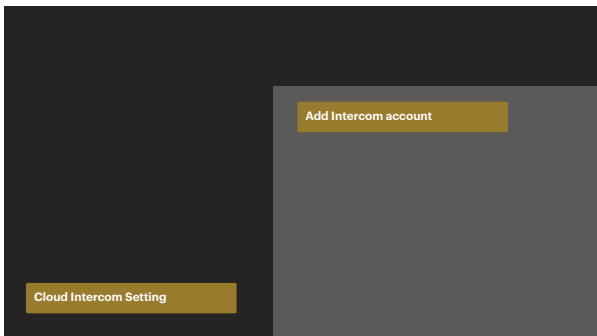

Agregamos cuenta Intercom.

Add Intercom account.

Adicionamos a conta Intercom.

Ajoutons un compte Intercom.

5

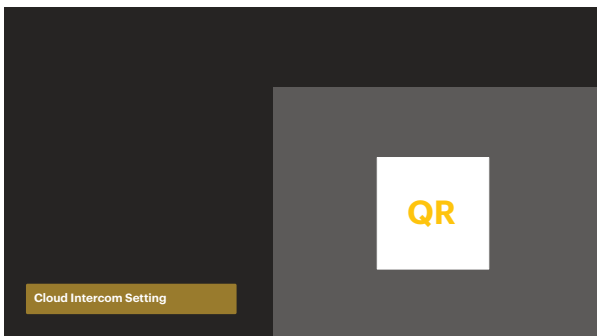

Abrimos la APP Tuya Smart y escaneamos el código QR de activación que nos muestra en pantalla el monitor.

We open the Tuya Smart APP and scan the activation QR code that the monitor shows us on the screen.

Abrimos o APP Tuya Smart e escadeamos o código QR de ativação que o monitor nos mostra na tela.

Nous ouvrons l'application Tuya Smart et scannons le code QR d'activation que le moniteur nous montre à l'écran.